

SANYO

No.1415C



LA5000M Series

Monolithic Linear IC

2 to 10V 60mA
Low Saturation Voltage Regulators

The LA5002M, 5003M, 5004M, 5005M, 5006M, 5008M, 5009M, 5010M are voltage regulators having a small input-output voltage drop (0.2V typ.). They are especially suited for use in battery-powered low voltage equipment and commercial or industrial equipment having a large voltage regulation.

Features

- . Small input-output voltage drop (0.2V/I_{OUT}=20mA typ.)
- . Minimum number of external parts required
- . Highly resistant against load short
- . Radio noise (radiation) control pin

Maximum Ratings at Ta=25°C

			unit
Input Supply Voltage	V _{IN} max	LA5002M, 5003M, 5004M, 5005M	12 V
		LA5006M, 5008M, 5009M, 5010M	16 V
Output Current	I _{OUT} max		60 mA
Allowable Power Dissipation	P _d max		300 mW
Operating Temperature	Topg		-20 to +80 °C
Storage Temperature	Tstg		-30 to +125 °C

Operating Characteristics at Ta=25°C, C_{OUT}=10uF, I_{OUT}=20mA, V_{IN}=3V[LA5002M], V_{IN}=4V [LA5003M], V_{IN}=5V[LA5004M], V_{IN}=6V[LA5005M], V_{IN}=7V[LA5006M], V_{IN}=9V[LA5008M], V_{IN}=10V[LA5009M], V_{IN}=11V[LA5010M]

			min	typ	max	unit
Output Voltage	Vo	LA5002M	1.85	2.0	2.15	V
		LA5003M	2.8	3.0	3.2	V
		LA5004M	3.75	4.0	4.25	V
		LA5005M	4.75	5.0	5.25	V
		LA5006M	5.7	6.0	6.3	V
		LA5008M	7.6	8.0	8.4	V
		LA5009M	8.55	9.0	9.45	V
		LA5010M	9.4	10.0	10.6	V
Line Regulation	Vo line	LA5002M 2.5V<V _{IN} <8V			50	mV
		LA5003M 3.5V<V _{IN} <9V			50	mV
		LA5004M 4.5V<V _{IN} <10V			50	mV
		LA5005M 5.5V<V _{IN} <11V			50	mV

Continued on next page.

Equivalent Circuit Block Diagram

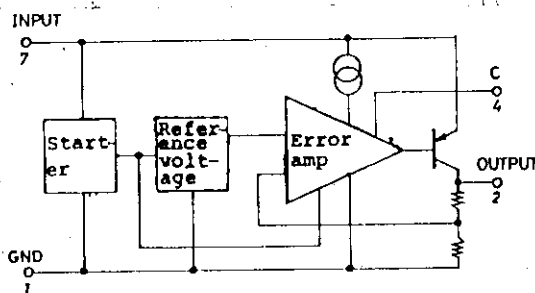

Case Outline 3032B-M8IC (unit:mm)

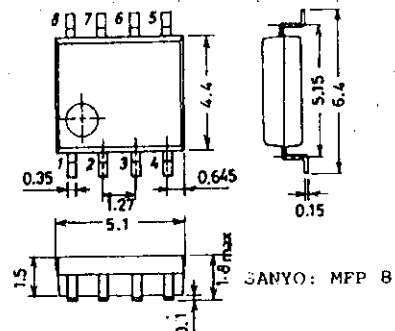

Specifications and information herein are subject to change without notice.

SANYO Electric Co., Ltd. Semiconductor Overseas Marketing Div.
Natsume Bldg., 18-6, 2-chome, Yushima Bunkyo-ku, TOKYO 113 JAPAN

LA5000M Series

Continued from preceding page.

			min	typ	max	unit
Line Regulation		LA5006M $6.5V < V_{IN} < 12V$			50	mV
		LA5008M $9V < V_{IN} < 14V$			50	mV
		LA5009M $10V < V_{IN} < 15V$			50	mV
		LA5010M $11V < V_{IN} < 16V$			50	mV
Load Regulation	V_o load	$1mA < I_{OUT} < 40mA$			20	mV
		$1mA < I_{OUT} < 50mA$			25	mV
Quiescent Current Dissipation	I_{CCO}	LA5002M	1.2	2.0		mA
		LA5003M	1.4	2.0		mA
		LA5004M	1.5	2.3		mA
		LA5005M, 5006M, 5008M, 5009M, 5010M	1.7	2.5		mA
Ripple Rejection	R_r	LA5002M, 5004M, 5005M $f=120Hz$	40			dB
		LA5003M $f=120Hz$	43			dB
		LA5006M, 5008M, 5009M, 5010M $f=120Hz$	35			dB
Input-Output Voltage Drop	V_{drop}		0.2	0.3		V
Temperature Coefficient of Output Voltage	$k\Delta v_o/\Delta T$	LA5002M, 5003M, 5004M, 5005M	-1			1 mV/°C
		LA5006M	-2			2 mV/°C
		LA5008M	-3			3 mV/°C
		LA5009M	-4			4 mV/°C
		LA5010M	-5			5 mV/°C
Output Noise Voltage	V_N	$10Hz < f < 100kHz$		30		uV

Sample Application Circuit

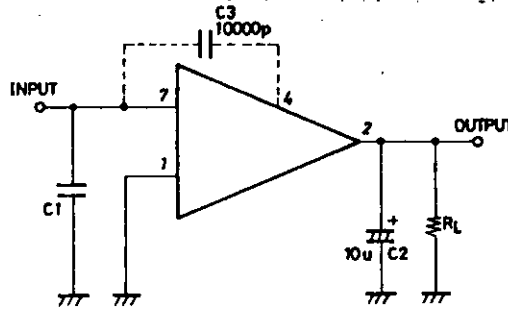

Note: Capacitor C3 is not required unless radio noise is a problem.

Test Circuits

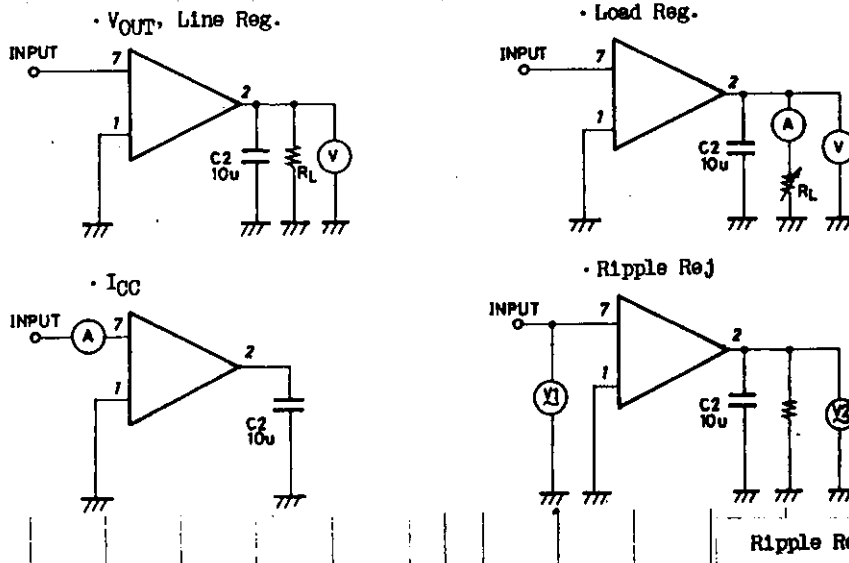

LA5000M Series

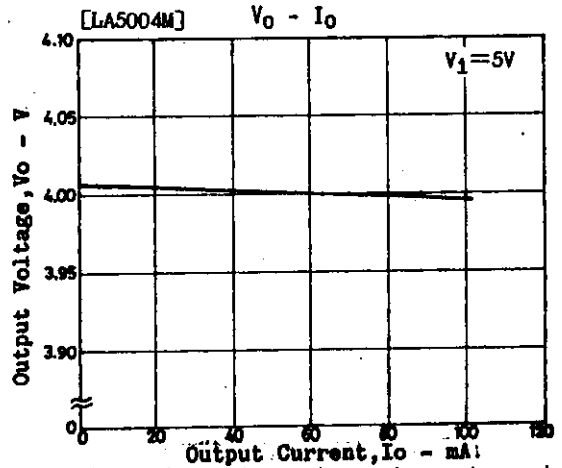
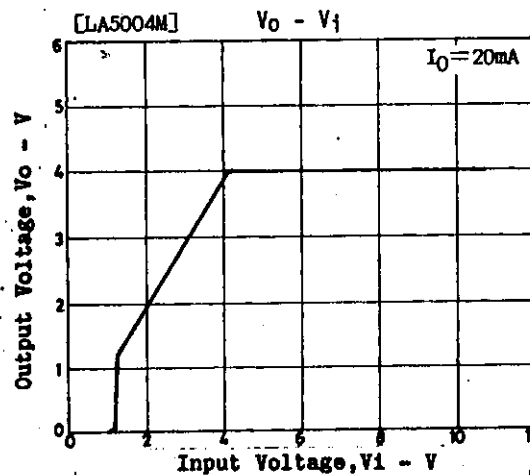
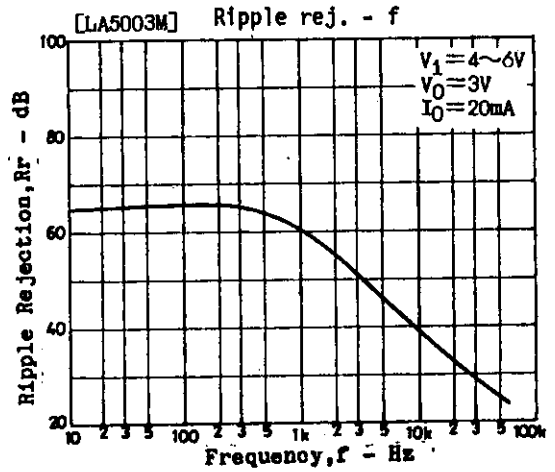
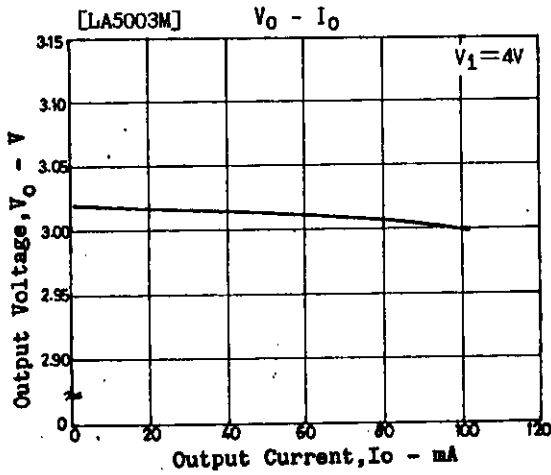
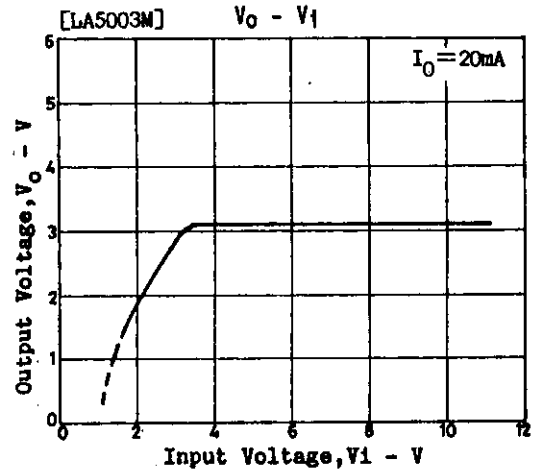
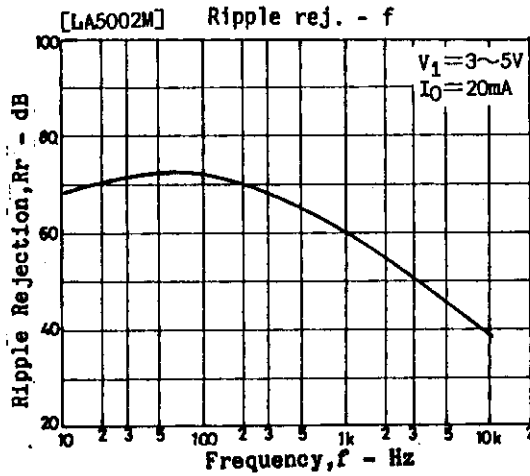
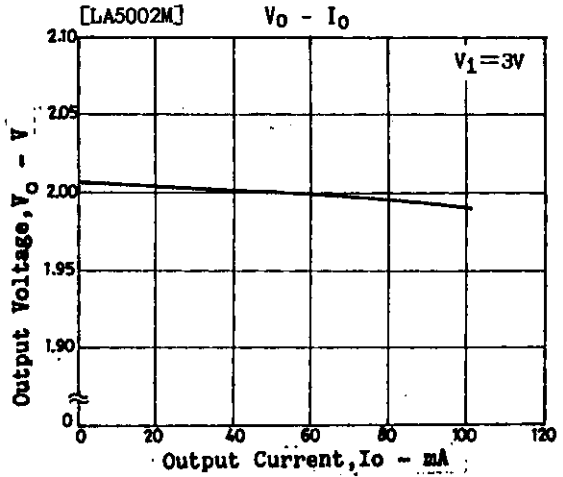
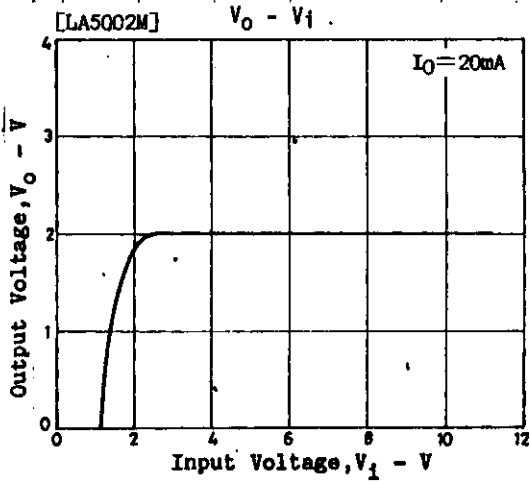

LA5000M Series

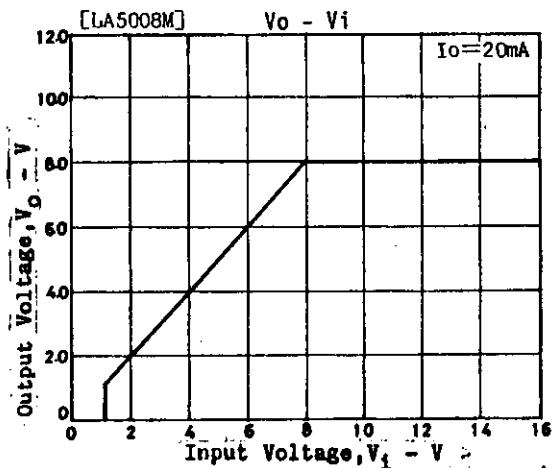
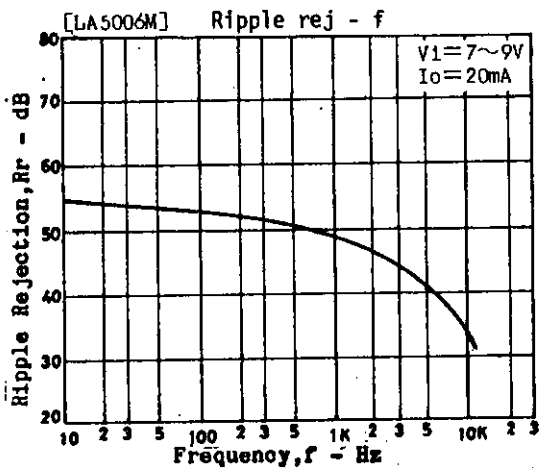
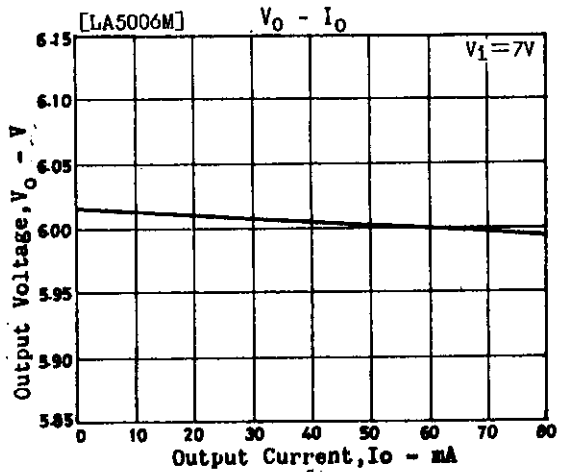
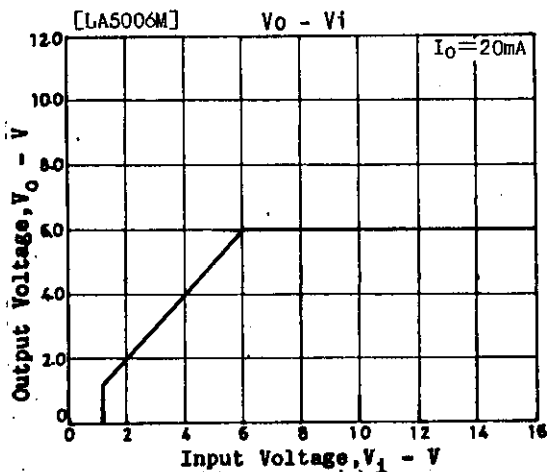
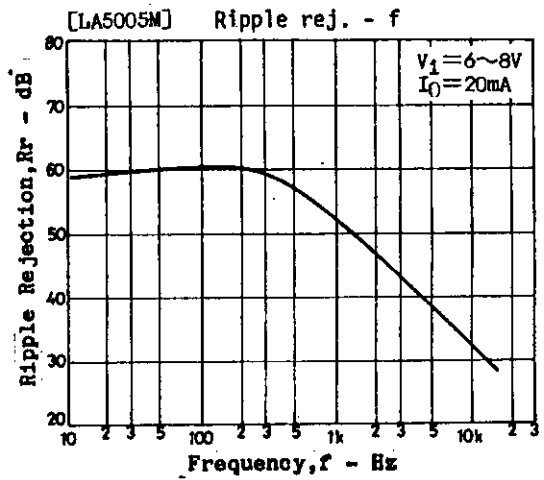
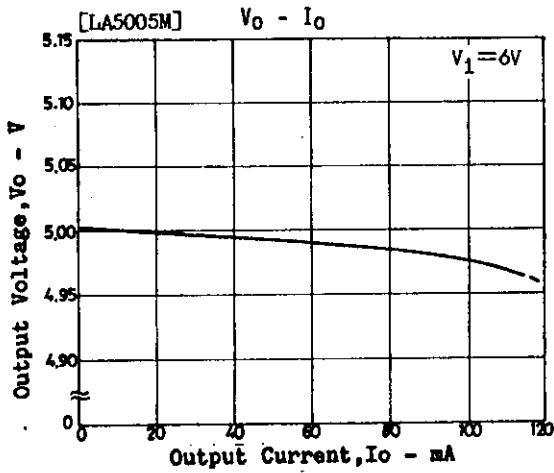
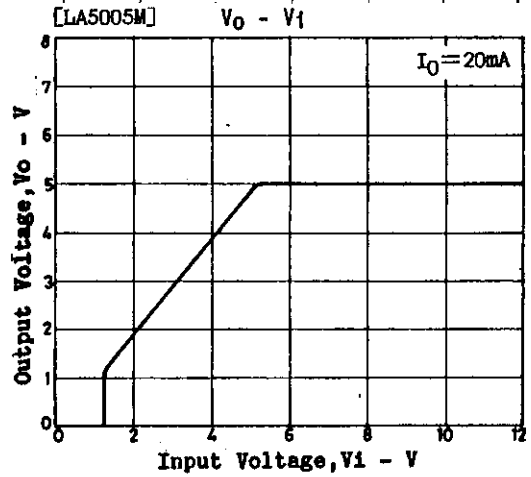
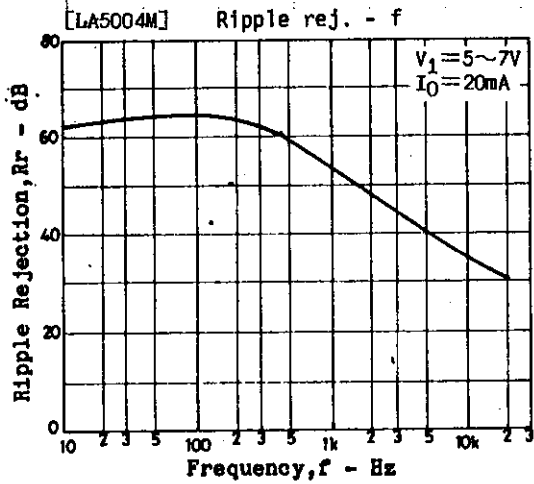

LA5000M Series

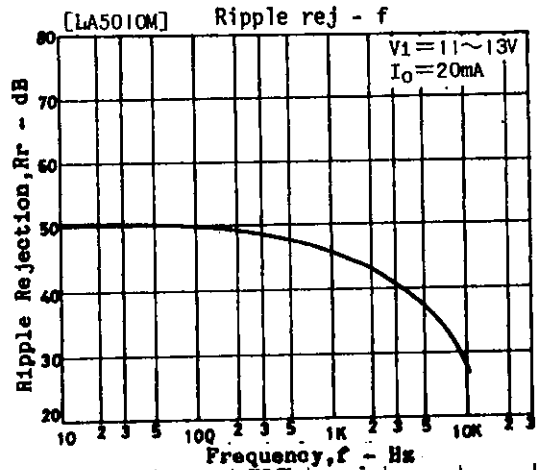
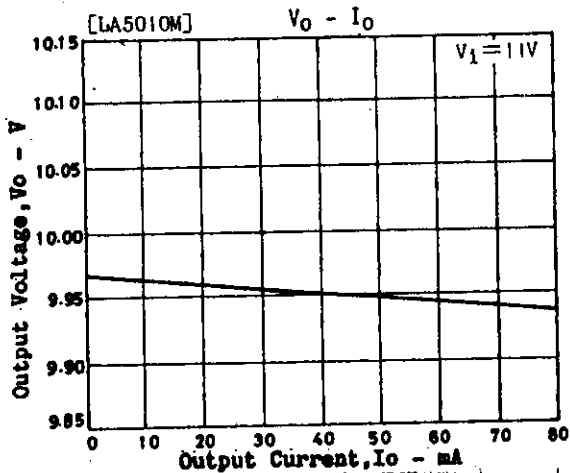
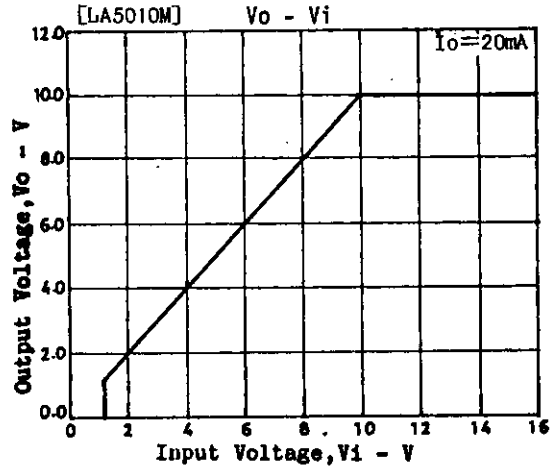
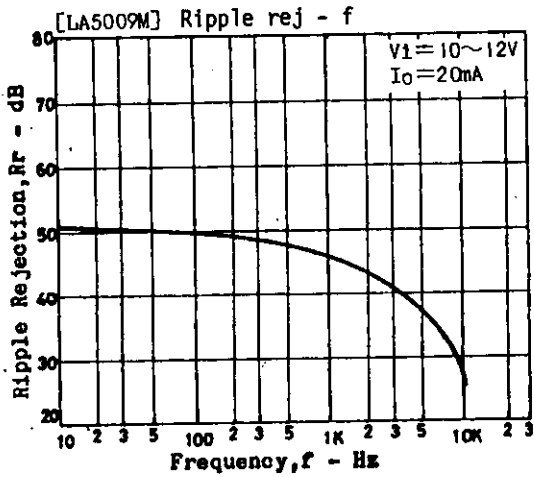
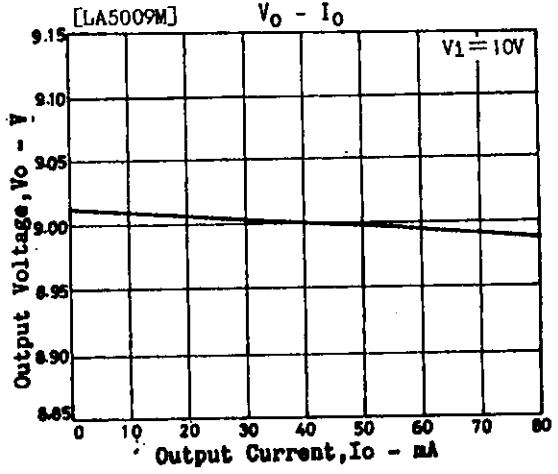
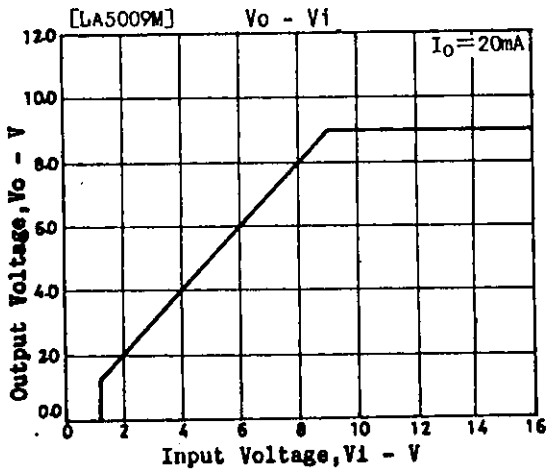
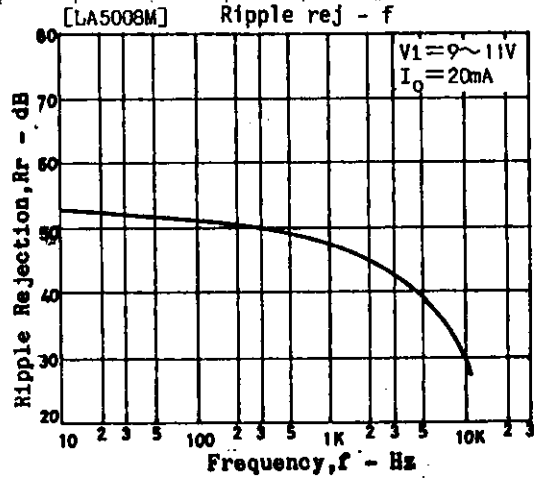
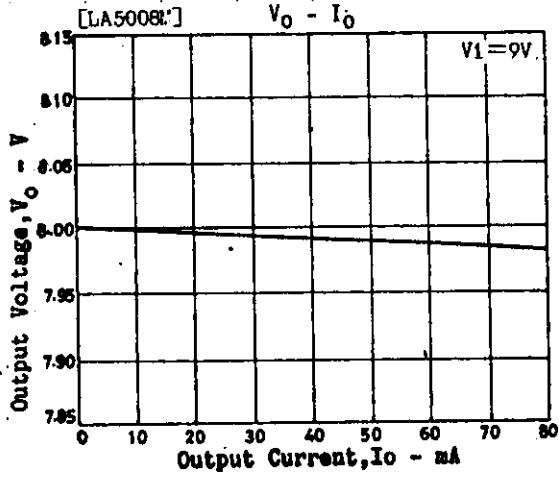

LA5000M Series

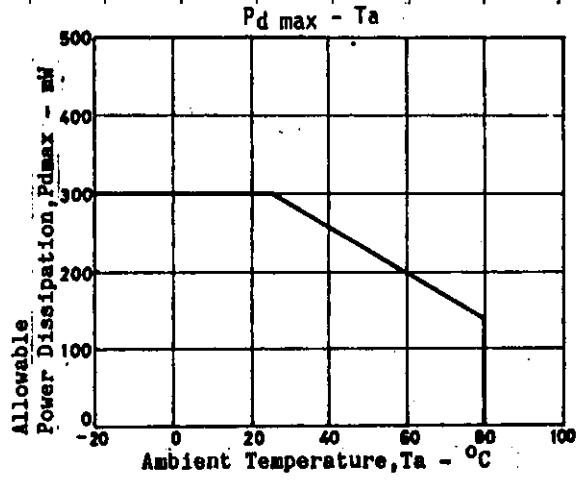
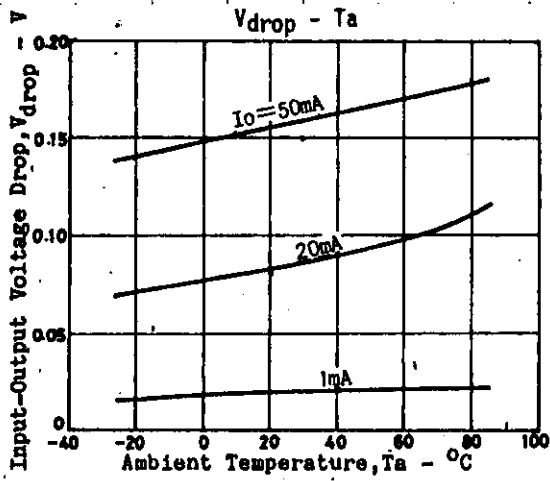

The application circuit diagrams and circuit constants herein are included as an example and provide no guarantee for designing equipment to be mass-produced.
 The information herein is believed to be accurate and reliable. However, no responsibility is assumed by SANYO for its use; nor for any infringements of patents or other rights of third parties which may result from its use.