

**KENWOOD**  
HI/FI STEREO COMPONENTS

# SERVICE MANUAL

## KT-917 (KT-9177)

An item of adjustment is written in three languages — English, French and German.

*Un article sur réglages est écrit en trois langues, Anglais, Français et Allemand.*

Ein Artikel der Abgleich wird auf drei Sprachen, Englische, Französisch und Deutsch geschrieben.

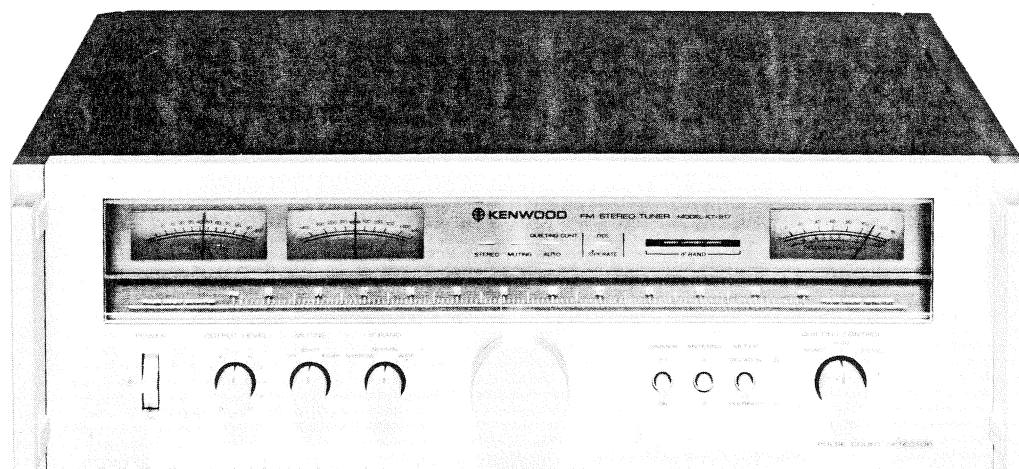

**FM STEREO TUNER**

## CONTENTS

EXTERNAL VIEW.....	3
INTERNAL VIEW.....	4
DIAL CORD STRINGING.....	5
DISASSEMBLY.....	5
EXPLODED VIEW.....	6
EXPLODED VIEW PARTS LIST.....	7
CIRCUIT DESCRIPTION.....	8
ADJUSTMENT.....	14
RÉGLAGES.....	17
ABGLEICH.....	20
PC BOARD.....	24
WAVEFORMS AT CHECK POINTS.....	30
SCHEMATIC DIAGRAM.....	31
SPECIFICATIONS.....	31
PARTS LIST.....	32
SEMICONDUCTOR SUBSTITUTIONS.....	37

### Note 1

Component and circuitry are subject to modification to insure best operation under differing local conditions. This manual is based on the U.S. (K) standard, and provides information on regional circuit modification through use of alternate schematic diagrams, and information on regional component variations through use of parts list.

Region	Code
U.S.A.....	K
Canada.....	P
PX.....	U
Australia.....	X
Europe and Scandinavia.....	E
England.....	T
South Africa.....	S
Other Areas.....	M
Audio Club (KT-9177).....	H

### Note 2

Two types of T meter are used in current tuners.

Parts No. of T meter	Serial No. of tuner
B31-0291-05.....	Less than 930001
B31-0291-15.....	From 930001

These two types of T meter cannot be interchanged, because their meter circuits are different. Use the correct type of T meter when replacing.

**EXTERNAL VIEW**

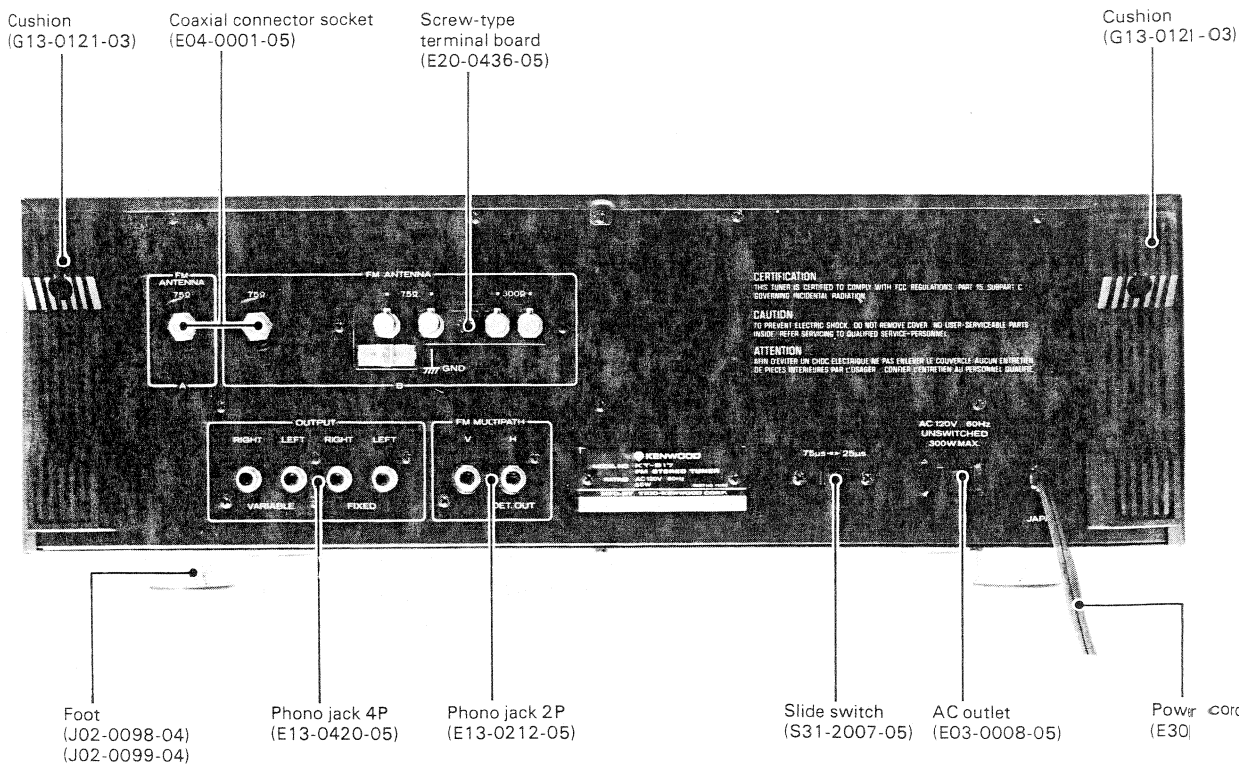
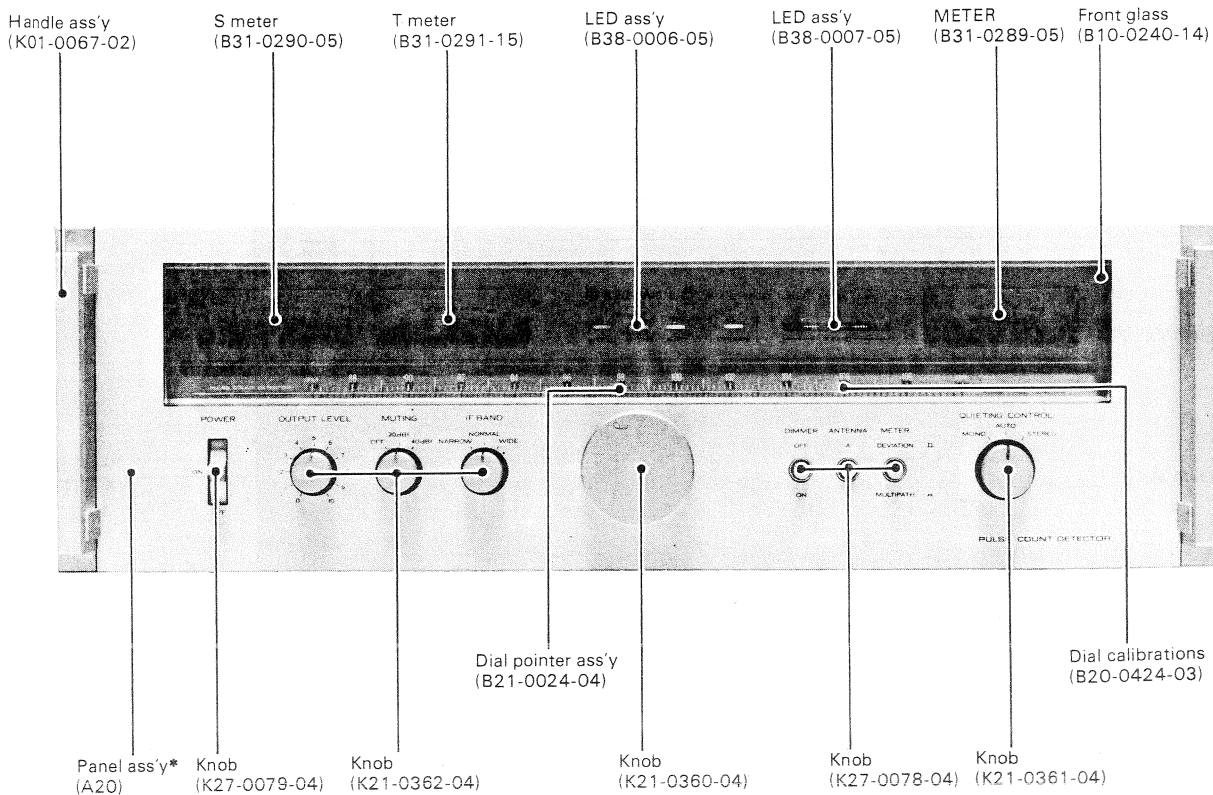

\* Refer to Parts List.

# INTERNAL VIEW

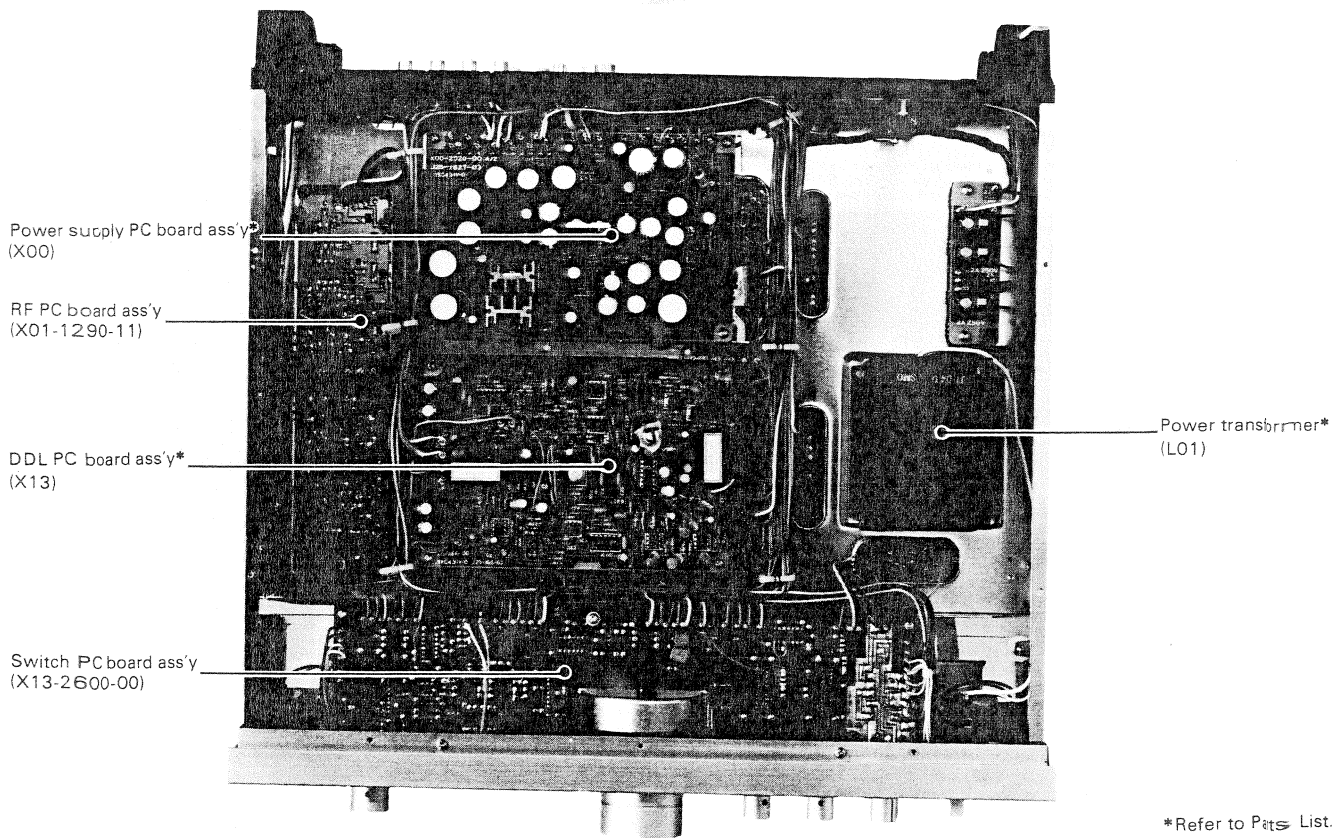
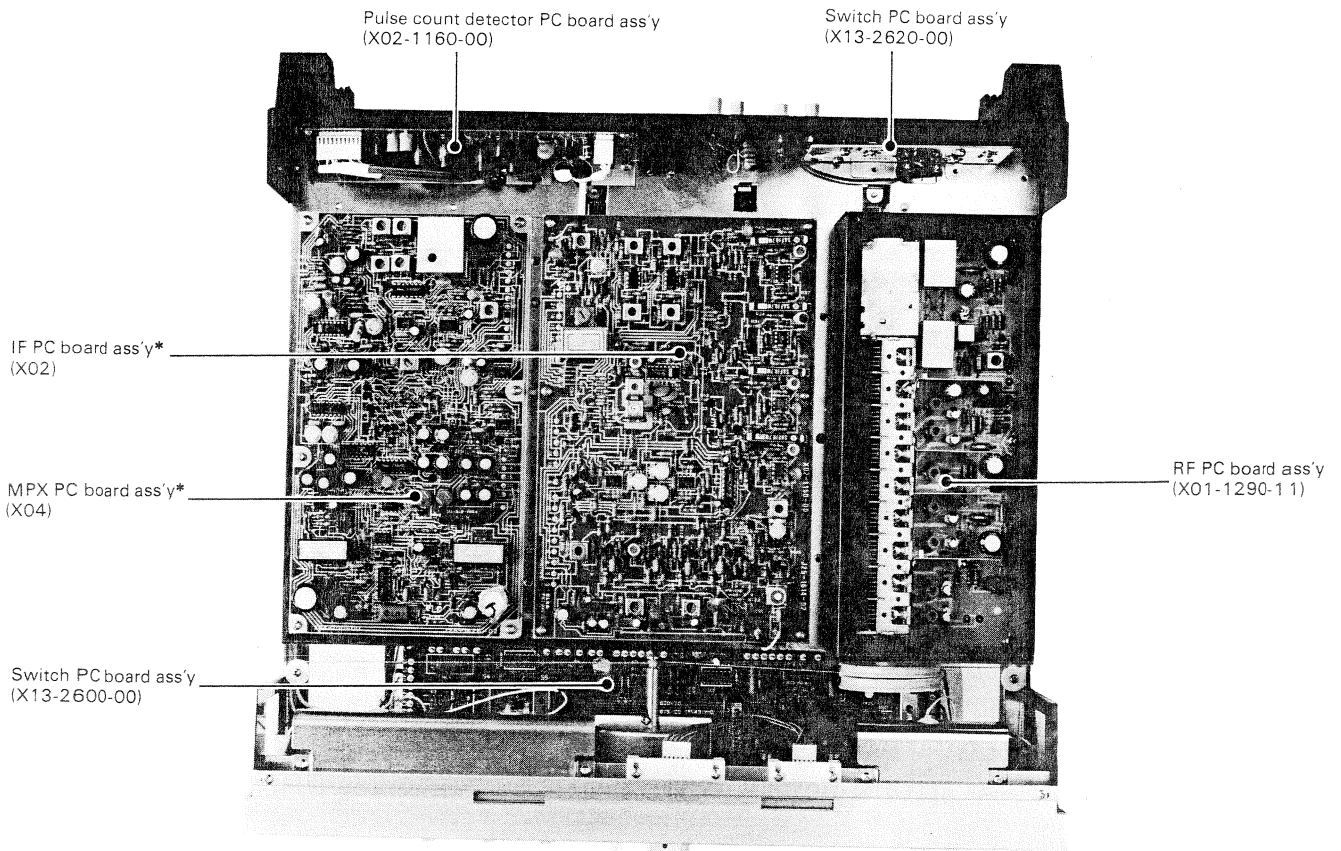

\*Refer to Parts List.



## DIAL CORD STRINGING/DISASSEMBLY

### DIAL CORD STRINGING

1. Fully open the variable capacitor.
2. Set the dial pulley as illustrated.
3. Tie the dial cord to the boss A, then dress the dial cord in the direction of "1" through "6"
4. Wind the dial cord 2 turns around the dial pulley starting from its lower side.
5. Fix the dial cord to the boss B.
6. Fully close the variable capacitor, then mount the dial pointer as illustrated.

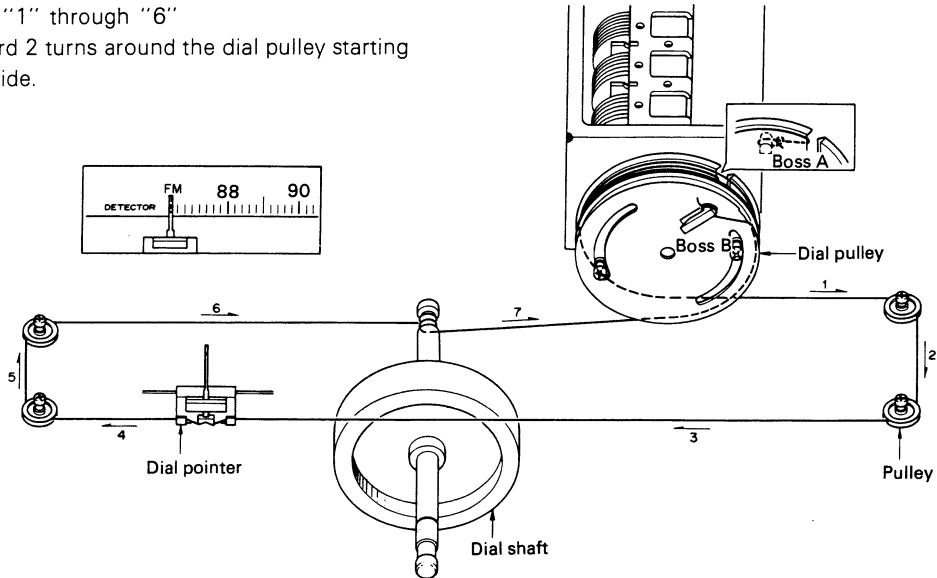

### DISASSEMBLY

#### SWITCH PC BOARD ASS'Y (X13-2620-00)

1. Remove the shield case.
2. Remove the screws fixing the rear panel to the chassis and fixing the cushions to the rear panel.
3. Decline the rear panel as illustrated.
4. Unsolder the circled sections.
5. Switch PC board ass'y can be replaced.

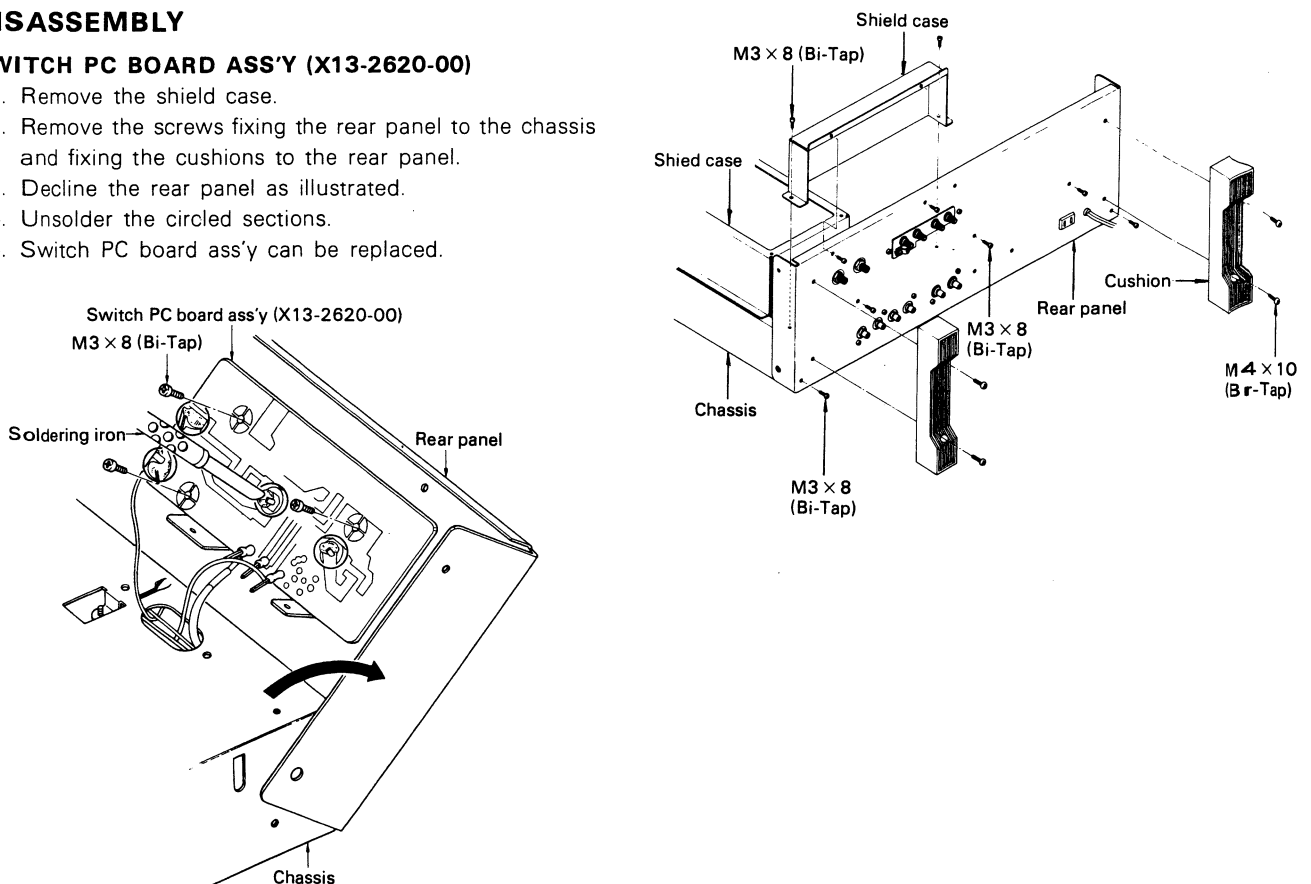

EXPLODED VIEW

A

B

1

2

3

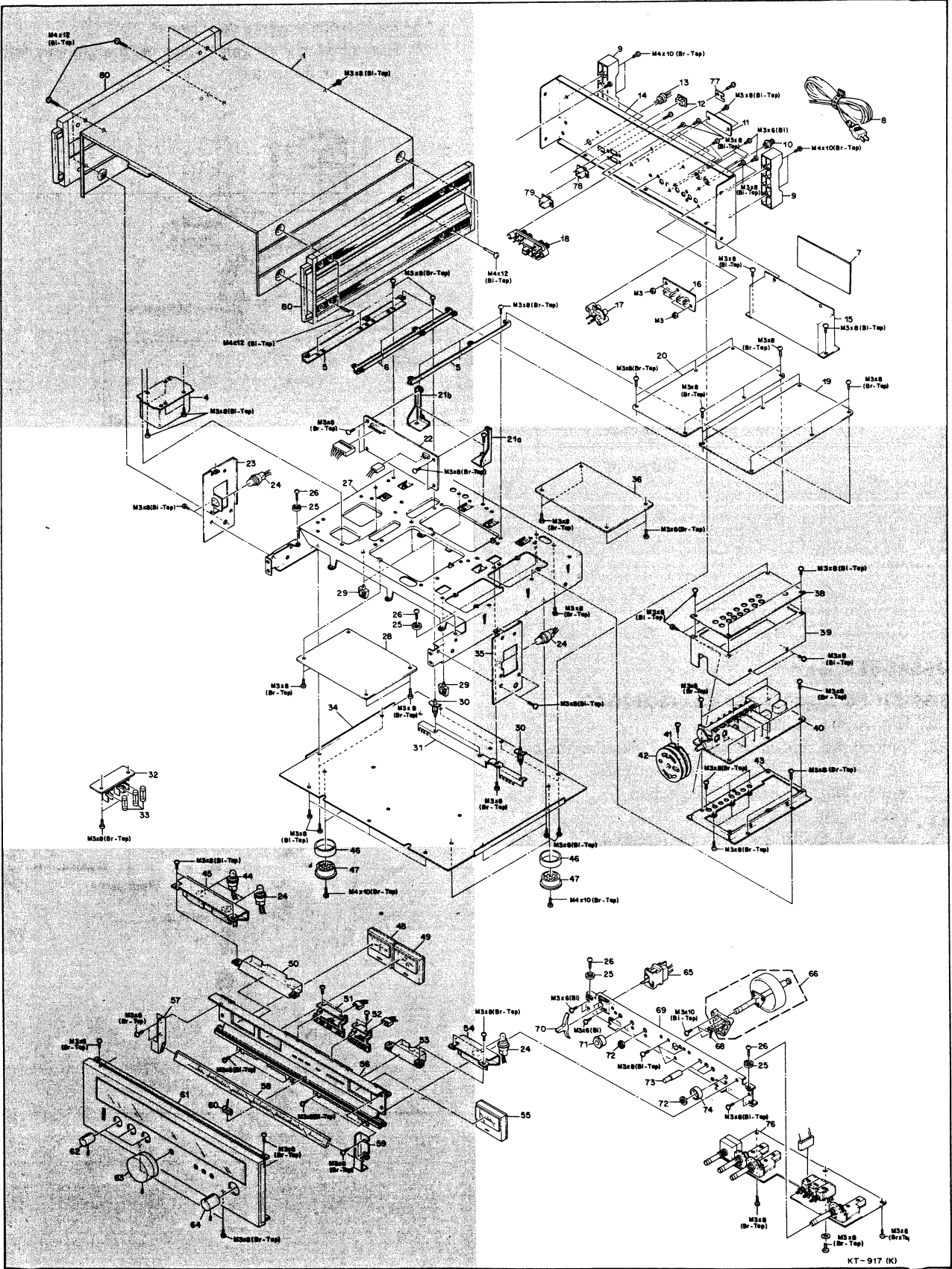

KT-917 (K)

## EXPLODED VIEW PARTS LIST

☆ : New Parts      ★ : Refer to Parts List

Fig. No.	Parts No.	Description	Re- marks
1	A01-0347-02	Case	☆ 1A
2	—	—	—
3	—	—	—
4	★	Power transformer	☆ 1A
5	—	Frame (A)	1A
6	—	Frame (B)	1A
7	X13-2620-00	Switch PC board ass'y	☆ 1B
8	★	Power cord	1B
9	G13-0121-03	Cushion	1B
10	E04-0001-05	Coaxial connector socket	1B
11	—	Model name plate	1B
12	E03-0008-05	AC outlet	1B
13	★	Power cord bushing	1B
14	—	Rear panel	1B
15	—	Shield case	1B
16	E13-0420-05	Phono jack 4P	☆ 1B
17	E13-0212-05	Phono jack 2P	☆ 1B
18	E20-0436-05	Screw-type terminal board	☆ 1B
19	★	IF PC board ass'y	☆ 1B
20	★	MPX PC board ass'y	☆ 1B
21a	—	PC board holder (A)	2B
21b	—	PC board holder (B)	1A
22	X02-1160-00	Pulse count detector PC board ass'y	☆ 2A
23	—	Meter holder (L)	2A
24	B30-0161-05	Lamp (200 mm) × 4	☆ 3A
25	D15-0170-14	Pulley	2A
26	N09-0293-05	Screw for pulley	2A
27	—	Chassis	2A
28	★	DDL PC board ass'y	☆ 2A
29	J61-0023-05	Wire clamp	2A
30	—	PC board ass'y supporter	2A
31	E29-0103-04	Lead plate	☆ 2A
32	★	Power supply PC board ass'y	☆ 2A
33	★	Fuse (X00-2020)	2A
34	★	Bottom plate	2A
35	—	Meter holder (R)	2B
36	★	Power supply PC board ass'y	☆ 2B
37	—	—	—
38	—	Shield cover	2B
39	—	Shield case	2B
40	X01-1290-11	RF PC board ass'y	☆ 2B
41	D15-0155-13	Dial pulley (A)	2B
42	D15-0156-13	Dial pulley (B)	2B
43	—	Sub chassis	2B
44	B30-0162-05	Lamp (300 mm)	☆ 3A
45	—	Meter holder	3A
46	J02-0098-04	Foot	☆ 3A 3B
47	J02-0099-04	Foot	☆ 3A 3B
48	B31-0290-05	S meter	☆ 3A
49	B31-0291-15	T meter	☆ 3A
50	B19-0202-03	Lighting plate	☆ 3A
51	B38-0006-05	LED ass'y	☆ 3A
52	B38-0007-05	LED ass'y	☆ 3A
53	B19-0195-04	Lighting plate	☆ 3A
54	—	Meter holder	3B
55	B31-0289-05	Meter	☆ 3B
56	—	Dial back board ass'y	3A
57	—	Dial calibrations holder(L)	3A

Fig. No.	Parts No.	Description	Re- marks
58	B20-0424-03	Dial calibrations	☆ 3A
59	—	Dial calibrations holder(R)	3A
60	B21-0024-04	Dial pointer ass'y	☆ 3A
61	★	Panel ass'y	☆ 3A
62	K21-0362-04	Knob	☆ 3A
63	K21-0360-04	Knob	☆ 3A
64	K21-0361-04	Knob	☆ 3A
65	★	Lever switch	☆ 3B
66	D20-0143-03	Dial shaft ass'y	☆ 3A
67	—	—	—
68	—	Wrapping terminal	3B
69	—	Sub panel	3B
70	K27-0079-04	Knob	☆ 3B
71	—	Hexagonal boss	3B
72	N10-2030-46	Hexagonal nut	3B
73	K27-0078-04	Knob	☆ 3B
74	—	Boss	3B
75	—	—	—
76	X13-2600-00	Switch PC board ass'y	☆ 3B
77	D32-0075-04	Switch stopper	1B
78	S31-2007-05	Slide switch	1B
79	S31-2050-05	Slide switch	1B
80	K01-0067-02	Handle ass'y	1A

Fig. No.	Parts No.
M3 × 8 (Br-Tap)	N87-3008-41
M4 × 10 (Br-Tap)	N87-4010-45
M3 × 8 (Bi-Tap)	N89-3008-45
M3 × 10 (Bi-Tap)	N89-3010-45
M3 × 6 (Bi)	N35-3006-45
M3 × 8 (Bi)	N35-3008-45
M4 × 12 (Bi-Tap)	N89-4012-45

## CIRCUIT DESCRIPTION

### FRONT END

#### a) RF amplifier

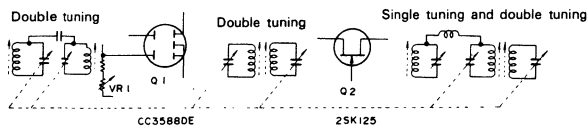

Fig. 1

The RF amplifier section has a wide-gap, 9-gang variable capacitor for the double-double-triple tuning system (one tuning stage for ANT, and two tuning stages for RF). The CC3588DE used as Q1 is a DD-MOS FET (selected SD-306) which features low noise and superior square response over a broad input level/frequency range. It also features a high power gain. VR1 adjusts Q1's input response to its maximum linearity. For servicing, adjust VR1 so that the maximum deflection of the S-meter can be obtained.

In the second stage, another double-tuning circuit is coupled to a common-gate amplifier, which features a lower input impedance and stable amplification with no influence from feedback admittance ( $y_r$ ).

Junction FET 2SK125 (Q2) has superior square response and minimum distortion characteristic.

#### b) Mixer and other related circuit

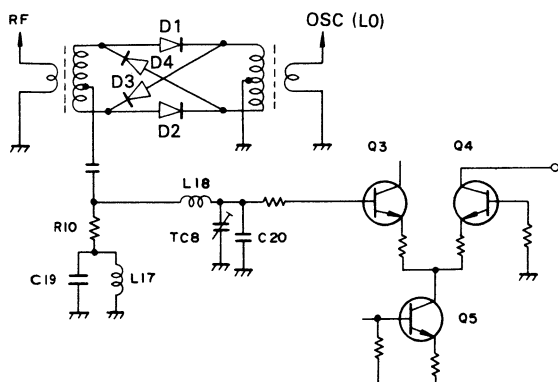

Fig. 2

Diodes D1 through D4 constitutes a double-balanced mixer. The local oscillator and the diode bridge act as a switch which alternately reverses the connection of the RF input signal to the output circuit on each half cycle of the LO. The resulting output spectrum will have suppressed even harmonics of the RF and LO.

The RF signal is converted in this mixer into the IF signal of 10.7 MHz. Transistors Q3 through Q5, a differential amplifier with a current source, constitutes an IF amplifier.

#### c) Local oscillator

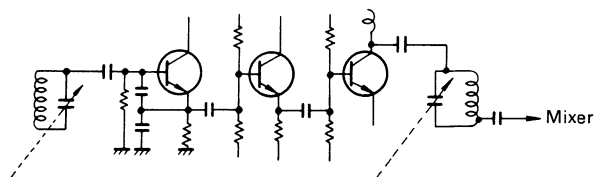

Fig. 3

As conventionally, the local oscillator uses a variable capacitor of which rotation angle is precisely corresponded with the dial calibrations. The block-construction, three-dimensional wiring in the local oscillator drastically suppresses frequency drift due to temperature or humidity variations.

The buffer amplifier and tuned buffer amplifier provided for the local oscillator supply local-oscillation signal stably and efficiently to the mixer and suppress harmonic generation.

#### d) Power supply

A powerful power supply comprised of IC1 and Q7 is provided exclusively for the front-end section since it has a variable capacitance diode D1 for DDL purpose.

## CIRCUIT DESCRIPTION

### IF SECTION

#### (1) 1st IF Amplifier (10.7 MHz)

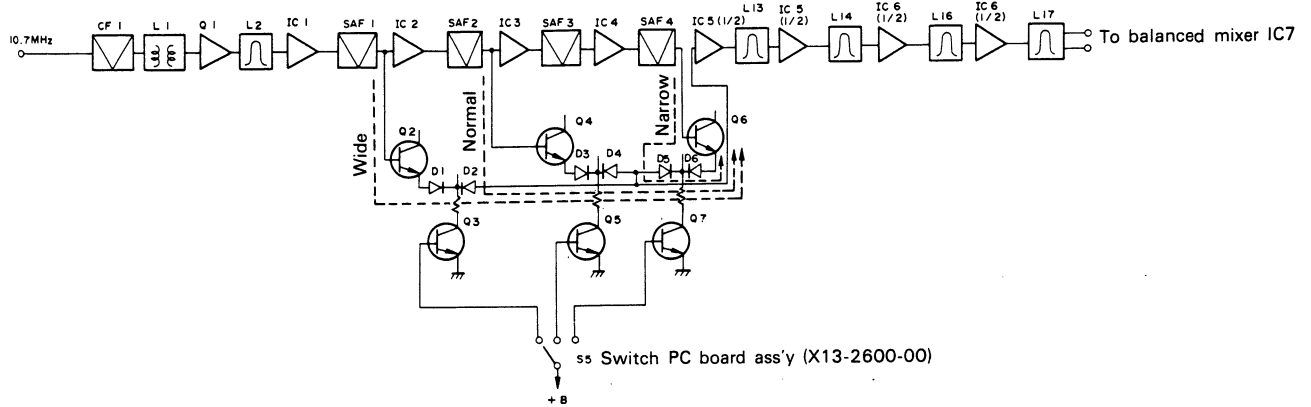

Fig. 4

For the best possible FM-reception performance under every possible reception circumstance, the IF passband width is selectable from narrow, normal, and wide. The circuits from the input through SAF1 and from IC5 through output are common to each three passband-width. The passband-width switching circuit consists of transistors and diodes.

#### Passband-width selection:

For passband-width selection, switch S5 in the switch PC board ass'y (X13-2600-00) selects the base to which a +B voltage is applied among Q3, Q5 and Q7 according to the passband-width to be selected. In the "wide" mode, for instance, the +B voltage is applied to Q3's base. This causes Q3 to turn ON, bringing the potential at the connection of D1 and D2 into almost ground level, and turning these diodes ON. As a result, the IF signal is coupled to IC5 via emitter follower Q2. The same token can be applied to the cases of "narrow" and "normal".

#### (2) Frequency Converter IC7 and Q11

##### a) Local oscillator Q11

Local oscillator Q11 is, like that in the front-end section, comprised of a Colpitts circuit which has a higher frequency stability compared with the collector-tuning type. The oscillation frequency is about 8.74 MHz.

##### b) Balanced mixer IC7

The 1st IF signal is coupled to pins 7 and 8 of IC7, and the local oscillator output is coupled to pin 4 of IC7. The sum and difference of the 1st IF signal and local oscillator output is available on pin 6 of IC7 which is a multiplier. Only the difference signal of 1.96 MHz goes through band-pass filters FL1 and FL2 before coupled to the IF sections output.



## CIRCUIT DESCRIPTION

### (3) S-meter Circuit

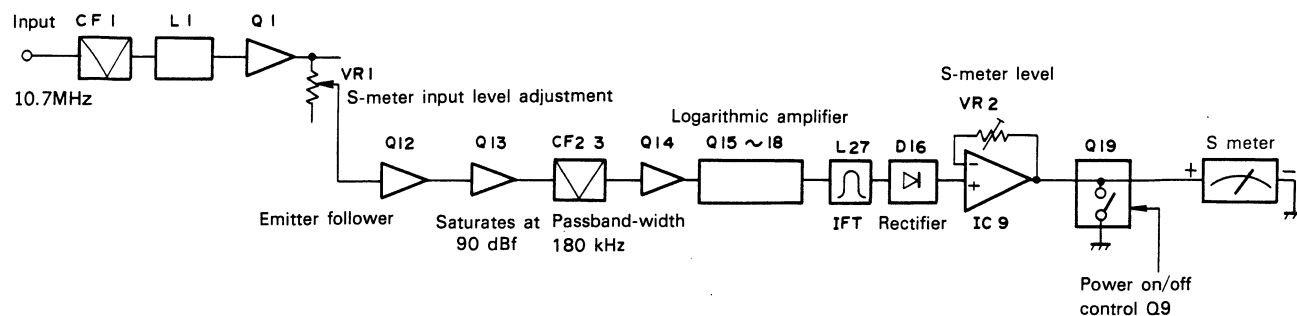

Fig. 5

The IF signal to deflect the S-meter is obtained from Q1 output via VR1. Q19 constitutes a S-meter shorting circuit which shorts out the S-meter signal immediately after the power is turned ON, bringing Q9 into OFF and Q19 into ON. When the steady state is established after the power is turned ON, Q9 turns ON, causing Q19 to turn OFF, allowing the S-meter signal to be supplied to the S-meter.

### (4) Multipath Meter Circuit

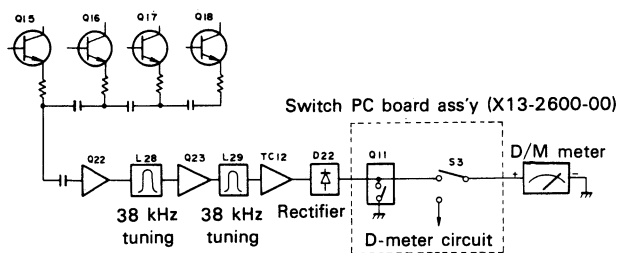
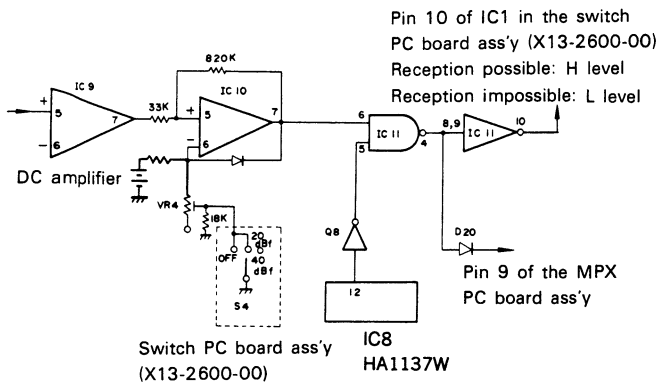

Fig. 6

The multipath-meter signal is obtained on the emitters of logarithmic amplifier Q15 through Q18. The AM component contained in the sub-carrier is detected to deflect the multipath meter after the sub-carrier (38 kHz) is tuned in with L28 and L29. Q11 shorts out the multipath-meter signal immediately after the power is turned ON, and then Q11 turns OFF to supply the multipath-meter signal to the D/M meter after the circuit is stabilized.

**CIRCUIT DESCRIPTION**

**(5) Broadcast Muting**



**Fig. 8**

The broadcast muting circuit performs broadcast-signal level and tuning detections, and if the signal level of a specific broadcast is above the muting threshold level, pin 10 of IC11 is set to "H".

IC10 constitutes a Schmitt trigger circuit of which threshold level is adjustable with VR4. When the voltage on pin 5 of this IC is higher than that on pin 6, pin 7 is set to "H", and in the reverse case, pin 7 is set to "L".

The voltage on pin 6 of IC10 is 2.8V (reference value) when S4 is set to 0 or 20 dBf position, and is 5.1V (reference value) when S4 is set to the 40 dBf position.

The rectified output for the S-meter is amplified by IC9 and coupled to pin 5 of IC10. If the signal level is more than 40 dBf, for instance, the output on pin 7 is set to "H" (reference value: 13V) since the input on pin 5 is set to 5.1V. When S4 is set to the 40 dBf position and the input level is less than 40 dBf, then the output on pin 7 is set to "L" (reference value: 0.6V).

Pin 12 of IC HA1137W generates a positive voltage when off tuned. (Refer to Fig. 9)

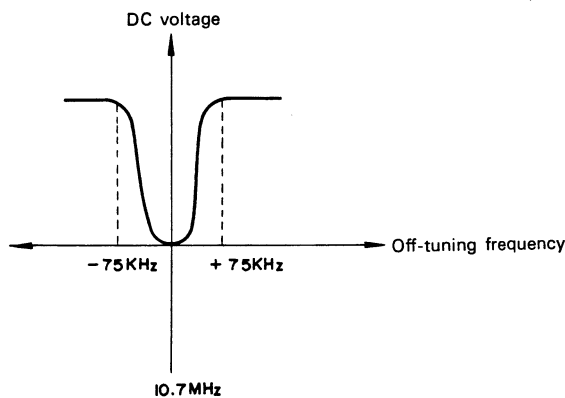
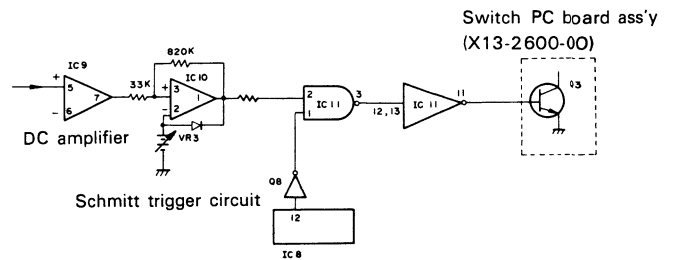

**Fig. 9**

This causes the output of inverter Q8 to go "L". The output of IC11, being a NAND gate, goes "L" only when the both inputs are set to "H", thus bringing pin 10 of IC11 into "H".

Diode D20 couples a forced mono signal to the MPX section. In other words, when a stereo broadcast is too weak and noisy, pin 4 of IC11 goes "H", causing D20 to turn ON. Q13 in the MPX section accepts an "H" level via D20 and turns ON for forced mono operation.

**(6) DDL Muting**



**Fig. 10**

The circuit operation of the DDL muting is identical to that of the broadcast muting circuit, except that the input signal level on pin 3 of IC10 at which pin 1 of IC10 goes "H" is set to more than 35 dBf. In this case, the DC voltage is around 3.2V (reference value). In other words, when the input signal level is more than 35 dBf in the tuned state, then the output of IC11 goes "H". Q3 controls DDL operation by controlling IC3 in the switch PC board ass'y (X13-2600-00).

**(7) CDS Output Circuit (Quieting Control)**

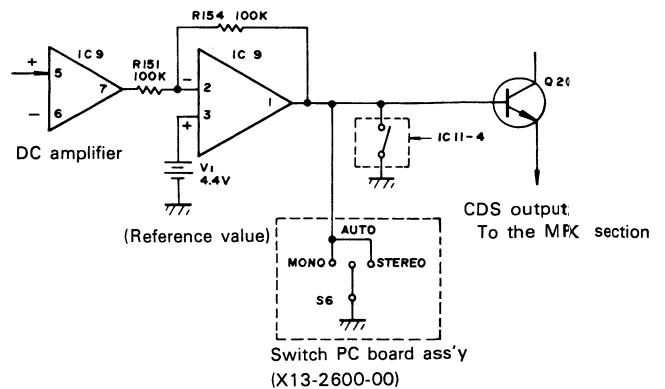

**Fig. 11**

## CIRCUIT DESCRIPTION

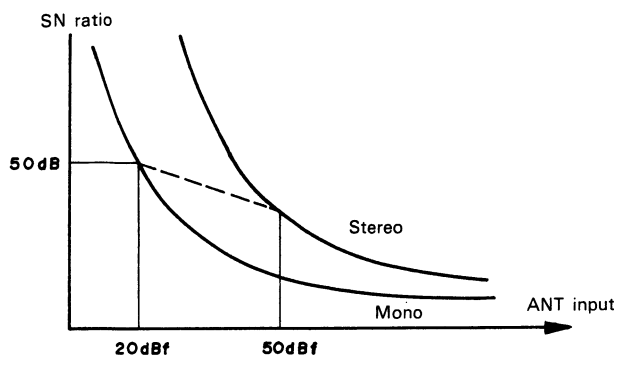

Fig. 12

As known from Fig. 12, the SN ratio of a stereo broadcast is degraded as the antenna input level is reduced. In the case of mono broadcasts, the degradation of SN ratio is not so remarkable as that of stereo broadcasts. The quieting control circuit adopted in the KT-917 blends the L-channel signal with the R-channel signal when the antenna input is less than 50 dBf. The blending ratio is controlled by the CDS in the MPX section according to the input levels.

As a result, an SN ratio profile as shown by the broken line in Fig. 12 is obtained. When the antenna input is less than 20 dBf, the stereo broadcast is blended completely into a mono signal. A better SN ratio is thus obtained with a lower input level by sacrificing to some extent separation. The CDS is controlled by the rectifier output for S-meter coming from IC9. The voltage difference of pin 3 and pin 2 of IC9, an inverting amplifier, is inverted and obtained on its output.

As known from Fig. 13, when antenna input level is more than 50 dBf, the output of IC9 is near zero volt; and when the input level is between 50 dBf and 20 dBf, the output changes on the curve shown in the same figure; and when the input level is less than 20 dBf, the output saturates. This output of IC9 controls the CDS (with variable resistance) in the MPX section via emitter follower Q20.

S6 shorts out the base of Q20 to the ground except for the AUTO mode to make the quieting control circuit operation ineffective. The output from IC11 goes "H" so as to short out the base of Q20 to the ground when the broadcast is too weak and noisy, though it does not affect, as mentioned previously, the circuit when the broadcast signal is strong enough.

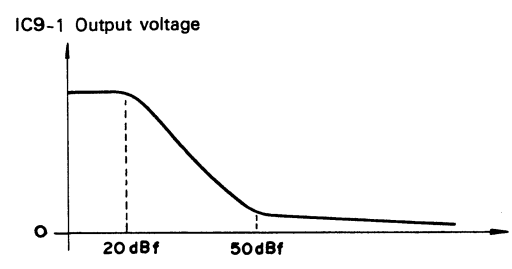

Fig. 13

### DDL (DISTORTION DETECTED LOOP)

The frequency locking and holding mechanism provided in the FM tuners on the market is roughly divided into two different types. One is to obtain a specified intermediate frequency by, like synthesizer, fixing the local oscillation frequency in the front end to 100 kHz, 50 kHz, or 25 kHz interval and mixing it with the input signal frequencies. The other is to control the local oscillation frequency so that the intermediate frequency agrees with the zero point on detector's S-curve. The former uses a crystal oscillator for local oscillation, and provides an extremely stable and accurate IF signal compared with the IC oscillator, but the intermediate frequency does not necessarily agree with that providing minimum distortion. In the latter, the intermediate frequency held at the zero point on the S-curve does not necessarily agree with the frequency that gives the minimum distortion. This is because the object of detection is not distortion itself but frequency in the both cases. The DDL system adopted for the first time in the KT-917 detects distortion itself, and controls intermediate frequency so that the distortion level detected is minimized.

Distortion generated in an FM tuner consists of two different types - one caused by the non-linearity existing in the AF circuits after detection, the other caused by a disturbance generated when the FM signal passes through a certain system. The latter, unique to the tuner and not existing in amplifiers, is caused chiefly from IF filters in the IF stage, and becomes larger as IF sensitivity increases. It is not too much saying that distortion characteristic of an FM tuner depends in most part on the distortion generated from the IF filters. The distortion generated in IF filters has a phase difference of 90 degrees depending on filter's amplitude and phase responses. Also there are factors which cause the 2nd, 3rd, and higher harmonic distortions independently from the amplitude and phase responses. At no intermediate frequency all these distortion become zero at the same time, but it is possible to reduce the most principal factor among them to nearly zero.

When looking at a tuner's detuning response, it is known that distortion variation vs. detuning frequency is most remarkable when only the L or only the R channel is modulated. Therefore, the minimum distortion is obtained if an intermediate frequency is selected at which the IF filter's distortion factor depending on the detuning response in the only the L or only the R modulation mode is made zero.

The distortion depending on the detuning response in the only the L or only the R modulation mode results from the amplitude characteristics of the IF filter and mostly consists of the 2nd harmonic. Therefore, the distortion factor resulted from the amplitude characteristics can be detected by using a SAF filter, which has a linear phase response, i.e., a flat GDT response, or an equivalent ceramic filter, because such a filter cause little phase distortion resulted from the phase characteristics.

## CIRCUIT DESCRIPTION

In the KT-917, the intermediate frequency providing the minimum distortion is obtained as follows. When the received signal is converted into the IF signal, the received signal is modulated by a higher frequency signal. The 2nd harmonic distortion generated when the modulated signal passes through the IF filter is detected after FM detection. The detected distortion signal is converted into a DC voltage, which is applied to the local oscillator and controls the local oscillation frequency, finally controls the intermediate frequency so that the detected DC voltage keeps 0 volt. Thus, the intermediate frequency providing the minimum distortion is obtained.

### S/H MPX (SAMPLE AND HOLD MPX)

#### (1) Theory

To demodulate stereo broadcast signals having a pilot tone into L and R channel signals, a demodulation system is used in which the composite signal is regarded as a time-division signal so as to create a signal with the same frequency as and synchronized with the subcarrier of 38 kHz, and the composite signal is switched with the created signal.

A 38 kHz signal generated by the PLL circuit and synchronized with the input pilot signal is used in most cases for the switching signal, and is mostly a square wave with its duty cycle of 50.

The separation obtained with this square-wave signal is, however, at best about 13 dB if a circuit which cancels out the crosstalk component is not used. To improve this separation by using a simple switching circuit, the ON time of the switching circuit is to be reduced.

However, this method too, in which the mean value by the subcarrier is used as the switching output, has an inherent limit with respect to separation. In this respect, therefore, a switching circuit using the sample and hold system, in which the subcarrier's peak point is sampled and held, is so far the best advantageous approach.

When looking at the composite signal waveform, it is known that the information included in the peak point of the subcarrier contains that of either the left or right channel only. In other words, the separation at the peak point is infinite.

#### (2) Actual Circuit Configuration

To capture the subcarrier's peak point without fail, relative timing between the switching signal and subcarrier is the most important factor. For this purpose, a 38 kHz switching signal completely in-phase with the composite signal is created by PLL ICs. The signal is a square wave with its duty of 50. Therefore, it is shaped into a pulse signal with a smaller duty ratio and steeper leading and trailing edges. The trailing edge of the signal is timed with the subcarrier peak. To do this, the phase of the 19 kHz pilot signal to be coupled to the PLL circuit must be shifted in advance. The subcarrier peak can thus be detected by the above procedure.

The peak voltage is then held by a capacitor until another different peak voltage is applied across the capacitor.

To hold the peak voltage across the capacitor without any error, the circuit must have a capability of following up short sampling intervals. For this purpose, a push-pull emitter follower is adopted for lower-impedance signal source, and complementary FETs are used for the switching device for a lower ON resistance.

In order to prevent the charged voltage from discharging in the OFF state of the switch, the switch has a high OFF resistance, and in addition, the Bi FET operational amplifier is used in the next stage for a very high load impedance viewed from the switch.

The S/H MPX is advantageous not only for better separation but for better tonal quality since a simpler low-pass filter can be adopted for subcarrier elimination because of much lower subcarrier leak generated during modulation compared with conventional switching circuits. In the current measuring method, the subcarrier leak is measured during modulation. However, this subcarrier leak in conventional switching circuits is much more increased during modulation. In contrast, the S/H MPX circuit has less amplitude variation of the 38 kHz component after demodulation, and hence has a higher dynamic subcarrier-suppression ratio.

## ADJUSTMENT

Set the MUTING switch to OFF, MODE switch STEREO and IF BAND switch NORMAL, unless otherwise specified.

NO.	ALIGNMENT	TEST EQUIPMENTS		TUNER SETTING	OUTPUT INDICATOR	ADJUSTMENT POINTS	REMARKS
		CONNECTION	SETTING				
1	T METER (1)	Ⓐ*1	95 MHz 1 kHz, 75 kHz Dev	95 MHz	Ⓑ	—	*2
2	T METER (2)	ditto	95 MHz 1 kHz, 75 kHz Dev 60 dB*3	95 MHz Touch the tuning knob by hand.	T meter	X02-1150 L22	T meter pointer to be on the center line
3	DISTORTION	ditto	ditto	95 MHz	Distortion meter to pin 6 of IC8	X01-1150 L23	Minimum distortion
Repeat alignment "2. T METER (2)".							
4	TRACKING (1)	Ⓐ	90 MHz 1 kHz, 75 kHz Dev	90 MHz	S meter	X01-1290 L7, 6, 5, 4, 3	Maximum deflection
5	TRACKING (2)	ditto	ditto	ditto	Ⓑ	X01-1290 L2, 1	Minimum distortion and maximum output
6	TRACKING (3)	ditto	106 MHz 1 kHz, 75 kHz Dev	106 MHz	S meter	X01-1290 TC7, 6, 5, 4, 3	Maximum deflection
7	TRACKING (4)	ditto	ditto	ditto	Ⓑ	X01-1290 TC2, 1	Minimum distortion and maximum output
8	RF	ditto	95 MHz 1 kHz, 75 kHz Dev 40 dB*3	95 MHz	S meter	X01-1290 VR1, TC8	Maximum deflection
9	DDL (1)	ditto	95 MHz 1 kHz, 75 kHz Dev 60 dB*3	ditto	Frequency counter across R101 via SSV*4	X13-2610 VR2	96 kHz
10	DDL (2)	ditto	ditto	ditto	*5	X13-2610 VR1	*6
11	DDL (3) (OFFSET)	ditto	ditto	ditto	*7	X13-2610 VR3	0V
12	MPX-VCO	ditto	ditto	ditto	*8	X04-1110 VR2	76 kHz
13	S METER (1)	ditto	95 MHz 1 kHz, 75 kHz Dev 40 dB*	ditto	S meter	X02-1150 L27	Maximum deflection
14	S METER (2)	ditto	95 MHz 0 Dev 68.8 dB*	ditto	ditto	X02-1150 VR2	S meter indicates 80 dBf.
15	S METER (3)	ditto	95 MHz 0 dev 8.8 dB*3	ditto	ditto	X02-1150 VR1	S meter indicates 20 dBf.
Repeat alignments "14. S METER (2) and 15. S METER (3)" several times.							
16	DDL MUTING	Ⓐ	95 MHz 0 Dev 35 dBf (S meter's indication)	95 MHz	LED for DDL	X02-1150 VR3	*10
17	MUTING	ditto	95 MHz 1 kHz, 75 kHz Dev *11	ditto	Ⓑ	X02-1150 VR4	*12



## ADJUSTMENT

NO.	ALIGNMENT	TEST EQUIPMENTS		TUNER SETTING	OUTPUT INDICATOR	ADJUSTMENT POINTS	REMARKS
		CONNECTION	SETTING				
18	SUB	Ⓒ	95 MHz 1 kHz, 68.25 kHz Dev*13 60 dB*3 SELECTOR: L-R	ditto	ditto	X04-1110 VR1, 5, 6	Maximum output Beforehand, set the VR1 to its center.
19	PILOT CANCELLER	ditto	95 MHz Pilot signal 60 dB*3	ditto	SSVM to emitter of Q15 (X04-1110)	X04-1110 VR3, L5	Minimum output
20	DISTORTION (STEREO)	ditto	95 MHz 1 kHz, 68.25 kHz Dev*13 60 dB*3 SELECTOR: L or R	95 MHz WIDE	Ⓑ	X01-1290 L8	Minimum distortion
21	SEPARATION (1)	ditto	ditto	95 MHz NARROW	ditto	X04-1110 VR9	Minimum crosstalk from the other channel
22	SEPARATION (2)	ditto	ditto	95 MHz WIDE	ditto	X04-1110 VR8	ditto
23	SEPARATION (3)	ditto	95 MHz 10 kHz, 68.25 kHz Dev*13 60 dB*3 SELECTOR: L or R	ditto	ditto	X04-1110 FL2	ditto *14
Repeat alignments "20~23" several times.							
24	SEPARATION (4)	Ⓒ	95 MHz 1 kHz, 68.25 kHz Dev*13 60 dB*3 SELECTOR: L or R	95 MHz NORMAL	Ⓑ	X13-2600 VR1	Minimum crosstalk from the other channel
25	SCA (1)	Ⓐ	95 MHz 67 kHz, 6.75 kHz Dev 60 dB* SELECTOR: L + R	ditto	DC voltmeter to anode of D4 (X04-1110)	X04-1110 L6	Maximum DC voltage
26	SCA (2)	ditto	ditto	ditto	DC voltmeter to pin 7 of IC2 (X04-1110)	X04-1110 VR4	*15
27	D METER	ditto	95 MHz 1 kHz, 75 kHz Dev 60 dB*3	95 MHz NORMAL METER DEVIATION	D meter	X04-1110 VR7	D meter indicates 100%
28	MULTIPATH METER	AG to the con- necting point of R123 and C83 (X02-1150) Short the both ends of R33.	38 kHz	95 MHz NORMAL METER: MULTIPATH	Multipath Meter	X02-1150 L28, 29	Maximum deflection

## ADJUSTMENT

### TEST INSTRUMENTS

Oscilloscope .....	OSC
FM signal generator .....	FM-SG
Audio generator .....	AG
Solid state voltmeter .....	SSVM
FM multiplex generator .....	FM-MPX
Frequency counter	
DC voltmeter	

\*1 To perform precise adjustment, a SG (with 75Ω output impedance) must be directly connected to the tuner. Use a connecting cable with a BNC connector at the SG end and an F connector at the tuner end. When an open-scaled SG (which indicates the output level when no load is connected) is used, subtract 6 dB from the SG reading to obtain ANT input level. If the output impedance of the SG is 50Ω, use a new IHF standard 50Ω: 75Ω dummy antenna.

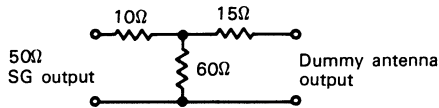

50Ω: 75Ω dummy antenna

If an open-scaled SG is used, subtract 12 dB from the SG reading to obtain ANT input level. If a load-scaled SG (which indicates the output level when a 50Ω load is connected) is used, subtract 6 dB from the SG reading.

\*2 Adjust the tuning knob so that the same amount of noise is observed at the top and bottom of the output waveform with a weak signal.

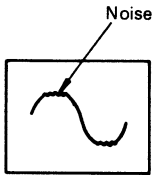

\*3 Tuner input level

\*4

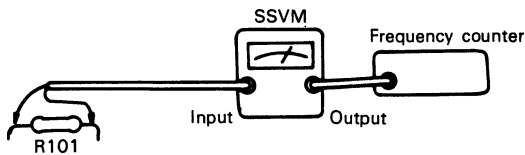

Since the output level is low, it must be amplified by a SSVM.

\*5 Connect the hot end of R101 to the Vertical input of the oscilloscope, and Pin 4 of IC13 to the Horizontal input of the oscilloscope, so that a Lissajous' figure is obtained.

Make sure to ground the connection between C17 and R111.

\*6 Lissajous' figure



\*7 Connect a DC voltmeter to Pin 1 of IC6 (X13-2610), shorting Pin 7 of IC1 and Pin 3 of IC1.

\*8 Clip the positive clip of the SSVM input cable to the body of C16 (X04-1110), and supply the SSVM output to the frequency counter.

\*9 If an open-scaled SG is directly connected to the tuner via an F connector, adjust the SG output to 74.8 dB. If impossible, adjust it to 74.5 dB.

\*10 Turn VR3 until the LED goes off, then turn it slightly in the opposite way until the LED lights up again.

\*11 Output causing the S meter to indicate 20 dBf.

\*12 Turn VR4 until the output waveform disappears, then turn it slightly in the opposite way until the output waveform appears again.

\*13 Set deviation to 68.25 kHz with selector in L + R position. Set deviation of pilot signal to 6.75 kHz (9%).

\*14 If sufficient separation cannot be obtained, turn VR5 and VR6 within ±5°. (If they are turned too much, separation at 1 kHz will deteriorate.)

\*15) Set VR4 to the position where the voltmeter reading changes from positive to negative.

## RÉGLAGES

Placer le MUTING dans la position OFF, MODE sur STÉRÉO et IF BAND sur NORMAL, sauf indiqué spécialement.

No.	ALIGNEMENT	APPAREILLAGE		RÉGLAGE DU TUNER	INDICATEUR DE SORTIE	POINTS DE RÉGLAGES	REMARQUES
		RACCORDEMENT	RÉGLAGE				
1	INDICATEUR À ZÉRO CENTRAL (1)	Ⓐ *1	95 MHz 1 kHz (Mod.) 75 kHz (Dev.)	95 MHz	Ⓑ	—	*2
2	INDICATEUR À ZÉRO CENTRAL (2)	idem	95 MHz 1 kHz (Mod.) 75 kHz (Dev.) 60 dB (ENTRÉE ANT) *3	95 MHz Toucher le bouton d'accord avec la main	INDICATEUR A ZERO CENTRAL	L22 (X02-1150)	Aiguille de l'indicateur à zéro central en position centrale
3	DISTORSION	idem	idem	95 MHz	Relier le distorsiomètre au plot 6 de IC8	L23 (X01-1150)	Distorsion minimale
Répéter le point 2 "Indicateur d'accord (2)"							
4	ALIGNEMENT (1)	Ⓐ	95 MHz 1 kHz (Mod.) 75 kHz (Dev.)	90 MHz	INDICATEUR DE CHAMP	L7,6,5,4,3 (X01-1290)	Déviati on maximale
5	ALIGNEMENT (2)	idem	idem	idem	Ⓑ	L2, 1 (X01-1290)	Distorsion minimale et déviati on maximale
6	ALIGNEMENT (3)	idem	106 MHz 1 kHz (Mod.) 75 kHz (Dev.)	106 MHz	INDICATEUR DE CHAMP	TC7,6,5,4,3 (X01-1290)	Déviati on maximale
7	ALIGNEMENT (4)	idem	idem	idem	Ⓑ	TC2, 1 (X01-1290)	Distorsion minimale et déviati on maximale
8	FR	idem	95 MHz 1 kHz (Mod.) 75 kHz (Dev.) 40 dB (ENTRÉE ANT) *3	95 MHz	INDICATEUR DE CHAMP	VR1, TC8 (X01-1290)	Déviati on maximale
9	DDL (1)	idem	95 MHz 1 kHz (Mod.) 75 kHz (Dev.) 60 dB (ENTRÉE ANT) *3	idem	Relier le compteur de fréquence à la résistance R101 par SSV M	VR2 (X13-2610)	96 kHz
10	DDL (2)	idem	idem	idem	*5	VR1 (X13-2610)	*6
11	DDL (3) (OFFSET)	idem	idem	idem	*7	VR3 (X13-2610)	0V
12	MPX. VCO	idem	idem	idem	*8	VR2 (X04-1110)	76 kHz
13	INDICATEUR DE CHAMP (1)	idem	95 MHz 1 kHz (Mod.) 75 kHz (Dev.) 40 dB (ENTRÉE ANT) *3	idem	INDICATEUR DE CHAMP	L27 (X02-1150)	Déviati on maximale
14	INDICATEUR DE CHAMP (2)	idem	95 MHz 1 kHz (Mod.) 0 (Dev.) 68,8 dB (ENTRÉE ANT)	idem	idem	VR2 (X02-1150)	80 dBf
15	INDICATEUR DE CHAMP (3)	idem	95 MHz 0 (Dev.) 8,8 dB (ENTRÉE ANT) *3	idem	idem	VR1 (X02-1150)	20 dBf

D DL-Boucle détection de distorsion.

# RÉGLAGES

N°.	ALIGNEMENT	APPAREILLAGE		RÉGLAGE DU TUNER	INDICATEUR DE SORTIE	POINTS DE RÉGLAGES	REMARQUES
		RACCORDEMENT	RÉGLAGE				
Répéter les points 14 et 15 plusieurs fois							
16	DDL MUTING	Ⓐ	95 MHz 0 (Dev) 35 dBf (Indicateur de champ)	95 MHz	LED de DDL	VR3 (X02-1150)	*10
17	MUTING	idem	95 MHz 1 kHz (Mod) 75 kHz (Dev) *11	idem	Ⓑ	VR4 (X02-1150)	*12
18	SUB	Ⓒ	95 MHz 1 kHz (Mod) 68,25 kHz (Dev)*13 60 dB (ENTRÉE ANT)*3 SELECTION (L - R)	idem	idem	VR1, 5, 6 (X04-1110)	Sortie maximale (Régler préalablement le VR1 dans la position, centrale)
19	Circuit suppression de signal pilote	idem	95 MHz signal pilote 60 dB (ENTRÉE ANT) *3	idem	Relier le SSVM à l'émetteur de Q15 (X04-1110)	VR3, L5 (X04-1110)	Sortie minimale
20	DISTORSION (STÉRÉO)	idem	95 MHz 1 kHz (Mod) 68,25 kHz (Dev)*13 60 dB (ENTRÉE ANT)*3 SELECTION (L ou R)	95 MHz (WIDE)	Ⓔ	L8 (X01-1290)	Distorsion minimale
21	SÉPARATION (1)	idem	idem	95MHz (NARROW)	idem	VR9 (X04-1110)	Diaphonie minimale
22	SÉPARATION (2)	idem	idem	95 MHz (WIDE)	idem	VR8 (X04-1110)	idem
23	SÉPARATION (3)	idem	95 MHz 10 kHz (Mod) 68,25 kHz (Dev)*13 60 dB (ENTRÉE ANT)*3 SELECTION (L ou R)	idem	idem	FL2 (X04-1110)	idem *14
Répéter les points 20 ~ 23 plusieurs fois							
24	SÉPARATION (4)	Ⓒ	95 MHz 10 kHz (Mod) 68,25 kHz (Dev)*13 60 dB (ENTRÉE ANT)*3 SELECTION (L ou R)	95 MHz NORMAL	Ⓔ	VR1 (X13-2600)	Diaphonie minimale
25	SCA (1)	Ⓐ	95 MHz 67 kHz (Mod) 6,75 kHz (Dev) 60 dB (ENTRÉE ANT)*3 SELECTION (L + R)	idem	Relier le voltmètre CC à l'anode de D 4 (X04-1110)	L6 (X04-1110)	Lecture maximale du voltmètre CC
26	SCA (2)	idem	idem	idem	Relier le voltmètre CC au plot 7 de IC2 (X04-1110)	VR4 (X04-1110)	*15
27	INDICATEUR DE DÉVIATION	idem	95 MHz 1 kHz (Mod) 75 kHz (Dev) 60 dB (ENTRÉE ANT) *3	95 MHz NORMAL MÈTRE: DÉVIATION	INDICATEUR DE DÉVIATION	VR7 (X04-1110)	100%
28	INDICATEUR DE RÉCEPTIONS MULTIPLES	Relier le générateur de fréquence audio aux point de connexion de R123 et C83 (X02-1150), court-circuitant deux extrémités de R33	38 kHz	95 MHz NORMAL MÈTRE: MULTIPATH	INDICATEUR DE MULTIPATH	L28, 29 (X02-1150)	Déviations maximale

DDL- Boucle détection de distorsion

# RÉGLAGES

## APPAREILLAGE

- Oscilloscope ..... OSC
- Générateur MA ..... AM-SG
- Générateur MF ..... MF-SG
- Générateur audio fréquences ..... AG
- Voltmètre à transistor ..... SSVM
- Générateur multiplex stéréo ..... FM-MPX
- Voltmètre CC
- Compteur de fréquence

**\*1** Pour réaliser un ajustement précis, SG (avec 75Ω d'impédance de sortie) doit être connecté directement au tuner. Utiliser un câble de connexion avec un connecteur BNC à l'extrémité de SG et un connecteur F à l'extrémité du tuner. Quand un SG à échelle ouverte (ce qui indique que le niveau de sortie au moment où il n'y a aucune charge de connectée) est utilisé, soustraire 6 dB de la lecture SG pour obtenir le niveau d'entrée ANT.

Si l'impédance de sortie de SG est de 50Ω, utiliser un antenne artificielle de 50Ω: 75Ω de la nouvelle norme IHF.

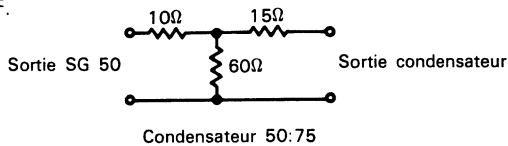

Si un SG à échelle ouverte est utilisé, soustraire 12 dB de la lecture SG pour obtenir le niveau d'entrée ANT. Si un SG à échelle chargée (ce qui indique que le niveau de sortie au moment où la charge de 50Ω est connectée) est utilisé, soustraire 6 dB de la lecture SG.

**\*2** Ajuster le bouton d'accord de façon que la même quantité du bruit puisse être observé au sommet et en bas de la forme d'onde de sortie sous des conditions d'alimentation de signal faible.

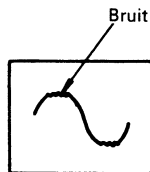

**\*3** Niveau d'entrée du tuner  
**\*4**

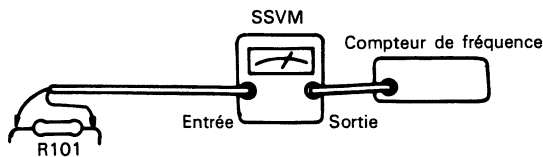

Étant donné que le niveau de sortie de l'oscillateur est bas, le signal de sortie doit être amplifié par SSVM.

- \*5** Connecter l'extrémité excitée de R101 à l'entrée verticale de l'oscilloscope, et le plot 4 de IC13 à l'entrée horizontale de l'oscilloscope, de façon à obtenir la figure de Lissajous. S'assurer de bien mettre à la masse la connexion entre C17 et R111.
- \*6** Figure de Lissajou



- \*7** Connecter un voltmètre à CC au plot 1 de IC6 (X13-2610), en court-circuitant le plot 7 de IC1 avec le plot 3 de IC1.
- \*8** Pincer l'armature de C16 (X04-1110) avec la pince positive du câble d'entrée SSVM, et appliquer la sortie SSVM au compteur de fréquence.
- \*9** Si un SG à échelle ouverte est connecté directement au tuner par l'intermédiaire du connecteur F, ajuster la sortie SG à 74,8 dB. Si cela s'avère impossible, ajuster la valeur à 74,5 dB.
- \*10** Tourner VR3 jusqu'à ce que la diode lumineuse s'éteigne, ensuite le tourner légèrement dans le sens opposé jusqu'à ce que la diode lumineuse s'allume à nouveau.
- \*11** Sortie provoquant l'indication 20 dBf à l'indicateur S.
- \*12** Tourner VR4 jusqu'à ce que la forme d'onde de sortie disparaisse, le tourner ensuite légèrement dans le sens opposé jusqu'à ce que la forme d'onde de sortie apparaisse à nouveau.
- \*13** Régler la déviation à 68,25 kHz avec le sélecteur à la position L+R (G+D). Régler la déviation du signal pilote à 6,75 kHz (6%).
- \*14** Si l'on ne peut obtenir une séparation suffisante, tourner VR5 et VR6 dans les limites de ±5°. Si l'on tourne de trop, la séparation à 1 kHz sera dépassée).
- \*15** Régler VR4 à la position à laquelle la lecture du voltmètre passe de positive à négative.



## ABGLEICH

Außer wenn anders angegeben, MUTING-Schalter auf OFF, MODE-Schalter auf Stereo und IF-BAND-Schalter auf NORMAL einstellen.

NR.	ABGLEICH	PRÜFEINRICHTUNG		TUNER EINSTELLUNG	AUSGANGS-ANZEIGE	EINSTELL-PUNKT	BEMERKUNGEN
		ANSCHLÜSSE	EINSTELLUNG				
1	KANALMITTEN-ANZEIGER (1)	Ⓐ *1	95 MHz 1 kHz, 75 kHz Hub	95 MHz	Ⓑ	—	*2
2	KANALMITTEN-ANZEIGER (2)	dito	95 MHz 1 kHz, 75 kHz Hub 60 dB*3	95 MHz Einstellknopf mit der Hand berühren	Kanalmitten- Anzeiger	X02-1150 L22	Nadel des Kanal- mitten-Anzeigers muß auf Mittellinie stehen
3	KLIRRFAKTOR	dito	dito	95 MHz	Klirrfactormes- ser zu Kle- mme 6 von IC8	X02-1150 L23	Minimaler Klirr
Abstimmung „2 KANALMITTEN-ANZEIGER (2)“ neu einstellen.							
4	EMPFANGS- BEREICH (1)	Ⓐ	90 MHz 1 kHz, 75 kHz Hub	90 MHz	Feldstärkein- strument	X01-1290 L7,6,5,4,3	Maximaler Ausschlag
5	EMPFANGS- BEREICH (2)	dito	dito	dito	Ⓑ	X01-1290 L2, 1	Minimaler Klirr und maximaler Ausgang
6	EMPFANGS- BEREICH (3)	dito	106 MHz 1 kHz, 75 kHz Hub	106 MHz	Feldstärkein- strument	X01-1290 TC7,6,5,4,3	Maximaler Ausschlag
7	EMPFANGS- BEREICH (4)	dito	dito	dito	Ⓑ	X01-1290 TC2, 1	Minimaler Klirr und maximaler Ausgang
8	RF	dito	95 MHz 1 kHz, 75 kHz Hub 40 dB*3	95 MHz	Feldstärkein- strument	X01-1290 VR1, TC8	Maximaler Ausschlag
9	DDL (1)	dito	95 MHz 1 kHz, 75 kHz Hub 60 dB*3	dito	Frequenzzähler über R101 via SSVM	X13-2610 VR2	96 kHz
10	DDL (2)	dito	dito	dito	*5	X13-2610 VR1	*6
11	DDL (3) (OFFSET)	dito	dito	dito	*7	X13-2610 VR3	0V
12	MPX-VCO	dito	dito	dito	*8	X04-1110 VR2	76 kHz
13	FELDSTÄRKEIN- STRUMENT (1)	dito	95 MHz 1 kHz, 75 kHz Hub 40 dB*3	dito	Feldstärkein- strument	L27	Frequenzzähler über R101 via SSVM
14	FELDSTÄRKEIN- STRUMENT (2)	dito	95 MHz 0 Hub 68,8 dB*9	dito	dito	X02-1150 VR2	Feldstärkein- strument gibt dBf an
15	FELDSTÄRKEIN- STRUMENT (3)	dito	95 MHz 0 Hub 8,8 dB*3	dito	dito	X02-1150 VR1	Feldstärke- instrument gibt 20 dBf an
Abstimmungen 14 Feldstärkeinstrument (2) und 15 Feldstärkeinstrument (3) mehrere Male wiederholen.							
16	DDL MUTING	Ⓐ	95 MHz 0 Hub 35 dBf (Anzeige von Feldstärkeinstrument)	95 MHz	LED für DDL	X02-1150 VR3	*10
17	MUTING	dito	95 MHz 1 kHz, 75 kHz Hub *11	dito	Ⓑ	X02-1150 VR4	*12

**ABGLEICH**

NR.	ABGLEICH	PRÜFEINRICHTUNG		TUNER EINSTELLUNG	AUSGANGS- ANZEIGE	EINSTELL- PUNKT	BEMERKUNGEN
		ANSCHLÜSSE	EINSTELLUNG				
18	SUB	Ⓒ	95 MHz 1 kHz, 68,25 kHz Hub *13 60 dB*3 SELECTOR: L-R	dito	dito	X04-1110 VR1,5,6	Maximaler Aus- gang, VR1 muß in Mittelstel- lung sein
19	PILOT- LÖSCHER	dito	95 MHz Pilotsignal 60 dB*3	dito	SSVM zu Emitter von Q15 (X04-1110)	X04-1110 VR3, L5	Minimaler Ausgang
20	KLIRRFAKTOR (STEREO)	dito	95 MHz 1 kHz, 68,25 kHz Hub*13 60 dB*3 SELECTOR: L or R	95 MHz WIDE	Ⓑ	X01-1290 L8	Minimale Klirr
21	STEREO KANAL TRENNUNG (1)	dito	dito	95 MHz NARROW	dito	X04-1110 VR9	Minimales Übersprechen
22	STEREO KANAL TRENNUNG (2)	dito	dito	95 MHz WIDE	dito	X04-1110 VR8	dito
23	STEREO KANAL TRENNUNG (3)	dito	95 MHz 10 kHz, 68,25 kHz Hub*13 60 dB*3 SELECTOR: L or R	dito	dito	X04-1110 FL2	dito *14
Abstimmungen „20 bis 30“ mehrere Male wiederholen.							
24	STEREO KANAL TRENNUNG (4)	Ⓒ	95 MHz 1 kHz, 68,25 kHz Hub *13 60 dB*3 SELECTOR: L or R	95 MHz NORMAL	Ⓑ	X13-2600 VR1	Minimales Übersprechen
25	SCA (1)	Ⓐ	95 MHz 67 kHz, 6,75 kHz Hub 60 dB* SELECTOR: L+R	dito	Gleichstrom- Voltmeter an die Anode von D4 (X04-1110)	X04-1110 L6	Maximale Gleichstrom- Spannung
26	SCA (2)	dito	dito	dito	Gleichspan- nungsmesser zu Klemme 7 von IC2 (X04-1110)	X04-1110 VR4	*15
27	D METER	dito	95 MHz 1 kHz, 75 kHz Hub 60 dB*3	95 MHz NORMAL METER: DEVIATION	D meter	X04-1110 VR7	D-meter gibt 100% an.
28	VIELWEG- METER	AG zum An- schlusspunkt von R123 und C83 (X02-1150) Beide Enden von R33 kurz- schliessen	38 kHz	95 MHz NORMAL METER: MULTIPATH	Vielweg- Meter	X02-1150 L28,29	Maximaler Ausschlag

## ABGLEICH

### PRÜFINSTRUMENTE

Oszilloskop.....	OSC
UKW-Signalgenerator.....	FM-SG
NF-Signalgenerator.....	AG
Transistor-Voltmeter.....	SSVM
UKW-Multiplexgenerator.....	FM-MPX
Frequenzzähler	
Gleichspannungsmesser	

- \*1 Für präzise Einstellung muß das SG (75Ω Ausgangs-Impedanz) direkt an den Tuner angeschlossen werden. Dazu ein Kabel mit einem BNC-Stecker am einen Ende und einem F-Stecker am anderen Ende verwenden. Wird ein offenes SG (zur Angabe des Ausgangspegels wenn keine zusätzliche Belastung angeschlossen ist) verwendet, 6 dB von der SG-Angabe subtrahieren um den ANT-Eingangspegel zu erhalten. Ist die Ausgangs-Impedanz von SG 50Ω, das 50Ω : 75Ω Kunstantenna der neuen IHF-Norm verwenden.

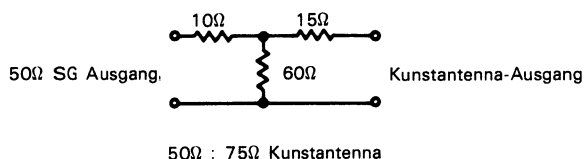

Bei Verwendung eines offenen SG, 12 dB von der SG-Angabe subtrahieren, um den ANT-Eingangspegel zu erhalten. Wird ein belastetes SG (Angabe des Ausgangspegels bei Anschluss von 50Ω) verwendet, 6 dB von der SG Angabe subtrahieren.

- \*2 Den Abstimmknopf so einstellen, daß an der oberen und unteren Grenze der Ausgangswellenform bei schwachem Signal dasselbe Geräusch auftritt.

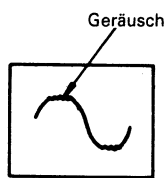

- \*3 Tuner-Eingangspegel

\*4

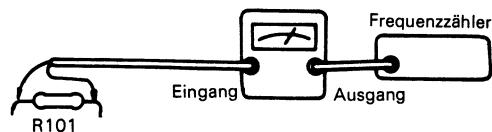

Da der Ausgangspegel niedrig ist, muß das Ausgangssignal durch SSVM verstärkt werden.

- \*5 Das heiße Ende des R101 an den senkrechten Eingang und Stift 4 des IC13 an den waagrechten Eingang des Oszilloskop anschließen, so daß die Lissajous'sche Zahl erreicht wird. Die Verbindung zwischen C17 und R111 erden.

- \*6 Lissajous'sche Figur



- \*7 Gleichspannungsmesser an Stift 1 des IC6 (X13-2610) anschließen und Stift 7 des IC1 mit Stift 3 des IC1 kurzschließen.
- \*8 Den Körper von C16 (X04-1110) mit der heißen Klemme des SSVM Eingangskabels einklemmen und den SSVM-Ausgang zum Frequenzzähler leiten.
- \*9 Wird ein offenes SG via einen F-Stecker direkt an den Tuner angeschlossen, den SG-Ausgang auf 74,8 dB einstellen. Falls dies nicht möglich ist, auf 74,5 dB einstellen.
- \*10 VR3 drehen, bis LED ausgeht; dann etwas in entgegengesetzter Richtung drehen, bis LED wieder aufleuchtet.
- \*11 Ausgang, der den Feldstärkeinstrument 20 dBf anzeigen läßt.
- \*12 VR4 drehen, bis die Ausgangs-Wellenform verschwindet; dann leicht in der entgegengesetzten Richtung drehen, bis die Ausgangswellenform wieder erscheint.
- \*13 Hub mit dem Wahlschalter auf L+R auf 68,25 kHz einstellen. Hub des Kontrollsignals auf 6,75 kHz (9%) einstellen.
- \*14 Ist die Trennung ungenügend, VR5 und VR6 innerhalb von ±3° drehen (wird über ±5° gedreht, so wird die 1 kHz-Trennung negativ beeinträchtigt).
- \*15 VR4 so einstellen, daß die Voltmeter-Angabe von positiv auf negativ umschlägt.

## ADJUSTMENT

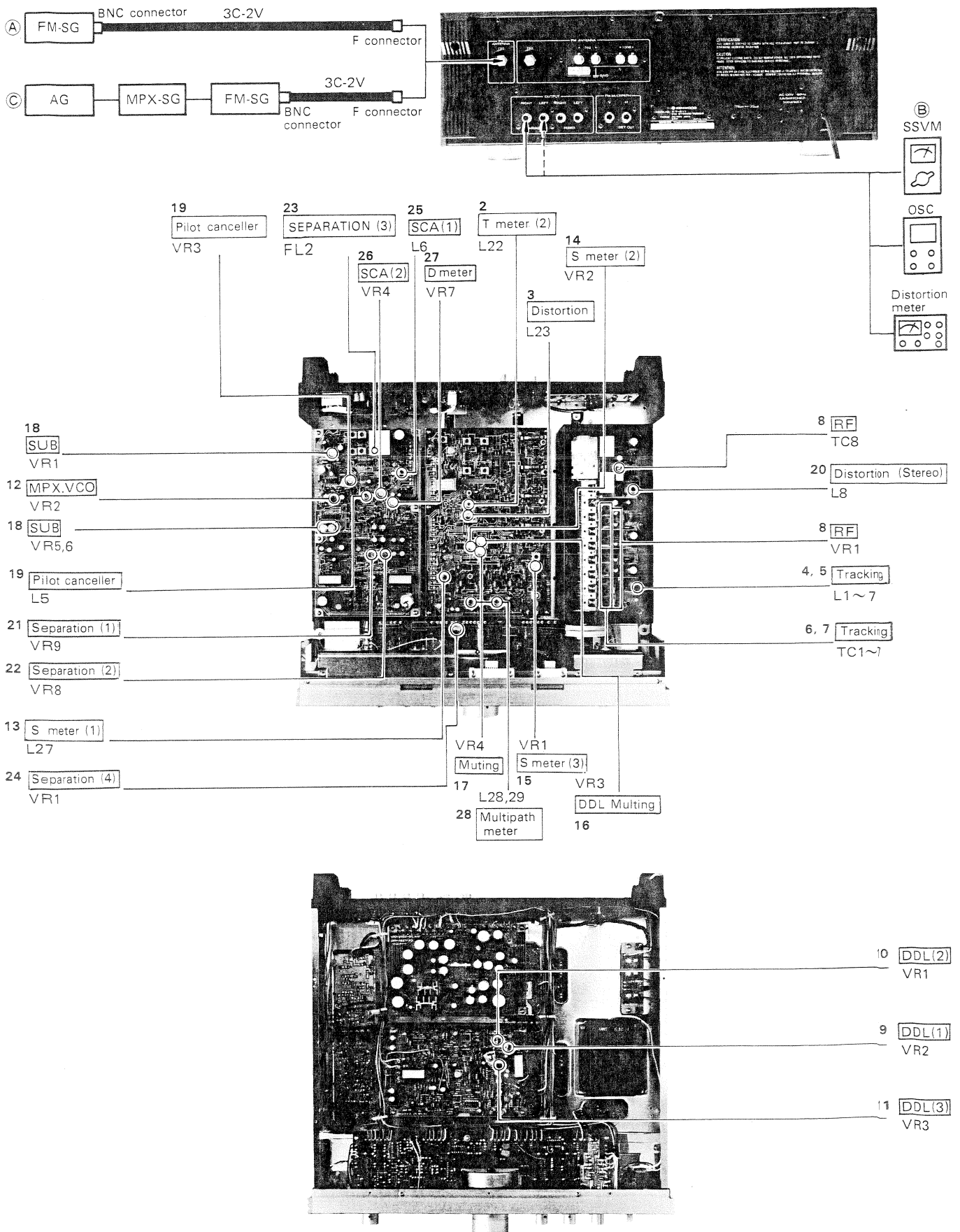

**PC BOARD**

**▼ POWER SUPPLY (X00-2020-11) COMPONENT SIDE**

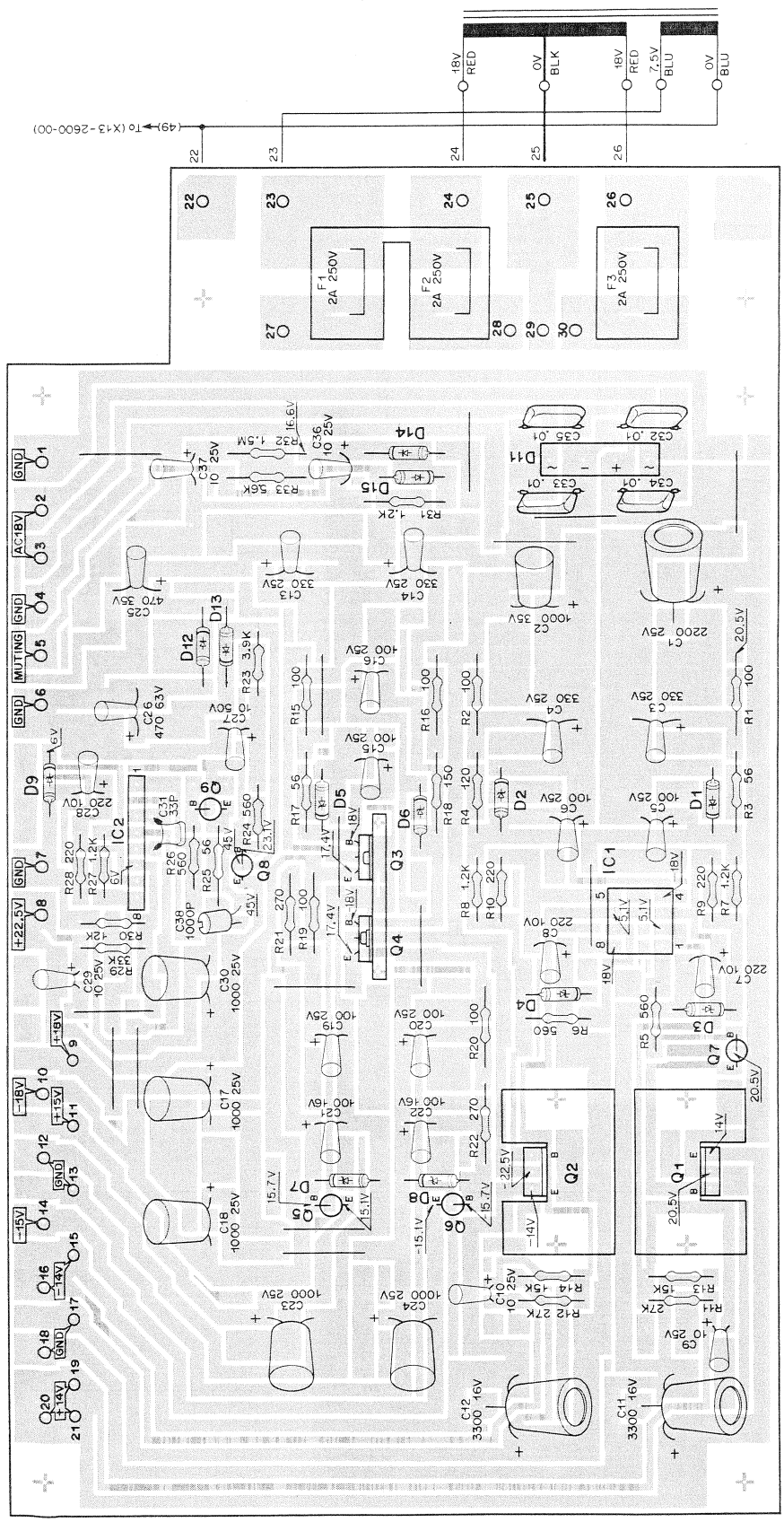

- |      |                |          |                    |
|------|----------------|----------|--------------------|
| O1,3 | : 2SD330 (E,F) | D12 ~ 14 | : W0-6B            |
| O2,4 | : 2SB514 (E,F) | D15      | : 1S2076 or 1S1555 |
| O5,8 | : 2SC1735      | IC1      | : NJM4558D         |
| O6   | : 2SA850       | IC2      | : HA1457           |
| O7,9 | : 2SC945 (R,Q) | D9       | : XZ-060           |
|      |                | D11      | : RB151            |
- 
- |        |         |        |        |
|--------|---------|--------|--------|
| 25A850 | 2SC1735 | 2SB514 | 2SD330 |
|--------|---------|--------|--------|
- 
- |        |  |  |  |
|--------|--|--|--|
| 2SC945 |  |  |  |
|--------|--|--|--|



PC BOARD

▼ RF (X01-1290-11) COMPONENT SIDE

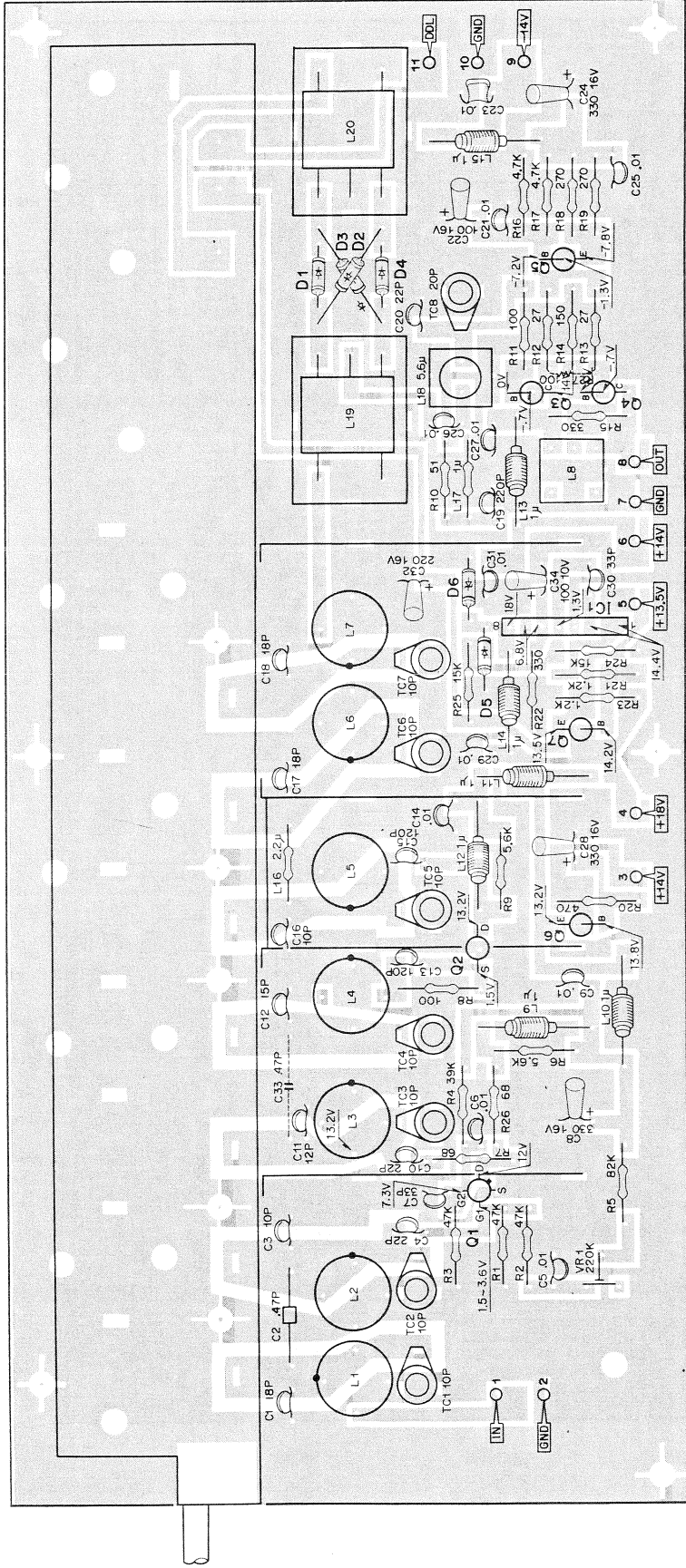

- O1 : CC3588DE
- O2 : 2SK125
- O3,4 : 2SC2408
- O5 : 2SC1735 (E)
- O6,7 : 2SC1384 (Q,R)
- D1 ~ 4 : 1SS97
- D5 : 1S2076 or 1S1555
- D6 : XZ-060
- IC1 : HA1457
- CC3588DE
- 2SK125
- 2SC2408
- 2SC1735
- 2SC1384

## PC BOARD

▼ IF (X02-1150-00) COMPONENT SIDE

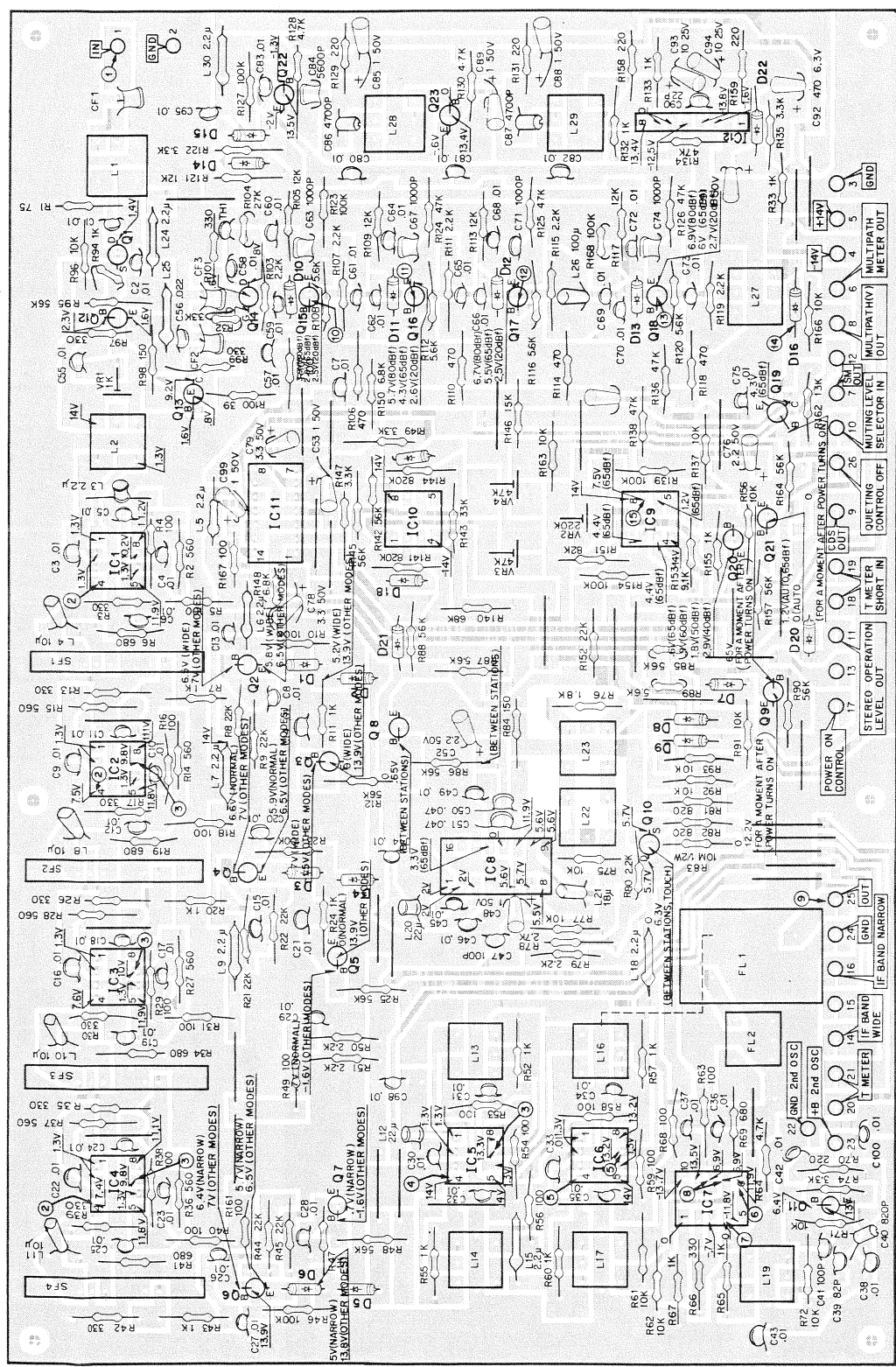

- Q14 : 2SK125
- D1 ~ 9.17 ~ 21 : 2SK55 (E)
- D10 ~ 15 : M8513A-0
- D16.22 : 1N60
- IC1 ~ 0 : LA1ZZZ
- IC7 : MC1496K
- IC8 : HA1137W
- IC9.10 : NJM4558D
- IC11 : TC4011P
- IC12 : HA1457

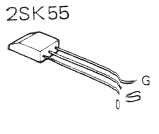
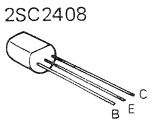
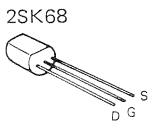
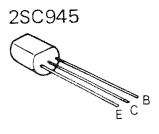
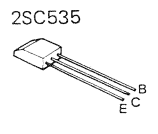
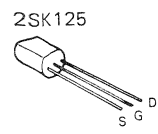

**PC BOARD**

▼ **PULSE COUNT DETECTOR**  
(X02-1160-00)  
**COMPONENT SIDE**

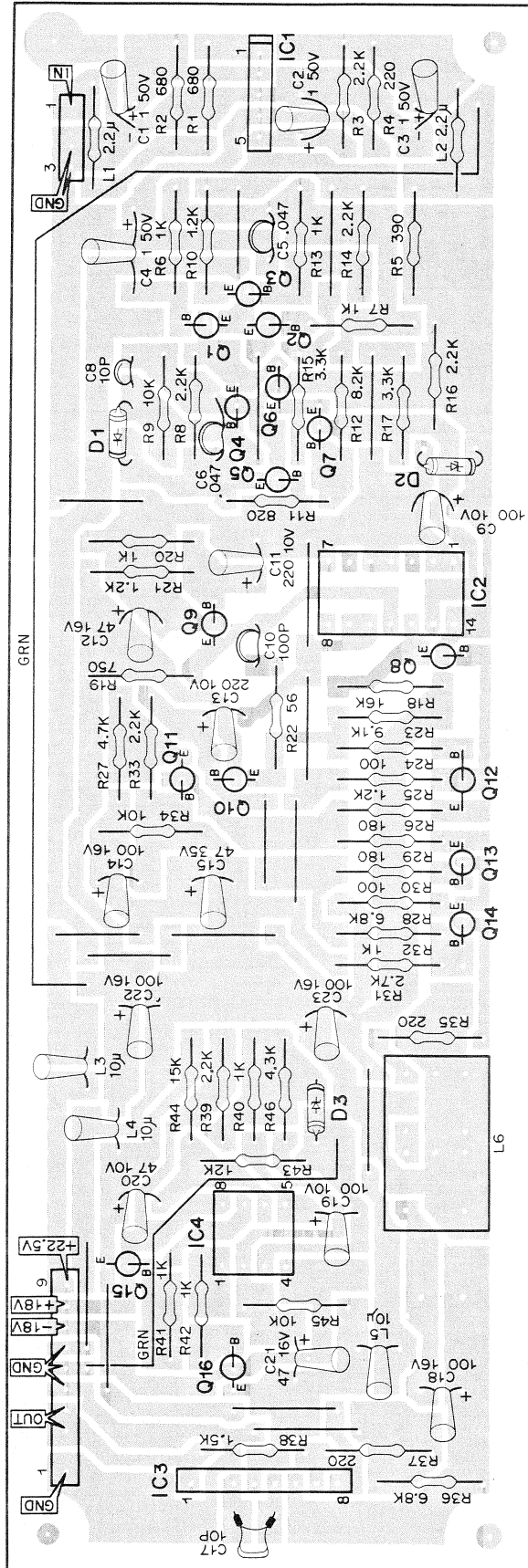

2SA733A  
2SC1384

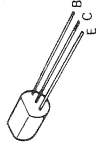

2SA836  
2SC535

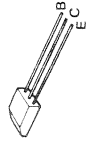

D1 : 1S1555 or 1S2076  
D2 : XZ-053  
D3 : XZ-060  
IC1 : TA7060P  
IC2 : SN74LS38N  
IC3 : HA1457  
IC4 : NJM4559D

Q1 ~ 8,10 : 2SC535 (C)  
Q9,11 ~ 14 : 2SA836 (E)  
Q15 : 2SC1384 (R,Q)  
Q16 : 2SA733A (R,Q)



## PC BOARD

### ▼ MPX (X04-1110-11) COMPONENT SIDE

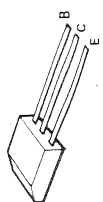

2SA915  
2SC1940

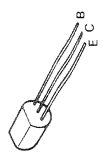

2SA733A  
2SA872  
2SC945

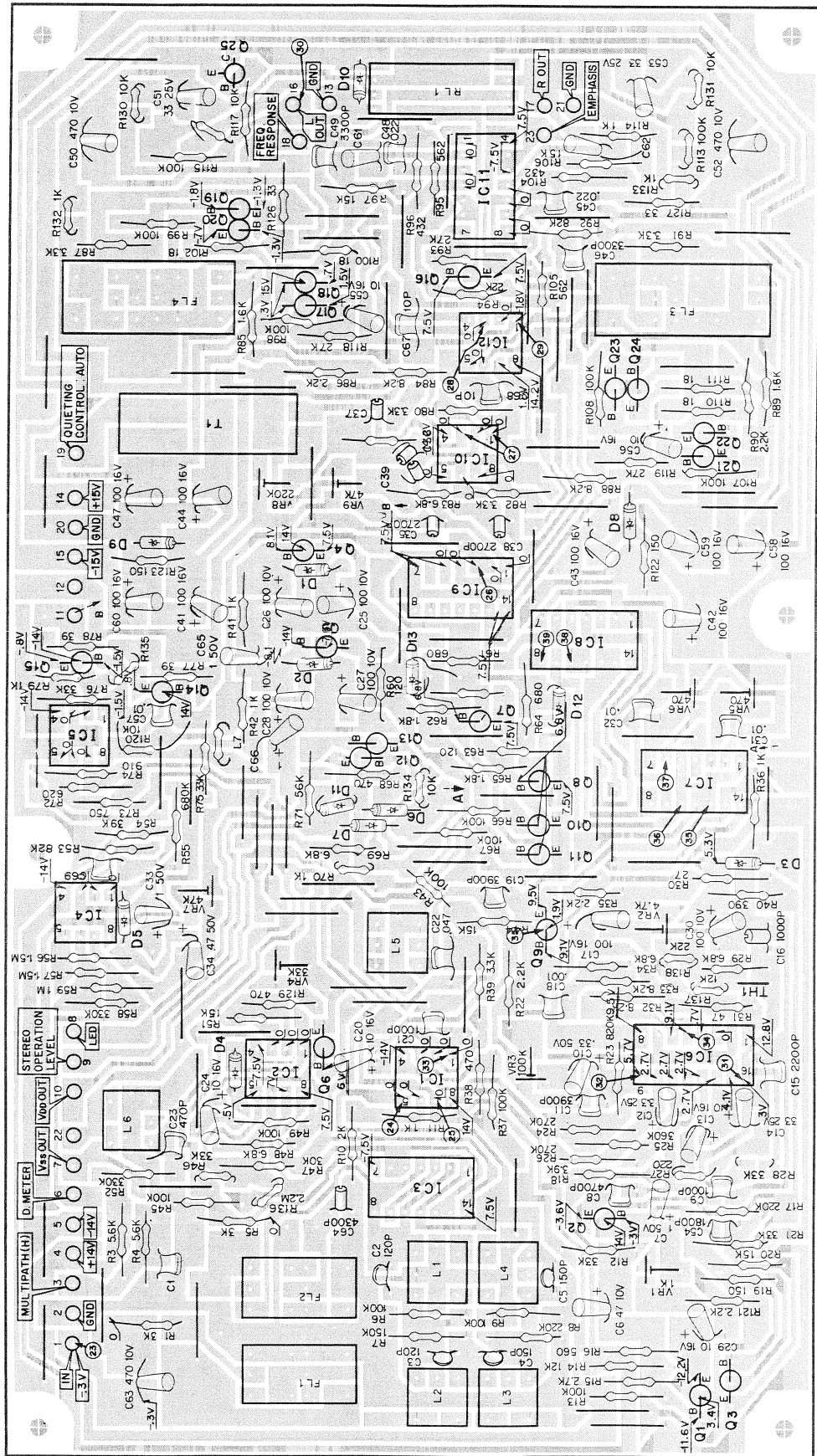

Q1 ~ 3.6, 12, 13, 25	2SC945 (O.R)	Q18, 22	2SC1940 (K)	D8, 9	XZ-142	IC3, 9, 11	TC4066BP
Q4	2SC1384 (O.R)	Q20, 24	2SA915 (K)	D10	XZ-157	IC6	HA11223W
Q5, 7 ~ 9, 16	2SA733A (O.R)	D1, 2	WZ-081	D12, 13	1N60	IC7	SN74LS04N
Q10, 11	2SC945 (O)	D3	XZ-053	IC1, 4, 5, 12	NJM4559D (F)	IC8	SN74LS00N
Q14, 17, 21	2SC1775 (E)	D4 ~ 7, 11	1S1555	IC2	NJM4559D (B)	IC10	TL072CP
Q15, 19, 23	2SA872 (E)						

PC BOARD

▼ SWITCH (X13-2620-00) FOIL SIDE

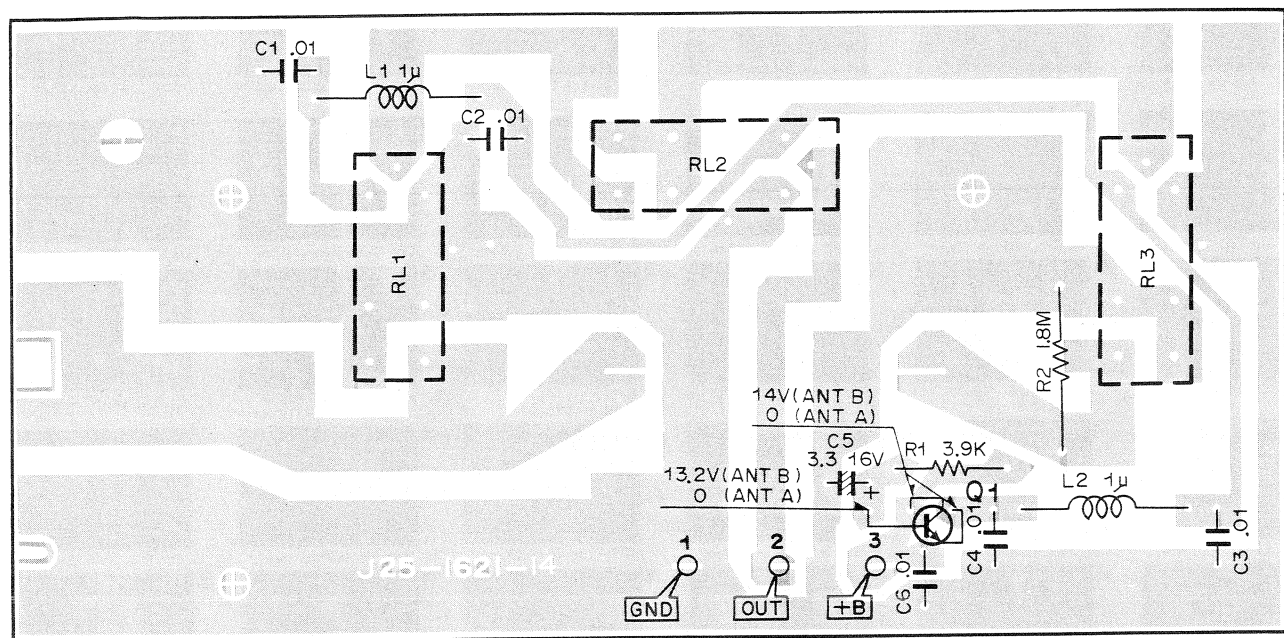

2SC945  
  
 Q1 : 2SC945

▼ SWITCH (X13-2600-00) COMPONENT SIDE

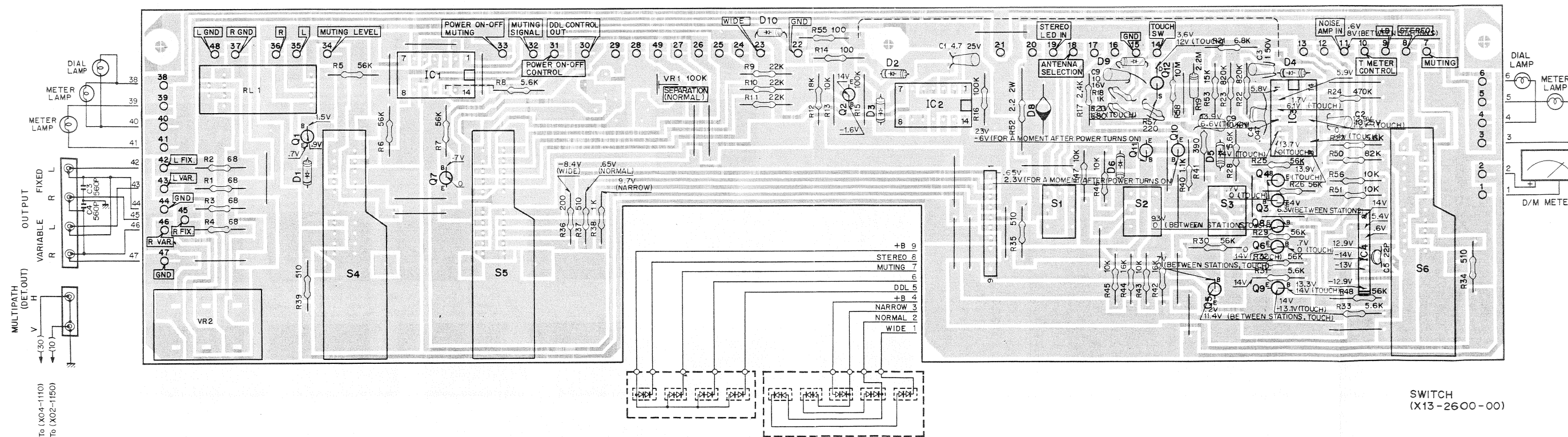

SWITCH (X13-2600-00)

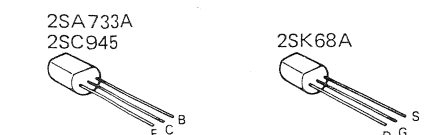

- |             |                    |       |             |
|-------------|--------------------|-------|-------------|
| Q1 ~ 8      | : 2SC945 (R,Q)     | D8    | : W06B      |
| Q9 ~ 11     | : 2SA733A (R,Q)    | IC1   | : TC4081BP  |
| Q12         | : 2SK68 (M)        | IC2,3 | : TC4069UBP |
| D1 ~ 6,9,10 | : 1S1555 or 1S2076 | IC4   | : HA1457    |



PC BOARD

▼ DDL (X13-2610-11) COMPONENT SIDE

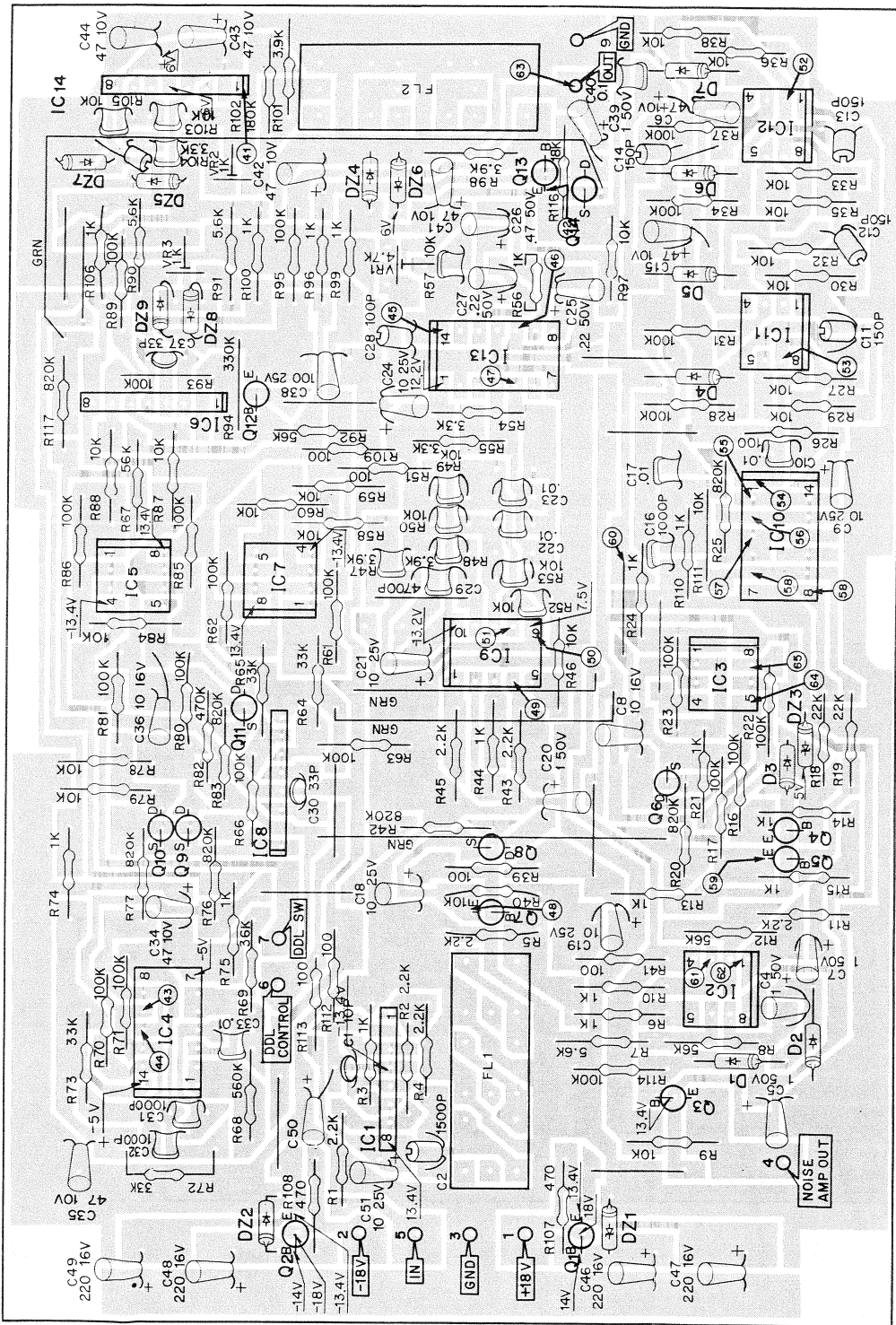

2SA684 2SC1384  
2SA733A 2SC1775  
2SC945

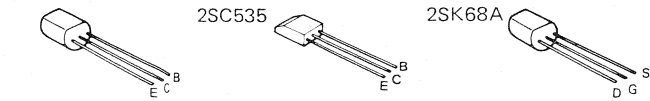

- Q1 : 2SC1384 (Q)
- Q2 : 2SA684 (Q)
- Q3 : 2SC945 (R,Q)
- Q4,5 : 2SC535 (B)
- Q6,8 ~ 11 : 2SK68A (M)
- Q7,13 : 2SC1775 (E)
- Q12 : 2SA733 (R,Q)
- Q14 : 2SK68
- D1,2,8,9 : 1S1555
- D3 ~ 7 : M8513A-0
- DZ1,2 : EOA01-14R
- DZ3 : EOA01-05R
- DZ4 ~ 7 : EOA01-06S
- IC1,6,8,14 : HA1457
- IC2,3,11,12 : NJM4559D (F)
- IC4 : TC4011P
- IC5,7 : NJM4558D (A)
- IC9 : MC1496K
- IC10 : TC4069P
- IC13 : HA1156W

WAVEFORMS AT CHECK POINTS

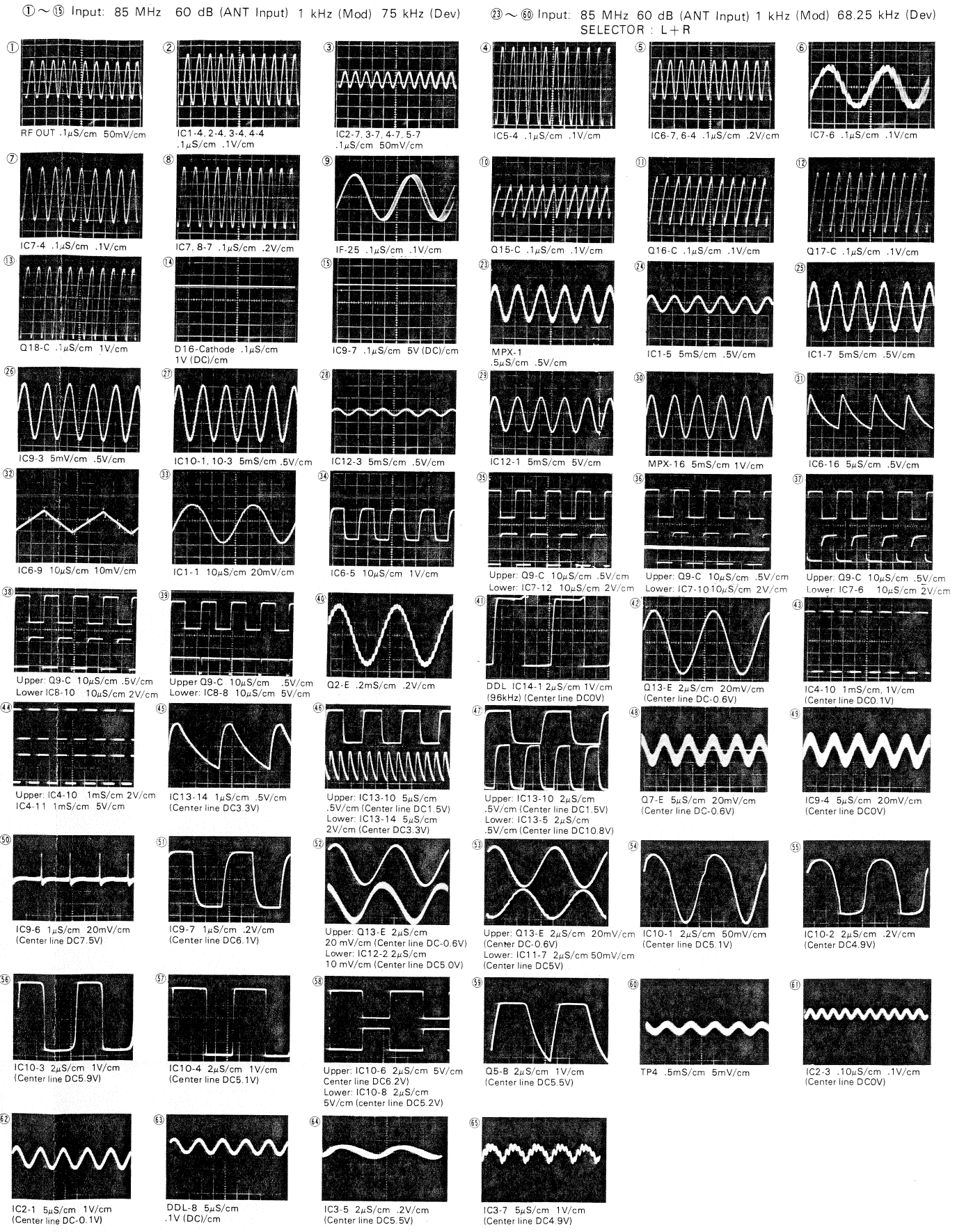

- 2SA850
- 2SC1735
- 2SA564A
- 2SA694
- 2SA733A
- 2SA872
- 2SA893
- 2SA992
- 2SC828A
- 2SC945
- 2SC1384
- 2SC1775
- 2SC1885
- 2SC1890
- 2SC1980
- 2SB514
- 2SD330
- 2SC2408
- 2SA836
- 2SC535
- 2SA915
- 2SC1213A
- 2SC1940
- CC3588DE
- 2SK125
- 2SK30A
- 2SK68
- 2SK68A
- 2SK105
- 2SK55
- 2SK19
- 2SC381
- 2SC734
- 2SC1567
- HA1122W
- HA1137W
- NM4558D
- NM4599D
- LA1222
- TL072CP
- TC4011BP
- TC4068BP
- TC4069
- TC4081BP
- SN74LS04N
- SN74LS00M
- SN74LS38M
- HA1156W
- TA7060P
- HA1457
- MC1496K

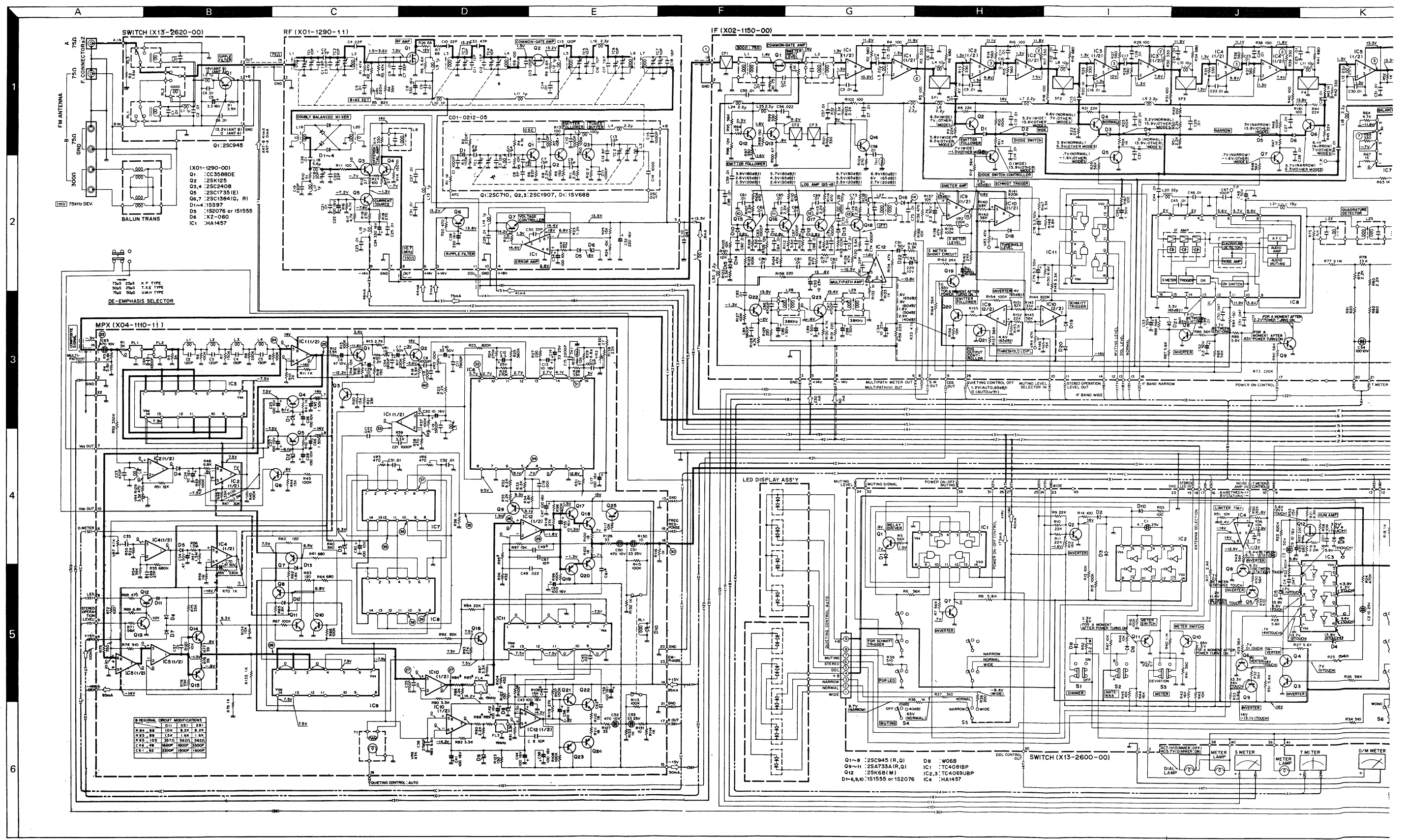

REGIONAL CIRCUIT MODIFICATIONS

REGION	Q1	Q2	Q3	Q4	Q5	Q6	Q7	Q8	Q9	Q10	Q11	Q12	Q13	Q14	Q15	Q16	Q17	Q18	Q19	Q20	Q21	Q22	Q23	Q24	Q25	
USA	2SC1735	2SC1735	2SC1735	2SC1735	2SC1735	2SC1735	2SC1735	2SC1735	2SC1735	2SC1735	2SC1735	2SC1735	2SC1735	2SC1735	2SC1735	2SC1735	2SC1735	2SC1735	2SC1735	2SC1735	2SC1735	2SC1735	2SC1735	2SC1735	2SC1735	
EUROPE	2SC1735	2SC1735	2SC1735	2SC1735	2SC1735	2SC1735	2SC1735	2SC1735	2SC1735	2SC1735	2SC1735	2SC1735	2SC1735	2SC1735	2SC1735	2SC1735	2SC1735	2SC1735	2SC1735	2SC1735	2SC1735	2SC1735	2SC1735	2SC1735	2SC1735	2SC1735
JAPAN	2SC1735	2SC1735	2SC1735	2SC1735	2SC1735	2SC1735	2SC1735	2SC1735	2SC1735	2SC1735	2SC1735	2SC1735	2SC1735	2SC1735	2SC1735	2SC1735	2SC1735	2SC1735	2SC1735	2SC1735	2SC1735	2SC1735	2SC1735	2SC1735	2SC1735	2SC1735

- Q1~8 : 2SC945 (R,Q)
- Q9~11 : 2SA733A (R,Q)
- Q12 : 2SK68 (M)
- D1~4, 9, 10, 15, 1555 or 152076
- D8 : W068
- IC1 : TC4081BP
- IC2, 3 : TC4069UBP
- IC4 : HA1457



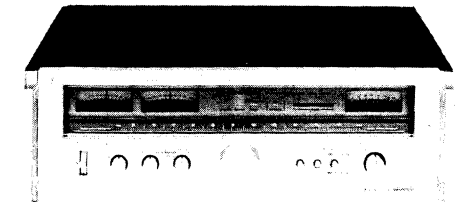
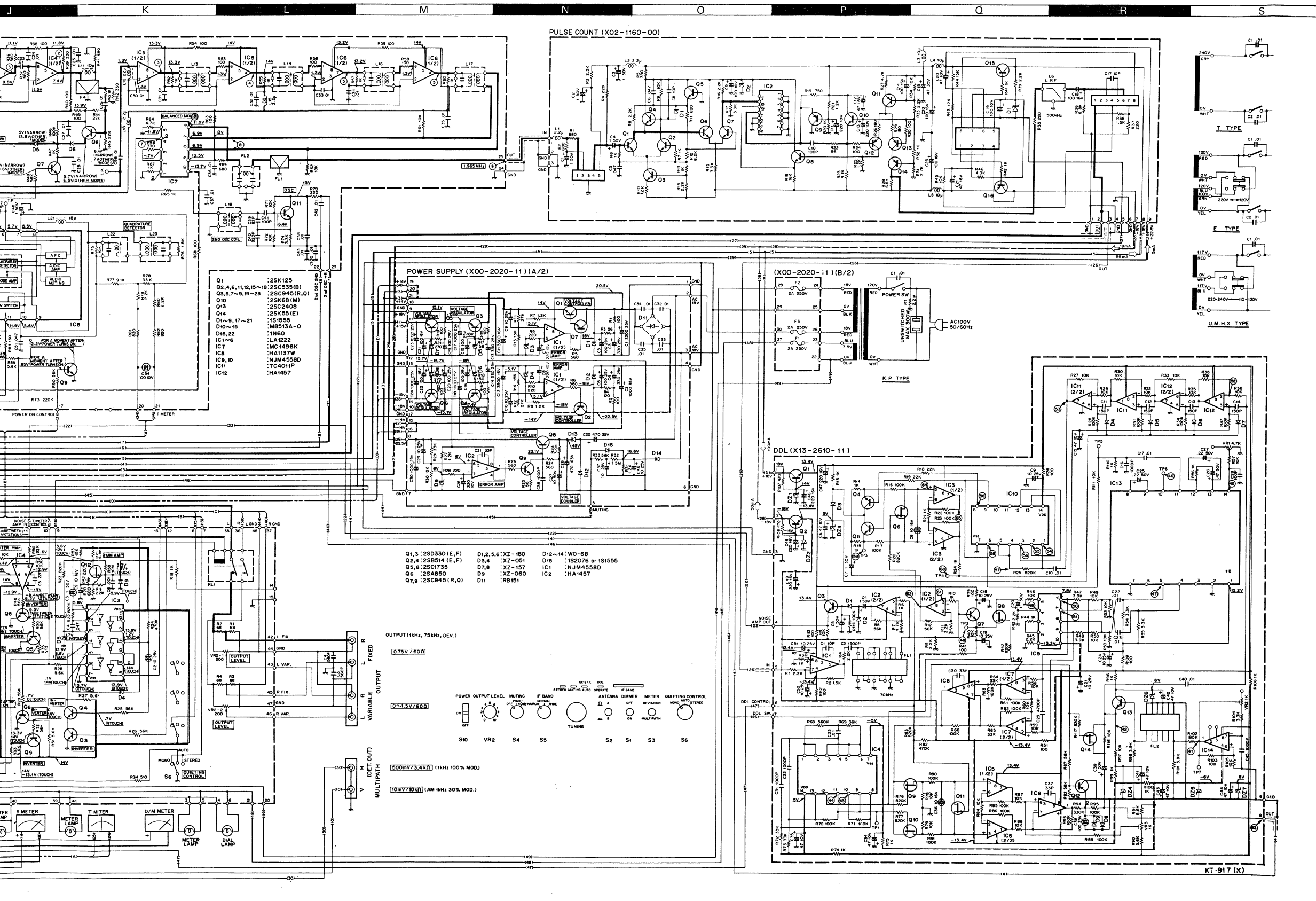

**SPECIFICATIONS**

**PERFORMANCE**

Usable Sensitivity	10.8 dBf (1.9 μV)		
50 dB Quieting Sensitivity (Mono)	15.8 dBf (3.4 μV)		
	(Stereo)	37.2 dBf (40 μV)	
Signal to Noise Ratio (Mono)	90 dB		
	(Stereo)	84 dB	
Total Harmonic Distortion	WIDE	NORMAL	NARROW
(Mono) 100 Hz	0.02%	0.02%	0.02%
1,000 Hz	0.03%	0.06%	0.15%
6,000 Hz	0.05%	0.15%	0.4%
15,000 Hz	0.03%	0.03%	0.03%
(Stereo) 50 Hz ~ 10,000 Hz	0.05%	0.15%	0.4%
100 Hz	0.06%	0.1%	0.2%
1,000 Hz	0.04%	0.09%	0.12%
6,000 Hz	0.07%	0.15%	0.2%
15,000 Hz	0.25%	0.4%	0.9%
50 Hz ~ 10,000 Hz	0.09%	0.2%	0.25%
Capture Ratio	0.8 dB	1.4 dB	1.7 dB
Alternate Channel Selectivity	35 dB	60 dB	60 dB
			(300 kHz)
Stereo Separation			
1,000 Hz	60 dB	55 dB	50 dB
50 Hz ~ 10,000 Hz	50 dB	45 dB	40 dB
15,000 Hz	40 dB	38 dB	33 dB
Frequency Response	10 Hz to 16,000 Hz		
	+ 0.2 dB - 0.5 dB		
Spurious Response Ratio	125 dB		
Image Response Ratio	125 dB		
IF Response Ratio	125 dB		
AM Suppression Ratio	70 dB		
Sub Carrier Product Ratio	73 dB		
SCA Rejection Ratio	75 dB		
Antenna Impedance	75 ohms unbalanced and 300 ohms balanced		
FM Frequency Range	88 MHz to 108 MHz		
Output Level at 1 kHz			
100% Mod Fixed	0.75V, 60 ohms		
	Variable	0 ~ 1.5V, 60 ohms	
Multipath Output	Vertical	0.01V, 10k ohms	
	Horizontal	0.5V, 3k ohms	

**GENERAL**

Power Consumption	55 watts
AC Outlet	UNSWITCHED 1
Dimension	W 460 mm (18 1/8")
	H 161 mm (6 11/32")
	D 463 mm (18 7/32")
Net Weight (less handles)	15 kg (33 1 lbs)

**NOTE:**  
 Kenwood follows a policy of continuous advancements in development.  
 For this reason Specifications may be changed.

DC voltages are measured with 25 kΩ/V VOM.



PARTS LIST

☆: New parts
RD: Carbon film resistor
RC: Carbon composition resistor
RW: Wire wound power resistor
RN: Metal film resistor
RS: Metal oxide film resistor

Note: Carbon film resistors are not detailed in PARTS LIST. With regard to the value, refer to the Schematic diagram or the PC board drawings.

UNIT (Y07-1280-00)

☆: New Parts

Table with 4 columns: Ref. No., Parts No., Description, Remarks. Lists various components like Case, Panel ass'y, Escutcheon, Front glass, Lighting plate, Dial calibrations, Dial pointer ass'y, Lamp, Meter, S meter, T meter, LED ass'y, Warranty card, Instruction manual, Kenwood service stations' list, Metalized polyester capacitor, Ceramic capacitor, Dial pulley, Pulley, and Dial shaft ass'y.

PARTS LIST

Table with 4 columns: Ref. No., Parts No., Description, Remarks. Lists components like Slide switch (DE-EMPHASIS), Slide switch (POWER VOLTAGE SELECTOR), Lever switch (POWER), FM indoor antenna, Hexagonal wrench, Power supply PC board ass'y, RF PC board ass'y, IF PC board ass'y, Pulse count detector PC board ass'y, MPX PC board ass'y, DDL PC board ass'y, and Switch PC board ass'y.

POWER SUPPLY (X00-2020-00, 0-11, 2-71)

Table with 4 columns: Ref. No., Parts No., Description, Remarks. Lists components under CAPACITOR, RESISTOR, and other power supply related parts.

Table with 4 columns: Ref. No., Parts No., Description, Remarks. Lists various semiconductor components like Transistor, Diode, Zener diode, IC, Fuse, and Fuse holder.

RF (X01-1290-11)

Table with 4 columns: Ref. No., Parts No., Description, Remarks. Lists RF components like Ceramic capacitors and resistors.

Table with 2 columns: Ref. No., Description. Lists various component types and values like C10, C11, C12, C13, C14, C15, C16, C17, C18, C19, C20, C21, C22, C23, C24, C25, C26, C27, C28, C29, C30, C31, C32, C33, C34, R7, R8, R20, R26, Q1, Q2, Q3, Q4, Q5, Q6, Q7, Q8, Q9, D1, D2, D3, D4, D5, D6, V1, V2, V3, V4, V5, V6, V7, V8, V9, V10, V11, V12, V13, V14, V15, V16, V17, V18, V19, V20, V21, V22, V23, V24, V25, V26, V27, V28, V29, V30, V31, V32, V33, V34, V35, V36, V37, V38, V39, V40, V41, V42, V43, V44, V45, V46, V47, V48, V49, V50, V51, V52, V53, V54, V55, V56, V57, V58, V59, V60, V61, V62, V63, V64, V65, V66, V67, V68, V69, V70, V71, V72, V73, V74, V75, V76, V77, V78, V79, V80, V81, V82, V83, V84, V85, V86, V87, V88, V89, V90, V91, V92, V93, V94, V95, V96, V97, V98, V99, V100.



PARTS LIST

Ref. No.	Parts No.	Description	Re- marks
<b>SEMICONDUCTOR</b>			
Q1~8	V03-0420-05	Transistor 2SC535(C)	☆
Q9	V01-0836-10	Transistor 2SA836(E)	
Q10	V03-0420-05	Transistor 2SC535(C)	
Q11~14	V01-0836-10	Transistor 2SA836(E)	
Q15	V03-0373-05	Transistor 2SC1384(Q,R)	
Q16	V01-0733-30	Transistor 2SA733A(R,Q)	
IC1	V30-0087-05	IC TA7060P	☆
IC2	V30-0287-20	IC SN74LS38N	
IC3	V30-0264-10	IC HA1457	
IC4	V30-0248-10	IC NJM4558D(A)	
D1	V11-0076-05	Diode 1S1555	
	V11-0271-05	or 1S2076	
D2	V11-4101-60	Zener diode XZ-053	
D3	V11-4101-20	Zener diode XZ-060	
<b>INDUCTOR/FILTER</b>			
L1,2	L40-2292-11	Ferri-inductor 2.2μH	☆
L3~5	L40-1001-25	Ferri-inductor 10μH	
L6	L79-0078-05	LC filter	

Ref. No.	Parts No.	Description	Re- marks
C47	C24-1210-71	Electrolytic 100μF 16WV	
C48	C46-1722-34	Mylar 0.022μF ±2%	
C49	C46-1716-24	Mylar 1600pF ±2% -11, -51	
	C46-1733-24	Mylar 3300pF ±2% -11, -51	
C50	C90-0382-05	Electrolytic 470μF 20WV	☆
C51	C26-1433-67	Electrolytic (NP) 33μF 25WV	
C52	C90-0382-05	Electrolytic 470μF 10WV	☆
C53	C26-1433-67	Electrolytic (NP) 33μF 25WV	
C54	C46-1718-25	Mylar 1800pF ±5%	
C55,56	C24-1210-61	Electrolytic 10μF 16WV	
C57	C46-1710-35	Mylar 0.01μF ±5%	
C58~60	C24-1210-71	Electrolytic 100μF 16WV	
C61.62	C46-1733-24	Polystyrene 3300pF ±2% -11	
	C46-1718-24	Polystyrene 1800pF ±2% -51	
	C46-1716-24	Polystyrene 1600pF ±2% 2-81	
	C90-0382-05	Electrolytic 470μF 10WV	
C63	C48-1743-24	Polystyrene 4300pF ±2%	☆
C64	C24-1710-51	Polyester 0.022μF ±5%	
C65.66	C91-0050-05	Polystyrene 10pF	
C67.68	C91-0055-05	Polystyrene 27pF	
C69	C26-1747-47	Electrolytic (NP) 0.47μF 50WV	
C70			

MPX (X04-1110-11, -51, 2-81)

Ref. No.	Parts No.	Description	Re- marks
<b>CAPACITOR</b>			
C2.3	C71-1712-16	Ceramic 120pF ±10%	
C4.5	C71-1715-16	Ceramic 150pF ±10%	
C6	C24-1047-61	Electrolytic 47μF 10WV	
C7	C24-1710-51	Electrolytic 1μF 50WV	
C8	C46-1747-25	Mylar 4700pF ±5%	
C9	C46-1710-25	Mylar 1000pF ±5%	
C10	C25-1733-47	Electrolytic 0.33μF 50WV	
C11	C46-1739-25	Mylar 3900pF ±5%	
C12	C25-1433-57	Electrolytic 3.3μF 25WV	
C13	C25-1210-67	Electrolytic 10μF 16WV	
C14	C25-1433-67	Electrolytic 33μF 25WV	
C15	C46-1722-25	Mylar 2200pF ±5%	
C16	C48-1710-25	Polystyrene 1000pF ±5%	
C17	C24-1210-71	Electrolytic 100μF 16WV	
C18	C46-1710-25	Mylar 0.01μF ±5%	
C19	C46-1739-25	Mylar 3900pF ±5%	
C20	C24-1210-61	Electrolytic 10μF 16WV	
C21	C46-1710-25	Mylar 1000pF ±5%	
C22	C46-1747-35	Mylar 0.047μF ±5%	
C23	C71-1747-16	Ceramic 470pF ±10%	
C24	C24-1210-61	Electrolytic 10μF 16WV	
C25~28	C24-1010-71	Electrolytic 100μF ±10%	
C29	C24-1210-61	Electrolytic 10μF 16WV	
C30	C24-1010-71	Electrolytic 100μF 10WV	
C31.32	C46-1710-35	Mylar 0.01μF ±5%	
C33	C46-1710-45	Mylar 0.1μF ±5%	
C34	C25-1747-47	Electrolytic 0.47μF 50WV	
C35	C47-1727-25	Polystyrene 2700pF ±5%	
C38	C47-1727-25	Polystyrene 2700pF ±5%	
C41~44	C24-1210-71	Electrolytic 100μF 16WV	
C45	C46-1722-34	Mylar 0.022μF ±2%	
C46	C46-1716-24	Mylar 1600pF ±2% -11, -51	
	C46-1733-24	Mylar 3300pF ±2% 2-81	

Ref. No.	Parts No.	Description	Re- marks
<b>RESISTOR</b>			
R1	R48-2230-25	Metal film 3kΩ ±5% 1/4W	
R3.4	R48-2256-25	Metal film 5.6kΩ ±5% 1/4W	
R5	R48-2230-25	Metal film 3kΩ ±5% 1/4W	
R6	R48-2210-45	Metal film 100kΩ ±5% 1/4W	
R7	R48-2215-45	Metal film 150kΩ ±5% 1/4W	
R8	R48-2222-45	Metal film 220kΩ ±5% 1/4W	
R9	R48-2210-45	Metal film 100kΩ ±5% 1/4W	
R10	R48-2220-25	Metal film 2kΩ ±5% 1/4W	
R11	R48-2210-25	Metal film 1kΩ ±5% 1/4W	
R12	R48-2233-35	Metal film 33kΩ ±5% 1/4W	
R13	R48-2210-45	100kΩ ±5% 1/4W	
R14	R48-2212-35	Metal film 12kΩ ±5% 1/4W	
R15	R48-2227-25	Metal film 2.7kΩ ±5% 1/4W	
R16	R48-2256-15	Metal film 560Ω ±5% 1/4W	
R17	R48-2222-45	Metal film 220kΩ ±5% 1/4W	
R18	R48-2239-25	Metal film 3.9kΩ ±5% 1/4W	
R19	R48-2215-15	150Ω ±5% 1/4W	
R20	R48-2215-35	Metal film 15kΩ ±5% 1/4W	
R21	R48-2233-35	Metal film 33kΩ ±5% 1/4W	
R22	R48-2222-25	Metal film 2.2kΩ ±5% 1/4W	
R23	R48-2282-45	Metal film 820kΩ ±5% 1/4W	
R24	R48-2227-45	Metal film 270kΩ ±5% 1/4W	
R25	R48-2236-45	Metal film 360kΩ ±5% 1/4W	
R26	R48-2227-45	Metal film 270kΩ ±5% 1/4W	
R27	R48-2222-15	Metal film 220Ω ±5% 1/4W	
R28	R48-2233-35	Metal film 33kΩ ±5% 1/4W	
R29	R48-2268-25	Metal film 6.8kΩ ±5% 1/4W	
R30	R43-1227-05	Flame-proof RD 27Ω ±5% 1/4W	
R31	R43-1247-05	Flame-proof RD 47Ω ±5% 1/4W	
R32.33	R48-2282-25	Metal film 8.2kΩ ±5% 1/4W	
R34	R48-2268-25	Metal film 6.8kΩ ±5% 1/4W	
R35	R48-2222-25	Metal film 2.2kΩ ±5% 1/4W	
R36	R48-2210-25	Metal film 1kΩ ±5% 1/4W	
R37	R48-2210-45	Metal film 100kΩ ±5% 1/4W	
R38	R48-2247-15	Metal film 470Ω ±5% 1/4W	
R39	R48-2233-25	Metal film 3.3kΩ ±5% 1/4W	

PARTS LIST

Ref. No.	Parts No.	Description	Re- marks
R40	R43-1239-15	Flame-proof RD 390Ω ±5% 1/4W	
R41.42	R43-1210-25	Flame-proof RD 1kΩ ±5% 1/4W	
R43	R48-2210-45	Metal film 100kΩ ±5% 1/4W	
R44	R48-2215-35	Metal film 15kΩ ±5% 1/4W	
R45	R48-2210-45	Metal film 100kΩ ±5% 1/4W	
R46	R48-2233-35	Metal film 33kΩ ±5% 1/4W	
R47	R48-2230-35	Metal film 30kΩ ±5% 1/4W	
R48	R48-2268-25	Metal film 6.8kΩ ±5% 1/4W	
R49	R48-2210-45	Metal film 100kΩ ±5% 1/4W	
R51	R48-2215-35	Metal film 15kΩ ±5% 1/4W	
R52	R48-2233-45	Metal film 330kΩ ±5% 1/4W	
R53	R48-2282-35	Metal film 82kΩ ±5% 1/4W	
R54	R48-2239-35	Metal film 39kΩ ±5% 1/4W	
R60	R48-2212-15	Metal film 120Ω ±5% 1/4W	
R61	R48-2268-15	Metal film 680Ω ±5% 1/4W	
R62	R48-2218-25	Metal film 1.8kΩ ±5% 1/4W	
R63	R48-2212-15	Metal film 120Ω ±5% 1/4W	
R64	R48-2268-15	Metal film 680Ω ±5% 1/4W	
R65	R48-2218-25	Metal film 1.8kΩ ±5% 1/4W	
R66.67	R48-2210-45	Metal film 100kΩ ±5% 1/4W	
R68	R48-2247-15	Metal film 470Ω ±5% 1/4W	
R69	R48-2268-25	Metal film 6.8kΩ ±5% 1/4W	
R70	R48-2210-25	Metal film 1kΩ ±5% 1/4W	
R71	R48-2256-35	Metal film 56kΩ ±5% 1/4W	
R72	R48-2262-15	Metal film 620Ω ±5% 1/4W	
R73	R48-2275-15	Metal film 750Ω ±5% 1/4W	
R74	R48-2291-15	Metal film 910Ω ±5% 1/4W	
R75.76	R48-2233-35	Metal film 33kΩ ±5% 1/4W	
R77.78	R43-1239-05	Flame-proof RD 39Ω ±5% 1/4W	
R79	R48-3210-25	Metal film 1kΩ ±5% 1/4W	
R80	R48-2233-25	Metal film 3.3kΩ ±5% 1/4W	
R82	R48-2268-25	Metal film 6.8kΩ ±5% 1/4W	
R82	R48-2233-25	Metal film 3.3kΩ ±5% 1/4W	
R83	R48-2268-25	Metal film 6.8kΩ ±5% 1/4W	
R84	R48-2210-35	Metal film 10kΩ ±5% 1/4W	
	R48-2282-35	Metal film 8.2kΩ ±5% 1/4W	-11 -51,2-81
R85	R48-2215-25	Metal film 1.5kΩ ±5% 1/4W	-11
	R48-2216-25	Metal film 1.6kΩ ±5% 1/4W	-51,2-81
R86	R48-2222-25	Metal film 2.2kΩ ±5% 1/4W	
R87	R48-2233-25	Metal film 3.3kΩ ±5% 1/4W	
R88	R48-2210-35	Metal film 10kΩ ±5% 1/4W	
	R48-2282-25	Metal film 8.2kΩ ±5% 1/4W	-11 -51,2-81
R89	R48-2215-25	Metal film 1.5kΩ ±5% 1/4W	-11
	R48-2216-25	Metal film 1.6kΩ ±5% 1/4W	-51,2-81
R90	R48-2222-25	Metal film 2.2kΩ ±5% 1/4W	
R91	R48-2233-25	Metal film 3.3kΩ ±5% 1/4W	
R92	R48-2282-35	Metal film 82kΩ ±5% 1/4W	
R93	R48-2227-35	Metal film 27kΩ ±5% 1/4W	
R94	R48-2222-35	Metal film 22kΩ ±5% 1/4W	
R95	R48-2357-03	Metal film 357Ω ±1% 1/4W	
	R48-2562-03	Metal film 562Ω ±1% 1/4W	-11 -51,2-81

Ref. No.	Parts No.	Description	Re- marks
R96	R48-2432-03	Metal film 432Ω ±1% 1/4W	
R97	R48-2150-23	Metal film 15kΩ ±1% 1/4W	
R98.99	R48-2210-45	Metal film 100kΩ ±5% 1/4W	
R100	R43-1218-05	Metal film 18Ω ±5% 1/4W	
R102	R43-1218-05	Metal film 18Ω ±5% 1/4W	
R104	R48-2432-03	Metal film 432Ω ±1% 1/4W	
R105	R48-2357-03	Metal film 357Ω ±1% 1/4W	
	R48-2562-03	Metal film 562Ω ±1% 1/4W	-11 -51,2-81
R106	R48-2150-23	Metal film 15kΩ ±5% 1/4W	
R107.108	R48-2210-45	Metal film 100kΩ ±5% 1/4W	
R110.111	R43-1218-05	Flame-proof RD 18Ω ±5% 1/4W	
R113	R48-3210-45	Metal film 100kΩ ±5% 1/4W	
R114	R48-2210-25	Metal film 1kΩ ±5% 1/4W	
R115	R48-2210-45	Metal film 100kΩ ±5% 1/4W	
R116	R48-3210-25	Metal film 1kΩ ±5% 1/4W	
R117	R48-2210-35	Metal film 10kΩ ±5% 1/4W	
R118.119	R48-2227-35	Metal film 27kΩ ±5% 1/4W	
R120	R48-2210-35	Metal film 10kΩ ±5% 1/4W	
R121	R48-2222-25	Metal film 2.2kΩ ±5% 1/4W	
R122.123	R48-1215-15	Flame-proof RD 150Ω ±5% 1/4W	
R126.127	R48-2233-05	Metal film 33Ω ±5% 1/4W	
R129	R48-2247-15	Metal film 470Ω ±5% 1/4W	
R130.131	R48-3210-05	Metal film 10Ω ±5% 1/4W	
R132.133	R48-3210-25	Metal film 1kΩ ±5% 1/4W	
R134	R48-2210-35	Metal film 10kΩ ±5% 1/4W	
R135	R48-3210-25	Metal film 1kΩ ±5% 1/4W	
R137	R48-2212-35	Metal film 12kΩ ±5% 1/4W	
R138	R48-2222-35	Metal film 22kΩ ±5% 1/4W	
<b>SEMICONDUCTOR</b>			
Q1~3	V03-0270-05	Transistor 2SC945(R,Q)	
Q4	V03-0373-05	Transistor 2SC1384(Q,R)	
Q5	V01-0733-30	Transistor 2SA733A(R,Q)	
Q6	V03-0270-05	Transistor 2SC945(R,Q)	
Q7~9	V01-0733-30	Transistor 2SA733A(R,Q)	
Q10.11	V03-0293-05	Transistor 2SC945(Q)	
Q12.13	V03-0270-05	Transistor 2SC945(R,Q)	
Q14	V03-1775-20	Transistor 2SC1775(E)	
Q15	V01-0189-05	Transistor 2SA872(E)	
Q16	V01-0733-30	Transistor 2SA733A(R,Q)	
Q17	V03-1775-20	Transistor 2SC1775(E)	
Q18	V03-1940-10	Transistor 2SC1940(K)	
Q19	V01-0189-05	Transistor 2SA872(E)	
Q20	V01-0915-10	Transistor 2SA915(K)	
Q21	V03-1775-20	Transistor 2SC1775(E)	
Q22	V03-1940-10	Transistor 2SC1940(K)	
Q23	V01-0189-05	Transistor 2SA872(E)	
Q24	V01-0915-10	Transistor 2SA915(K)	
Q25	V03-0270-05	Transistor 2SC945(R,Q)	
IC1	V30-0271-40	IC NJM4559D(F)	
IC2	V30-0271-30	IC NJM4559D(B)	
IC3	V30-0301-20	IC TC4066BP	☆
IC4	V30-0271-30	IC NJM4559D(B)	
IC5	V30-0271-40	IC NJM4559D(F)	
IC6	V30-0266-20	IC HA1123BW	
IC7	V30-0301-40	IC SN74LS04N	☆
IC8	V30-0301-30	IC SN74LS00N	☆
IC9	V30-0301-20	IC TC4066BP	☆
IC10	V30-0301-50	IC TLO72CP	☆
IC11	V30-0301-20	IC TC4066BP	☆

PARTS LIST

Ref. No.	Parts No.	Description	Re- marks
IC12	V30-0271-40	IC NJM4559D(F)	
D1.2	V11-0246-05	Zener diode WZ-081	
D3	V11-4101-60	Zener diode XZ-053	
D4~7	V11-0076-05	Diode 1S1555	
D8,9	V11-4103-70	Zener diode XZ-142	
D10	V11-4103-90	Zener diode XZ-157	
D11	V11-0076-05	Diode 1S1555	
D12,13	V11-0051-05	Diode 1N60	
TH1	V22-0022-05	Thermister 5T-31L	
<b>POTENTIOMETER</b>			
VR1	R12-1002-05	PC trimming 1kΩ	
VR2	R12-1028-05	PC trimming 4.7kΩ	
VR3	R12-5002-05	PC trimming 100kΩ	
VR4	R12-1026-05	PC trimming 3.3kΩ	
VR5,6	R12-0003-05	PC trimming 470Ω	
VR7	R12-3004-05	PC trimming 47kΩ	
VR8	R12-5018-05	PC trimming 270kΩ	
VR9	R12-3004-05	PC trimming 47kΩ	
<b>FILTER/RELAY/PHOTO COUPLER</b>			
FL1	L79-0083-05	LC filter	☆
FL2	L76-0002-05	Phase compensator	☆
FL3,4	L79-0082-05	LC filter	☆
L1~4	L35-0048-05	MPX coil	
L5	L35-0044-05	MPX coil	
L6	L35-0050-05	MPX coil	
L7,8	L40-1021-03	Ferri-inductor	
RL1	S51-2037-05	Read relay	
T1	T95-0003-05	Photo coupler	☆

SWITCH (X13-2600-00)

Ref. No.	Parts No.	Description	Re- marks
<b>CAPACITOR</b>			
C1	C26-1447-57	Non-pole electrolytic 4.7μF 25WV	
C2	C26-1410-67	Non-pole electrolytic 10μF 25WV	
C3	C26-1710-57	Non-pole electrolytic 1μF 50WV	
C4	C46-1747-35	Mylar 0.047μF ±5%	
C5	C71-1722-06	Ceramic 22pF ±10%	
C6	C46-1710-25	Mylar 0.001μF ±5%	
C7,8	C46-1715-35	Mylar 0.015μF ±5%	
C9	C24-1210-61	Electrolytic 10μF 16WV	
<b>RESISTOR</b>			
R1~4	R48-2268-05	Metal film 68Ω ±5% 1/4W	
R19	R40-8310-68	RC 10MΩ ±20% 1/4W	
R37	R43-1251-15	Flame-proof RD 510Ω ±5% 1/4W	
R38	R43-1210-25	Flame-proof RD 1kΩ ±5% 1/4W	
R52	R47-1522-95	Flame-proof RS 2.2Ω ±5% 2W	
R58	R40-8310-68	RC 10MΩ ±20% 1/2W	

Ref. No.	Parts No.	Description	Re- marks
<b>SEMICONDUCTOR</b>			
Q1~8	V03-0270-05	Transistor 2SC945(R,Q)	
Q9~11	V01-0733-30	Transistor 2SA733A(R,Q)	
Q12	V09-0122-20	FET 2SK68(M)	
IC1	V30-0299-10	IC TC4081BP	
IC2,3	V30-0297-20	IC TC4069UBP	
IC4	V30-0264-10	IC HA1457	
D1~6	V11-0076-05	Diode 1S1555	
	V11-0271-05	or 1S2076	
D8	V11-0295-05	Diode W06B	
D9,10	V11-0076-05	Diode 1S1555	
	V11-0271-05	or 1S2076	
<b>POTENTIOMETER</b>			
VR1	R12-5025-05	PC trimming 20kΩ(B) Separation (Normal)	
VR2	R10-0001-05	200Ω × 2 OUTPUT LEVEL	☆
<b>SWITCH</b>			
S1~3	S40-2088-05	Push switch	
S4~6	S29-1116-05	Rotary slide switch	☆
<b>RELAY</b>			
RL1	S51-2037-05	Reed relay	

DDL (X13-2610-11, -51)

Ref. No.	Parts No.	Description	Re- marks
<b>CAPACITOR</b>			
C1	C71-1710-06	Ceramic 10pF ±10%	
C2	C48-1715-25	Polystyrene 1500pF ±5%	
C4,5	C24-1710-51	Electrolytic 1μF 50WV	
C6	C24-1047-61	Electrolytic 47μF 10WV	
C7	C24-1710-51	Electrolytic 1μF 50WV	
C8	C26-1210-67	Non-pole electrolytic 10μF 16WV	
C9	C24-1410-61	Electrolytic 10μF 25WV	
C10	C46-1710-35	Mylar 0.01μF ±5%	
C11~14	C47-1715-15	Polystyrene 150pF ±5%	
C15	C24-1047-61	Electrolytic 47μF 10WV	
C16	C46-1710-25	Mylar 1000pF ±5%	
C17	C46-1710-35	Mylar 0.01μF ±5%	
C18,19	C24-1410-61	Electrolytic 10μF 25WV	
C20	C24-1710-51	Electrolytic 1μF 50WV	
C21	C24-1410-61	Electrolytic 10μF 25WV	
C22,23	C46-1710-35	Mylar 0.01μF ±5%	
C24	C24-1410-61	Electrolytic 10μF 25WV	
C25	C25-1722-47	Electrolytic 0.22μF 50WV	
C26	C25-1747-47	Electrolytic 0.47μF 50WV	
C27	C27-1722-47	Electrolytic 0.22μF 50WV	
C28	C48-1710-15	Polystyrene 100pF ±5%	
C29	C46-1747-25	Mylar 4700pF ±5%	
C30	C71-1733-06	Ceramic 33pF ±10%	
C31,32	C46-1710-25	Mylar 1000pF ±5%	
C33	C46-1710-35	Mylar 0.01μF ±5%	
C34,35	C24-1047-61	Electrolytic 47μF 10WV	
C36	C26-1210-67	Non-pole electrolytic 10μF 16WV	
C37	C71-1733-06	Ceramic 33pF ±10%	

## PARTS LIST

Ref. No.	Parts No.	Description	Re- marks
C38	C26-1410-77	Non-pole electrolytic 100 $\mu$ F 25WV	
C39	C24-1710-51	Electrolytic 1 $\mu$ F 50WV	
C40	C46-1710-35	Mylar 0.01 $\mu$ F $\pm$ 5%	
C41~44	C24-1047-61	Electrolytic 47 $\mu$ F 10WV	
C45	C48-1710-25	Polystyrene 1000pF $\pm$ 5%	
C45~49	C24-1222-71	Electrolytic 220 $\mu$ F 16WV	
C50,51	C24-1410-61	Electrolytic 10 $\mu$ F 25WV	
<b>RESISTOR</b>			
R26	R43-1210-15	Flame-proof RD 100 $\Omega$ $\pm$ 5% 1/4W	
R39	R43-1210-15	Flame-proof RD 100 $\Omega$ $\pm$ 5% 1/4W	
R41	R43-1210-15	Flame-proof RD 100 $\Omega$ $\pm$ 5% 1/4W	
R47,48	R49-6239-23	Metal film 3.9k $\Omega$ $\pm$ 1% 1/4W	
R49,50	R49-6210-33	Metal film 10k $\Omega$ $\pm$ 1% 1/4W	
R51	R43-1210-15	Flame-proof RD 100 $\Omega$ $\pm$ 5% 1/4W	
R52,53	R49-6210-33	Metal film 10k $\Omega$ $\pm$ 1% 1/4W	
R57	R49-6210-33	Metal film 10k $\Omega$ $\pm$ 1% 1/4W	
R94	R48-2233-45	Metal film 330k $\Omega$ $\pm$ 5% 1/4W	
R95	R48-2210-45	Metal film 100k $\Omega$ $\pm$ 5% 1/4W	
R103	R49-6210-33	Metal film 10k $\Omega$ $\pm$ 1% 1/4W	
R104	R49-6233-23	Metal film 3.3k $\Omega$ $\pm$ 1% 1/4W	
R105	R49-6210-33	Metal film 10k $\Omega$ $\pm$ 1% 1/4W	
R109	R43-1210-15	Flame-proof RD 100 $\Omega$ $\pm$ 5% 1/4W	
R112,113	R43-1210-15	Flame-proof RD 100 $\Omega$ $\pm$ 5% 1/4W	
<b>SEMICONDUCTOR</b>			
Q1	V03-0409-05	Transistor 2SC1384(Q)	
Q2	V01-0143-05	Transistor 2SA684(Q)	
Q3	V03-0270-05	Transistor 2SC945(R,Q)	
Q4,5	V03-0098-05	Transistor 2SC535(B)	
Q6	V09-0096-05	FET 2SK68A(M)	
Q7	V03-1775-20	Transistor 2SC1775(E)	
Q8~11	V09-0096-05	FET 2SK68A(M)	
Q12	V01-0733-30	Transistor 2SA733A(R,Q)	
Q13	V03-1775-20	Transistor 2SC1775(E)	
Q14	V09-0110-05	FET 2SK68 (L,M)	
IC1	V30-0264-10	IC HA1457	
IC2,3	V30-0271-40	IC NJM4559D(F)	
IC4	V30-0301-70	IC TC4011BP	
IC5	V30-0248-10	IC NJM4558D(A)	
IC6	V30-0264-10	IC HA1457	
IC7	V30-0248-10	IC NJM4558D(A)	
IC8	V30-0264-10	IC HA1457	
IC9	V30-0268-10	IC MC1496K	
IC10	V30-0297-10	IC TC4069BP	
IC11,12	V30-0271-40	IC NJM4559D(F)	
IC13	V30-0160-05	IC HA1156W(B)	
IC14	V30-0264-10	IC HA1457	
D1,2	V11-0076-05	Diode 1S1555	
D3~7	V11-0319-05	Diode M8513A-0	
D8,9	V11-0076-05	Diode 1S1555	
DZ1,2	V11-7100-20	Zener diode EQA01-14	
DZ3	V11-7100-50	Zener diode EQA01-05(R)	
DZ4~7	V11-0431-05	Zener diode EQA01-06(S)	
<b>POTENTIOMETER</b>			
VR1	R12-1044-05	PC trimming 4.7k $\Omega$	
VR2,3	R12-1042-05	PC trimming 1k $\Omega$	
<b>FILTER</b>			
FL1	L79-0077-05	LC filter	
FL2	L79-0076-05	LC filter	

## SWITCH (X13-2620-00)

Ref. No.	Parts No.	Description	Re- marks
<b>CAPACITOR</b>			
C1~4	C55-1710-38	Ceramic 0.01 $\mu$ F +80% -20%	
C5	C81-1233-57	Tantalum 3.3 $\mu$ F 16WV	
C6	C55-1710-38	Ceramic 0.01 $\mu$ F +80% -20%	
<b>RESISTOR</b>			
R2	R40-8318-58	RC 1.8M $\Omega$ $\pm$ 20% 1/2W	
<b>SEMICONDUCTOR</b>			
Q1	V03-0297-05	Transistor 2SC945	
<b>COIL</b>			
L1,2	L33-0025-05	Choke coil 1 $\mu$ H	
<b>RELAY</b>			
RL1~3	S51-1020-05	Relay	

Two types of T meter are used in current tuners.

Parts No. of T meter	Serial No. of tuner
B31-0291-05	Less than 930001
B31-0291-15	From 930001

These two types of T meter cannot be interchanged, because their meter circuits are different. Use the correct type of T meter when replacing.

**SEMICONDUCTOR SUBSTITUTIONS**

PC Board Ass'y	Ref. No.	Semiconductor	Substitutions
X00-2020	Q1,3	2SD330 (E,F)	2SD313V-AI, $P_c \geq 20W$ , $I_c \geq 2A$ , $h_{FE} \geq 100$
	Q2,4	2SB514 (E,F)	2SB507V-AI, $P_c \geq 20W$ , $I_c \geq 2A$ , $h_{FE} \geq 100$
	Q5,8	2SC1735	2SC1940, $P_c \geq 0.8W$
	Q6	2SA850	2SC915, $P_c \geq 0.8W$
	Q7,9	2SC945 (R,Q)	2SC828A (P,Q), 2SC734, 2SC1213A, 2SC1775 (D,E), 2SC1890 (D,E,F)
X01-1290-11	Q1	CC3588DE	—
	Q2	2SK125	—
	Q3,4	2SC2408	—
	Q5	2SC1735 (E)	2SC1940 (K), $P_c \geq 0.75W$ , $P_c \geq 50mA$ , $h_{FE} \geq 150$
	Q6,7	2SC1384 (Q,R)	2SC1735 (D,E), $P_c \geq 0.75W$ , $P_c \geq 0.5A$ , $h_{FE} \geq 85$
X02-1150	Q1	2SK125	—
	Q2,4,6,12,13,15~18	2SC535 (B)	2SC381 (R,O)
	Q3,5,7~9,19~23	2SC945 (R,Q)	2SC828A (P,Q), 2SC1213A, 2SC1775 (D,E), 2SC1890 (D,E,F)
	Q10	2SK68 (M)	2SK105 (F,H), 2SK30A (Y,GR), 2SK68A (L,M)
	Q13	2SC2408	—
	Q14	2SK55 (E)	2SK19-GR
X02-1160-00	Q1~8,10	2SC535 (C)	2SC381 (R,O)
	Q9,11~14	2SA836 (E)	2SA872
	Q15	2SC1384 (Q,R)	2SC1885, $P_c \geq 0.75W$
	Q16	2SA733A (R,Q)	2SA872, 2SA564A
X04-1110	Q1~3,12,13,25	2SC945 (R,Q)	2SC828A (P,Q), 2SC734, 2SC1213A, 2SC1775 (D,E), 2SC1890 (D,E,F), $P_c \geq 250mW$ , $I_c \geq 50mA$ , $h_{FE} \geq 100$
	Q4	2SC1384 (Q,R)	2SC1567 (Q,R), $P_c \geq 0.75W$ , $I_c \geq 0.5A$ , $h_{FE} \geq 80$
	Q5,7~9,16	2SA733A (R,Q)	2SA893 (D,E)
	Q10,11	2SC945 (Q)	2SC828A (Q), 2SC1213A (C), $P_c \geq 250mW$ , $I_c \geq 50mA$ , $h_{FE} \geq 100$
	Q15,19,23	2SA872 (E)	2SA992 (E), $P_c \geq 250mW$ , $I_c \geq 50mA$ , $h_{FE} \geq 400$
	Q18,22	2SC1940 (K)	2SC1735 (D,E), $P_c \geq 0.75W$ , $I_c \geq 50mA$ , $h_{FE} \geq 90$
	Q20,24	2SA915 (K)	2SA850 (D,E), $P_c \geq 0.75W$ , $I_c \geq 50mA$ , $h_{FE} \geq 90$
X13-2600-00	Q1~8	2SC945 (R,Q)	2SC828A (P,Q), 2SC734, 2SC1213A, 2SC1775 (D,E), 2SC1890 (D,E,F)
	Q9~11	2SA733A (R,Q)	2SA872, 2SA564A
	Q12	2SK68 (M)	2SK105 (F,H), 2SK68A (L,M), 2SK30A (Y,GR)
X13-2610	Q1	2SC1384 (Q)	2SC1735 (D)
	Q2	2SA684 (Q)	—
	Q3	2SC945 (R,Q)	2SC828A (P,Q), 2SC1213A, 2SC1775 (D,E), 2SC1890 (D,E,F)
	Q4,5	2SC535 (B)	2SC381 (R,O)
	Q6,8~11	2SK68A (M)	2SK105 (H)
	Q7,13	2SC1775 (E)	2SC1980 (T,U), 2SC1775A, 2SC1890, 2SC1890A
	Q12	2SA733A (R,Q)	2SA564A (P,Q)
X13-2620-00	Q1	2SC945	2SC828, 2SC1775, 2SC1213, $P_c \geq 250mW$ , $I_c \geq 50mA$ , $h_{FE} \geq 90$