



**CONTENTS**

<b>1.</b>	<b>SAFETY INFORMATION</b>	.....1
1.1	PRELIMINARY	.....1
1.2	DURING USE	.....2
1.3	SYMBOLS	.....3
1.4	MAINTENANCE	.....4
<b>2.</b>	<b>DESCRIPTION</b>	.....5
2.1	NAMES OF COMPONENTS	.....5
2.2	SWITCH, BUTTONS AND INPUT JACK ELUCIDATION	.....6
<b>3.</b>	<b>SPECIFICATIONS</b>	.....7
3.1	GENERAL SPECIFICATIONS	.....7
3.2	ELECTRICAL SPECIFICATIONS	.....8
<b>4.</b>	<b>OPERATING INSTRUCTION</b>	.....13
4.1	POWER-UP	.....13
4.2	DATA HOLD	.....13
4.3	MAXIMUM HOLD	.....13
4.4	FUNCTION TRANSFORM	.....13
4.5	RANGE TRANSFORM	.....13
4.6	BACK LIGHT	.....14
4.7	AUTO POWER OFF	.....14
4.8	PREPARATION FOR MEASUREMENT	.....15
4.9	MEASURING DC VOLTAGE	.....15
4.10	MEASURING AC VOLTAGE	.....17
4.11	MEASURING DC CURRENT	.....18
4.12	DC CURRENT MEASURING (WITH CLAMP, OPTIONAL)	.....19
4.13	MEASURING AC CURRENT	.....20

---

4.14	AC CURRENT MEASURING (WITH CLAMP, OPTIONAL)	.....22
4.15	MEASURING RESISTANCE	.....23
4.16	MEASURING TEMPERATURE	.....24
4.17	MEASURING CAPACITANCE	.....25
4.18	DIODE TESTING	.....26
4.19	CONTINUITY TESTING	.....27
4.20	TRANSISTOR TESTING	.....28
<b>5.</b>	<b>MAINTENANCE</b>	.....29
5.1	BATTERY REPLACEMENT	.....29
5.2	FUSE REPLACEMENT	.....29
5.3	TEST LEADS REPLACEMENT	.....30
<b>6.</b>	<b>ACCESSORIES</b>	.....31

**1. SAFETY INFORMATION** **WARNING**

**To ensure safe operation, and in order to exploit to the full the functionality of the meter, please follow the directions in this section carefully.**

This multimeter has been designed according to IEC-61010-1 concerning electronic measuring instruments with an overvoltage category CAT III 600V and pollution 2.

Follow all safety and operating instructions to ensure that the meter is used safely and is kept in good operating condition.

With proper use and care, the digital meter will give you years of satisfactory service.

**1.1 PRELIMINARY**

1.1.1 When using the meter, the user must observe all normal safety rules concerning:

- Protection against the dangers of electrical current.
- Protection of the meter against misuse.

1.1.2 When the meter is delivered, check that it has not been damaged in transit.

1.1.3 When poor condition under harsh preservation or shipping conditions caused, inspect and confirm this meter without delay.

1.1.4 Test leads must be in good condition. Before using verify that the insulation on test leads is not damaged and/or the leads wire is not exposed.

1.1.5 Full compliance with safety standards can be guaranteed only if used with test leads supplied. If necessary, they must be replaced with the same model

or same electric ratings.

## **1.2 DURING USE**

- 1.2.1 Before using, you must select the right input jack, function and range.
- 1.2.2 Never exceed the protection limit values indicated in specifications for each range of measurement.
- 1.2.3 When the meter is linked to a measurement circuit, do not touch unused terminals.
- 1.2.4 At the manual range, when the value scale to be measured is unknown beforehand, set the range selector at the highest position.
- 1.2.5 Do not measure voltage if the voltage on the terminals exceeds 600V above earth ground.
- 1.2.6 Always be careful when working with voltages above 60V DC or 30V AC rms, keep fingers behind the probe barriers while measuring.
- 1.2.7 Never connect the meter leads across a voltage source while the transform switch is in the current, resistance, capacitance, temperature, diode, transistor or continuity mode. Doing so can damage the meter.
- 1.2.8 Before rotating the transform switch to change functions and ranges, disconnect test leads from the circuit under test.
- 1.2.9 Never perform resistance, capacitance, temperature, transistor, diode and continuity measurements on live circuits.
- 1.2.10 Never use the meter under the condition of the explosive air, steam or dirt.

- 1.2.11 If any faults or abnormalities are observed, the meter can not be used any more and it has to be checked out.
- 1.2.12 Never use the meter unless the rear case is in place and fastened fully.
- 1.2.13 Please do not store or use meter in areas exposed to direct sunlight, high temperature, humidity or condensation.

**1.3 SYMBOLS**

 Important safety information, refer to the operating manual.

 Double insulation (Protection class II) .

CAT III Overvoltage (Installation) category III, Pollution Degree 2 per IEC1010-1 refers to the level of Impulse Withstand Voltage protection provided.

 Conforms to european union directive

 Earth ground

 Fuse

**AC** Alternating current

**DC** Direct current

 Diode

 Continuity buzzer

 AC or DC (alternating current or direct current)

 Measurement with clamp (optional), widening the field of applications of the meter

°C Centigrade

°F Fahrenheit

**MAX.H** The maximum value is being held.

**DATA-H** This indicates that the display data is being held.

**AUTO** Auto range



The battery is not sufficient for proper operation.

## **1.4 MAINTENANCE**

1.4.1 Please do not attempt to adjust or repair the meter by removing the rear case while voltage is being applied.

A technician who fully understands danger involved should only carry out such actions.

1.4.2 Before opening the battery cover or case of the meter, always disconnect test leads from all tested circuits.

1.4.3 To avoid the wrong reading causing electricity attack, when the meter displays “

1.4.4 For continue protection against fire, replace fuse only with the specified voltage and current ratings: F 200mA/250V (quick acting).

1.4.5 Do not use abrasives or solvents on the meter, use a damp cloth and mild detergent only.



1.4.6 Always set the power switch to the OFF position when the meter is not in use.

1.4.7 If the meter is to be stored for a long period of time, the batteries should be removed to prevent damage to the unit.

**2. DESCRIPTION**

- This meter is a portable professional measuring instrument with handsome LCD and back light easily reading.
- Single operation of a transform switch makes measurement convenient. Overload protection and low battery indication are provided, this meter is ideal for use in the fields, workshop, school, hobby and home applications.
- This meter has function of auto range and manual range.
- This meter has function of auto power off.
- This meter is with the functions of data hold and maximum value hold.
- When using, it can show ranges engineering unit enunciators measuring results.

**2.1 NAMES OF COMPONENTS**

- (1) LCD Display
- (2) **ON/OFF** Button
- (3) **RANGE** Button
- (4) **FUNC.** Button
- (5) Transform Switch
- (6)  **10A** Jack
- (7) **INPUT** Jack
- (8) **COM** Jack
- (9) Panel
- (10)  Button
- (11) **DATA-H** Button
- (12) **MAX.H** Button

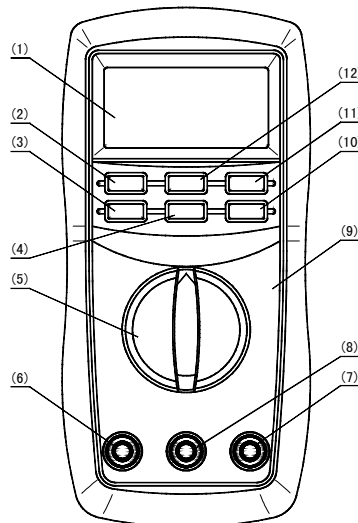



**2.2 SWITCH, BUTTONS AND INPUT JACK ELUCIDATION****• ON/OFF Button**

This Button is used to the switch of power.

**• RANGE Button**

This button is used to transform Auto range or manual range.

**• FUNC. Button**

This button is used to transform function.

**• DATA-H Button**

This Button is used to the switch of data hold.

**• MAX.H Button**

This Button is used to the switch of maximum value hold.

**•  Button**

This button is used to the switch of back light.

**• Transform Switch**

This switch is used to select functions and desired ranges.

**•  10A Jack**

Input terminal for current 0 ~ 10A

**• INPUT Jack**

Input terminals except 10A

**• COM Jack**

Common terminal for measurement

**3. SPECIFICATIONS**

Accuracy is specified for a period of year after calibration and at 18°C to 28°C (64°F to 82°F) with relative humidity to 75%.

**3.1 GENERAL SPECIFICATIONS**

- 3.1.1 Auto ranges and manual range.
- 3.1.2 Max. Voltage Between Terminals And Earth Ground: 600V DC or AC
- 3.1.3 Fuse Protection: F 200mA/250V (quick acting).
- 3.1.4 Operating Altitude: 2000 meters (7000 ft.) maximum
- 3.1.5 Display: 16mm LCD
- 3.1.6 Max. Show Value: 1999 (3 1/2)
- 3.1.7 Polarity Indication: '-' indicates negative polarity.
- 3.1.8 Overrange Indication: Display 'OL'
- 3.1.9 Sampling Time: approx. 0.4 second
- 3.1.10 Unit showing: showing of function and electrical capacity.
- 3.1.11 Low Battery Indication:  displayed
- 3.1.12 Auto power off time: 15 min.
- 3.1.13 Power Supply: 1.5V × 3 AAA battery.
- 3.1.14 Operating Temperature: 0°C to 40°C (32°F to 104°F)
- 3.1.15 Storage Temperature: -10°C to 50°C (10°F to 122°F)
- 3.1.16 Dimension: 158 × 74 × 32 mm
- 3.1.17 Weight: approx. 250g (including battery)

**3.2 ELECTRICAL SPECIFICATIONS**

Circumstance Temperature:  $23\pm 5^{\circ}\text{C}$

Relative Humidity: < 75%

**3.2.1 DC Voltage**

Range	Resolution	Accuracy
200mV	0.1mV	$\pm (0.7\% \text{ of rdg} + 2 \text{ digits})$
2V	0.001V	
20V	0.01V	
200V	0.1V	
600V	1V	

- Input Impedance:  $10\text{M}\Omega$
- Overload Protection: 200mV range: 250V DC or AC rms, 2V-600V ranges: 600V DC or AC rms.
- Max. Input Voltage: 600V DC

**3.2.2 AC Voltage**

Range	Resolution	Accuracy
200mV	0.1mV	$\pm (0.8\% \text{ of rdg} + 3 \text{ digits})$
2V	0.001V	
20V	0.01V	
200V	0.1V	
600V	1V	$\pm (1.0\% \text{ of rdg} + 3 \text{ digits})$

- Input Impedance:  $10\text{M}\Omega$
- Overload Protection: 200mV range: 250V DC or AC rms, 2V-600V ranges: 600V DC or AC rms.
- Frequency Range: 40 to 400Hz
- Response: Average, calibrated in rms of sine wave.
- Max. Input Voltage: 600V AC rms

- 8 -

**3.2.3 DC Current**

Range	Resolution	Accuracy
200 $\mu$ A	0.1 $\mu$ A	$\pm$ (1.2% of rdg + 3 digits)
2000 $\mu$ A	1 $\mu$ A	
20.00mA	0.01mA	
200.0mA	0.1mA	
2.000A	0.001A	$\pm$ (2.0% of rdg + 10 digits)
10.00A	0.01A	

- Overload Protection:  $\mu$  A, mA ranges: F 200mA/250V fuse (quick acting), 2A, 10A range: unfused.
- Max. Input Current: INPUT Jack: 200mA, 10A Jack: 10A
- Voltage Drop: 200 $\mu$ A, 20mA, 2A: 20mV,  
2000 $\mu$ A, 200mA, 10A range: 200mV





**3.2.4 AC Current**

Range	Resolution	Accuracy
200 $\mu$ A	0.1 $\mu$ A	$\pm$ (1.5% of rdg + 5 digits)
2000 $\mu$ A	1 $\mu$ A	
20.00mA	0.01mA	
200.0mA	0.1mA	
2.000A	0.001A	$\pm$ (3.0% of rdg + 10 digits)
10.00A	0.01A	

- Overload Protection:  $\mu$  A, mA ranges: F 200mA/250V fuse (quick acting), 2A, 10A range: unfused.
- Max. Input Current: INPUT Jack: 200mA, 10A Jack: 10A
- Frequency Range: 40 to 400Hz
- Response: Average, calibrated in rms of sine wave.





- Voltage Drop: 200μA、20mA、2A: 20mV,  
2000μA、200mA、10A range: 200mV

**3.2.5 DC Current (with clamp, optional)**

	Range	Resolution	Accuracy
meter	 200A	0.1mV/0.1A	±(1.2 % of rdg + 3 digits)
DC Clamp	 0 to 200A	0.1A /0.1mV	Typical ± (2.0 %)
meter	 2000A	1mV/1A	±(1.2 % of rdg + 3 digits)
DC Clamp	 0 to 2000A	1A/1mV	Typical ± (2.0 %)

- Overload Protection: 250V DC or AC rms
- Max. Input Voltage: 200mV

**3.2.6 AC Current (with clamp, optional)**

	Range	Resolution	Accuracy
meter	 200A	0.1mV/0.1A	± (1.5 % of rdg + 5digits)
AC Clamp	 0 to 200A	0.1A/0.1mV	Typical ± (3.0 %)
meter	 2000A	1mV/1A	±(1.5 % of rdg + 5 digits)
AC Clamp	 0 to 2000A	1A/1mV	Typical ± (3.0 %)

- Overload Protection: 250V DC or AC rms
- Max. Input Voltage: 200mV
- Frequency Range: 40 to 400Hz
- Response: Average, calibrated in rms of sine wave.

**3.2.7 Continuity**

Range	Function
	Built-in buzzer will sound, if resistance is lower than 50Ω.

## DIGITAL MULTIMETER

## SPECIFICATIONS

- Open circuit voltage: approx. 0.5V
- Overload Protection: 250V DC or AC rms

### 3.2.8 Resistance

Range	Resolution	Accuracy
200 $\Omega$	0.1 $\Omega$	$\pm$ (1.0% of rdg + 3 digits)
2k $\Omega$	0.001k $\Omega$	$\pm$ (1.0% of rdg + 1 digit)
20k $\Omega$	0.01k $\Omega$	
200k $\Omega$	0.1k $\Omega$	
2M $\Omega$	0.001M $\Omega$	
20M $\Omega$	0.01M $\Omega$	$\pm$ (1.0% of rdg + 5 digits)

- Open Circuit Voltage: 0.25V
- Overload Protection: 250V DC or AC rms

### 3.2.9 Temperature

Range	-20 $^{\circ}$ C to 1000 $^{\circ}$ C	
Resolution	1 $^{\circ}$ C	
Accuracy	-20 $^{\circ}$ C to 0 $^{\circ}$ C	$\pm$ (5% of rdg + 4digits)
	0 $^{\circ}$ C to 400 $^{\circ}$ C	$\pm$ (1% of rdg + 3digits)
	400 $^{\circ}$ C to 1000 $^{\circ}$ C	$\pm$ (2% of rdg + 3digits)
Range	0 $^{\circ}$ F to 1800 $^{\circ}$ F	
Resolution	1 $^{\circ}$ F	
Accuracy	0 $^{\circ}$ F to 50 $^{\circ}$ F	$\pm$ (5% of rdg + 4digits)
	50 $^{\circ}$ F to 750 $^{\circ}$ F	$\pm$ (1% of rdg + 3digits)
	750 $^{\circ}$ F to 1800 $^{\circ}$ F	$\pm$ (2% of rdg + 3digits)

- Overload Protection: 250V DC or AC rms

**3.2.10 Capacitance**

Range	Resolution	Accuracy
20nF	0.01nF	$\pm (4.0\% \text{ of rdg} + 10\text{digits})$
200nF	0.1nF	$\pm (4.0\% \text{ of rdg} + 3 \text{ digits})$
2 $\mu$ F	0.001 $\mu$ F	
20 $\mu$ F	0.01 $\mu$ F	
200 $\mu$ F	0.1 $\mu$ F	
1000 $\mu$ F	1 $\mu$ F	

- Overload Protection:

20nF~20 $\mu$ F ranges: F 200mA/250V fuse (quick acting).

200 $\mu$ F/1000 $\mu$ F ranges: No Overload Protection.

- Open circuit voltage: approx. 0.5V

- Overload Protection: 250V DC or AC rms

**3.2.11 Diode**

Range	Resolution	Function
	1mV	Display :read approximate forward voltage of diode

- Forward DC Current: approx. 1mA

- Reversed DC Voltage: approx.1.5V

- Overload Protection: 250V DC or AC rms

**3.2.12 Transistor hFE**

Range	Function
hFE	Display: read approximate hFE value (0-1000) of transistor under test (ALL TYPE)

- Base Current: approx. 2 $\mu$ A, Vce: approx. 1V

- Overload Protection: F 200mA/250V fuse (quick acting)

**4. OPERATING INSTRUCTION****4.1 POWER-UP**

Press the '**ON/OFF**' button to turn the meter ON or OFF.

**4.2 DATA HOLD**

If you need data hold when measuring, you can put on '**DATA-H**' button, it will hold the reading; if you put the button again, data hold is not continue.

**4.3 MAXIMUM VALUE HOLD**

If you need data hold when measuring, you can put on '**MAX.H**' button, it will hold the maximum value; if you put the button again, maximum value hold is not continue.

**4.4 FUNCTION TRANSFORM**

Put down the '**FUNC.**' when measuring the current and voltage. Meter will be transformed between DC and AC range. Put '**FUNC.**' when measuring the temperature, meter will transform between °C and °F range. Put '**FUNC.**' when measuring the diode and continuity, meter will transform among them.

**4.5 RANGE TRANSFORM**



The auto range is used when measuring the current, voltage, capacitance and resistance. Put down the '**RANGE**' if the manual range is needed. Each time you put down, range will go upward; the minimum range is transformed if '**RANGE**' is put down at the maximum range. If the '**RANGE**' is put down more than two seconds, auto range is used again.





#### 4.6 BACK LIGHT

If the light is dark to make the reading difficult when measuring, you can press '  ' button to turn on the back light, which will last for 15 seconds. Continuous pressing the button for two seconds will turn off the back light.

#### **NOTE:**

- LED is the main source of back light. Its working current is large, although the meter has the timer equipment (time is 15 seconds and it will off automatically after 15 seconds); often use back light will shorten the battery life, you'd better not to use the back light so frequently if it's not necessary.
- When the battery voltage is less than 4V, it will show '  '. But if you use back light at the same time, maybe '  ' will come up even if the battery voltage is more than 4V, because the working current is higher and the voltage will decline. (When '  ' shows, the accuracy of the measurement can not be assured.)

You need not replace the battery. When you use normally (back light is not using), '  ' will not show up. You need replace it till '  ' show again.

#### 4.7 AUTO POWER OFF

If there's no any operation within fifteen minutes after power is on, meter will auto power off with five short sounds and a long sound in a minute.

After auto power off, if stir the transform switch or put down any button of 'FUNC.', 'DATA-H', 'MAX.H', 'RANGE', meter

will recover the working condition.

If presses the '**FUNC.**' when power is on, auto power off disable.

#### **4.8 PREPARATION FOR MEASUREMENT**

4.8.1 Put on the '**ON/OFF**' button. If the battery voltage is less than 3.8V, display will show '' , the battery should be changed at this time.

4.8.2 The '' besides the input jack shows that the input voltage or current should be less than specification on the sticker of the meter to protect the inner circuit from damaging.

4.8.3 Select a function and a range for the item to be measured through rotating the transform switch accordingly. When the value scale to be measured is unknown beforehand, set the range selector at the highest position.

4.8.4 When connection, first connect to the public testing line, then to the electriferous testing line. When you'll remove it, you should remove the elecriciferous one.

#### **4.9 MEASURING DC VOLTAGE**

##### **WARNING**

**You can't input the voltage which more than 600V DC, it's possible to show higher voltage, but it's may destroy the inner circuit.**

**Pay attention not to get an electric shock when measuring high voltage.**

4.9.1 Connect the black test lead to the **COM** jack and the red test lead to the **INPUT** jack.

4.9.2 Set the transform switch at the V range position.

4.9.3 Put down the '**FUNC.**' to enter the DC measurement. Auto range or manual range can be transformed by putting the '**RANGE**'.

4.9.4 Connect test leads across the source or load under measurement.

4.9.5 You can get a reading from LCD display. The polarity of the red test lead connection will be indicated.

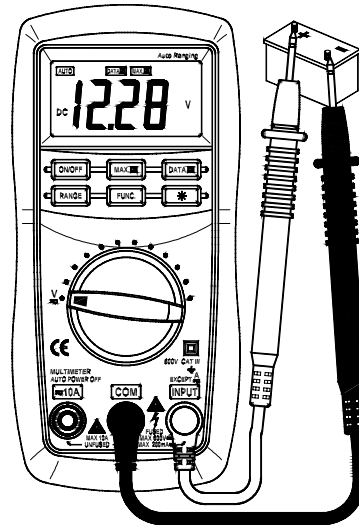

#### NOTE:

- At the little voltage range, the meter will show unsteady reading when test leads haven't reach the circuit, it's normal because the meter is very sensitivity. When test leads touch the circuit, you can get the true reading.
- At the manual range mode, when only the figure 'OL' is displayed, it indicates overrange situation and the higher range has to be selected.
- At the manual range mode, when the value scale to be measured is unknown beforehand, set the range selector at the highest position.

**4.10 MEASURING AC VOLTAGE****⚠ WARNING**

You can't input the voltage which more than 600V rms AC, it's possible to show higher voltage, but it's may destroy the inner circuit.

Pay attention not to get an electric shock when measuring voltage.

4.10.1 Connect the black test lead to the **COM** jack and the red test lead to the **INPUT** jack.

4.10.2 Set the transform switch at the V range position.

4.10.3 Put down the '**FUNC.**' to enter the AC measurement. Auto range or manual range can be transformed by putting the '**RANGE**'.

4.10.4 Connect test leads across the source or load under measurement.

4.10.5 You can get reading from LCD.

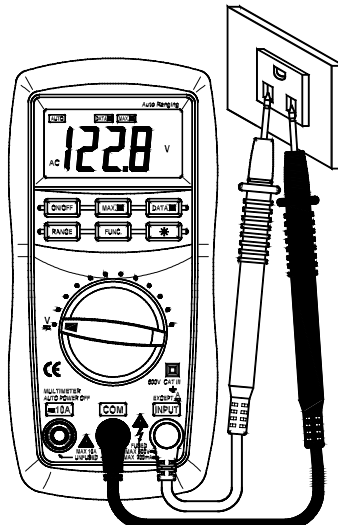
**NOTE:**

- At the little voltage range, the meter will show unsteady reading when test leads haven't reach the circuit, it's normal because the meter is very sensitivity. When test leads touch the circuit, you can get the true reading.
- At the manual range mode, when only the figure 'OL' is displayed, it indicates overrange situation and the higher range has to be selected.

- At the manual range mode, when the value scale to be measured is unknown beforehand, set the range selector at the highest position.

### 4.11 MEASURING DC CURRENT

#### WARNING

Shut down the power of the tested circuit, then connect the meter with the circuit for measurement.

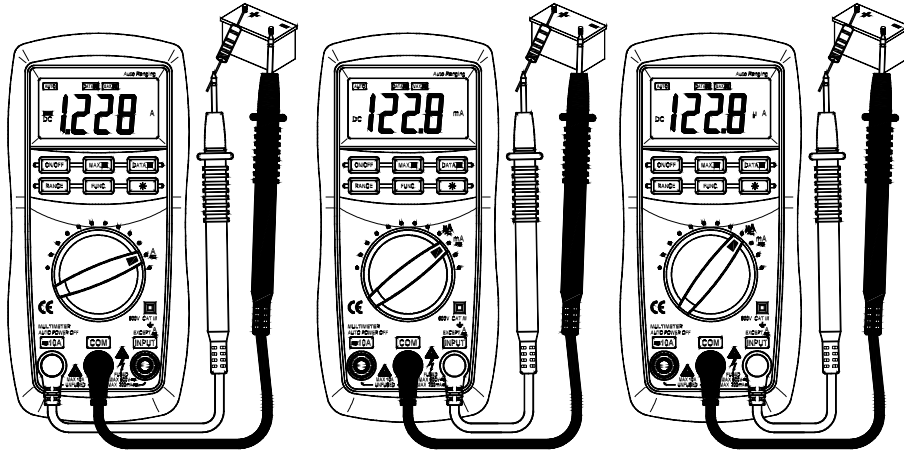

- 4.11.1 Connect the black test lead to the **COM** jack and the red test lead to the **INPUT** jack for a maximum of 200mA current. For a maximum of 10A, move the red lead to the **10A** jack.
- 4.11.2 Set the transform switch at the desired  $\mu$  A, mA or A range position.
- 4.11.3 Put down the '**FUNC.**' to enter the DC measurement. Auto range or manual range can be transformed by putting the '**RANGE**'.
- 4.11.4 Connect test leads in series with the load under measurement.

4.11.5 You can get reading from LCD. The polarity of red test lead will be indicated.

### NOTE:

- When only the figure 'OL' is displayed, it indicates overrange situation and the higher range has to be selected.
- When the value scale to be measured is unknown beforehand, set the range selector at the highest position.
- '⚠' means the socket of **INPUT** maximum current is 200mA, over current will destroy the fuse. **10A**'s maximum current is 10A, no fuse protection.

### 4.12 MEASURING AC CURRENT

#### ⚠ WARNING

Shut down the power of the tested circuit, then connect the meter with the circuit for measurement.

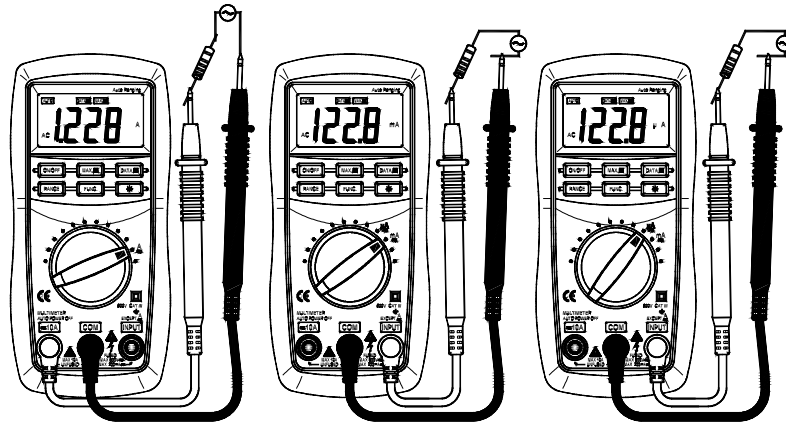

4.12.1 Connect the black test lead to the **COM** jack and the red test lead to the **INPUT** jack for a maximum of 200mA current. For a maximum of 10A, move the red lead to

the **10A** jack.

4.12.2 Set the transform switch at the desired  $\mu$  A, mA or A range position.

4.12.3 Put down the '**FUNC.**' to enter the AC measurement. Auto range or manual range can be transformed by putting the '**RANGE**'.

4.12.4 Connect test leads in series with the load under measurement.

4.12.5 You can get reading from LCD.

**NOTE:**

- When only the figure 'OL' is displayed, it indicates overrange situation and the higher range has to be selected.
- When the value scale to be measured is unknown beforehand, set the range selector at the highest position.
- ' $\triangle$ ' means the socket of **INPUT** maximum current is 200mA, over current will destroy the fuse. **10A**'s maximum current is 10A, no fuse protection.

**4.13 DC CURRENT MEASURING**

(WITH CLAMP, OPTIONAL)

4.13.1 Connect the black output lead of clamp to the **COM** jack and the red one to the **INPUT** jack of the meter.

4.13.2 Set the transform switch at the  range position.

4.13.3 Put down the '**FUNC.**' to enter the DC measurement. Auto range or manual range

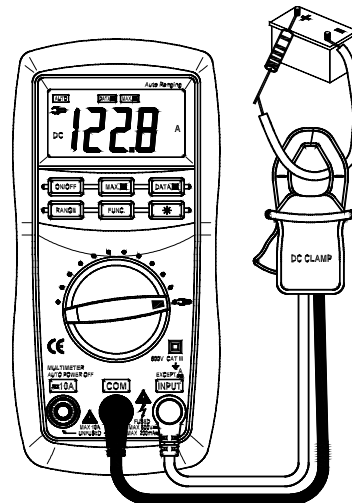

can be transformed by putting the '**RANGE**'.

4.13.4 Clamp the circuit under measured.

4.13.5 You can get reading from LCD. The polarity of red output lead will be indicated.

**NOTE:**

- Select the DC clamp to measure the DC current.
- At the manual range mode, when only the figure 'OL' is displayed, it indicates overrange situation and the higher range has to be selected.
- At the manual range mode, when the value scale to be measured is unknown beforehand, set the range selector at the highest position.
- Matching problem about the meter and the sensitivity of the clamp:
  - a. The sensitivity of 200A range is 200mV, that of 2000A is 2V; the sensitivity of the matching clamp is 0.1A/0.1mV. The present indicated value is same to the measured value.
  - b. If the sensitivity of the selected clamp is low (0.1A/0.01mV), the indicated value will be 10 times lower than the measured value. For example, the measured current is 100A, then the indicated value will be 10.0A.
  - c. If the sensitivity of the selected clamp is high (0.1A/1mV), the indicated value will be 10 times higher than the measured value. For example, the measured current is 10A, then the indicated value will be 100.0A.



**4.14 AC CURRENT MEASURING (WITH CLAMP, OPTIONAL)**

4.14.1 Connect the black output lead of clamp to the **COM** jack and the red one to the **INPUT** jack of the meter.

4.14.2 Set the transform switch at the  range position.

4.14.3 Put down the '**FUNC.**' to enter the AC measurement. Auto range or manual range can be transformed by putting the '**RANGE**'.

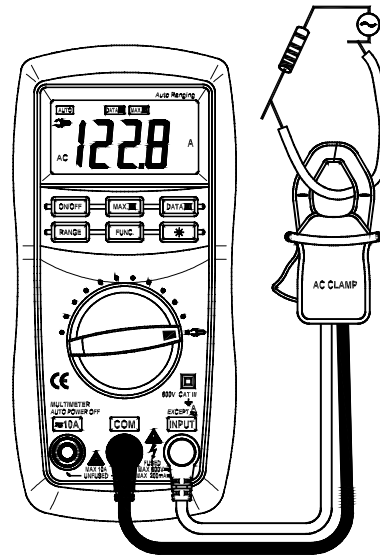

4.14.4 Clamp the circuit under measured.

4.14.5 You can get reading from LCD.

**NOTE:**

- Select the AC clamp to measure the AC current.
- At the manual range mode, when only the figure 'OL' is displayed, it indicates overrange situation and the higher range has to be selected.
- At the manual range mode, when the value scale to be measured is unknown beforehand, set the range selector at the highest position.
- Matching problem about the meter and the sensitivity of the clamp:
  - a. The sensitivity of 200A range is 200mV, that of 2000A is 2V; the sensitivity of the matching clamp is 0.1A/0.1mV. The present indicated value is same to the

measured value.

- b. If the sensitivity of the selected clamp is low (0.1A/0.01mV), the indicated value will be 10 times lower than the measured value. For example, the measured current is 100A, then the indicated value will be 10.0A.
- c. If the sensitivity of the selected clamp is high(0.1A/1mV), the indicated value will be 10 times higher than the measured value. For example, the measured current is 10A, then the indicated value will be 100.0A.

### 4.15 MEASURING RESISTANCE

#### WARNING

When measuring in-circuit resistance, be sure the circuit under test has all power removed and that all capacitors have been discharged fully.

4.15.1 Connect the black test lead to the **COM** jack and the red test lead to the **INPUT** jack.

4.15.2 Set the transform switch at the  $\Omega$  range position. Auto range or manual range can be transformed by putting the '**RANGE**'.

4.15.3 Connect test leads across the resistance under measurement.

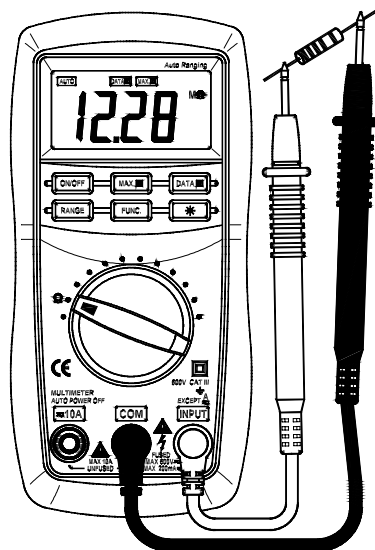

4.15.4 You can get reading from LCD.

### NOTE:

- At the manual range mode, when only the figure 'OL' is displayed, it indicates overrange situation and the higher range has to be selected.
- For measuring resistance above  $1M\Omega$ , the meter may take a few seconds to get stable reading.
- When the input is not connected, i.e. at open circuit, the figure 'OL' will be displayed for the overrange condition.

### 4.16 MEASURING TEMPERATURE

#### WARNING

To avoid electrical shock, do not connect the thermocouples with the electriferous circuit.

4.16.1 Set the transform switch at the TEMP range position.

4.16.2  $^{\circ}C$  range or  $^{\circ}F$  range can be transformed by putting the 'FUNC.'.

4.16.3 The LCD display will show the current environment temperature.

4.16.4 When measuring the temperature with thermocouple, 'K' type probe for this meter can be used. Insert the black plug to the **COM** jack and the red one to the **INPUT** jack, touch the end of the temperature sensor to the area or surface of the object

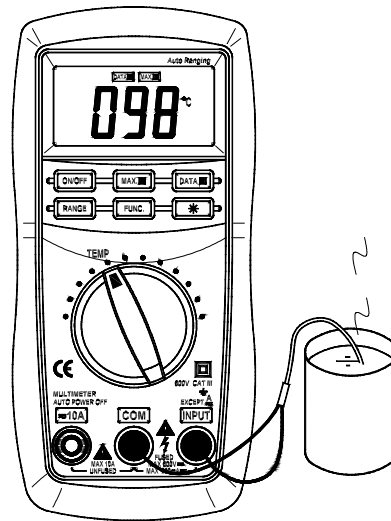

for measurement.

4.16.5 You can get reading from LCD.

### NOTE:

- With better hermetization, the meter's temperature measured circuit and environment need a little longer time to reach heat balance, and then accurate reading can be gotten.

### 4.17 MEASURING CAPACITANCE

#### ⚠ WARNING

To avoid electric shock, be sure the capacitors have been discharged fully before measuring the capacitance of a capacitor.

4.17.1 Connect the black test lead to the **COM** jack and the red test lead to the **INPUT** jack.

4.17.2 Set the transform switch at the desired nF, 20  $\mu$  F or 2000  $\mu$  F range position.

4.17.3 Auto range or manual range can be transformed by putting the '**RANGE**'.

4.17.4 Before connect test leads across two sides of the capacitor under measurement, be sure that the capacitor has been

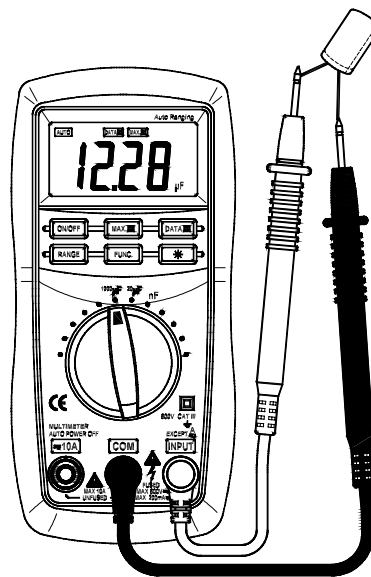

discharged fully.

4.17.5 You can get reading from LCD.

4.17.6 When frequent capacitor testing is needed, put the plug of multifunction test socket into **COM** and **INPUT** and put the capacitor foot into two long socket of capacitor testing equipment, capacitor testing is ready.

**NOTE:**

- At the small capacitor range, the reading will include the small value because some influence from the distribution of test leads. It will not influence the accuracy of measuring.

**4.18 TESTING DIODE**

4.18.1 Connect the black test lead to the **COM** jack and the red test lead to the **INPUT** jack. (The polarity of red lead is '+')

4.18.2 Set the transform switch at the  $\rightarrow+$  range position.

4.18.3 put down the '**FUNC.**' transformed at  $\rightarrow+$  test.

4.18.4 Connect the red lead to the anode, the black lead to the cathode of the diode under testing.

4.18.5 You can get reading from LCD.

**NOTE:**

- The meter will show the approximate forward voltage drop of the diode.

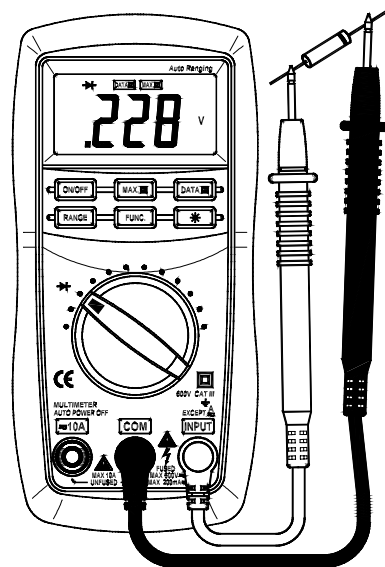

- If the lead connection is reversed, only figure 'OL' will be displayed.
- When the input is not connected, i.e. at open circuit, the figure 'OL' will be displayed.

### 4.19 TESTING CONTINUITY

#### WARNING

When testing the circuit continuity, be sure that the power of the circuit has been shut down and all capacitors have been discharged fully.

4.19.1 Connect the black test lead to the **COM** jack and the red test lead to the **INPUT** jack.

4.19.2 Set the transform switch at the  $\bullet \text{||}$  range position.

4.19.3 put down the '**FUNC.**' transformed at  $\bullet \text{||}$  continuity test.

4.19.4 Connect test leads across two points of the circuit under testing.

4.19.5 If continuity exists ( i.e., resistance less than about  $50\Omega$  ) , built-in buzzer will sound.

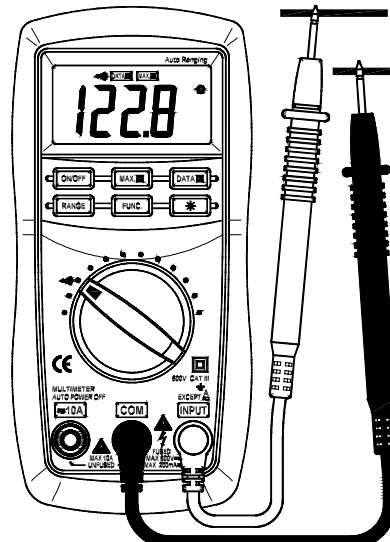

#### NOTE:

- If the input open circuit (or the circuit resistance measured is higher than  $200\Omega$ ), then the figure 'OL' will be displayed.

**4.20 TESTING TRANSISTOR**

4.20.1 Set the transform switch at the hFE range position.

4.20.2 Put two plugs '-' and '+' of multifunction test socket into **COM** jack and **INPUT** jack respectively.

4.20.3 Identify whether the transistor is NPN or PNP type and insert emitter, base and collector leads into the proper holes of the transistor on the multifunction test socket for testing.

4.20.4 You can get reading from LCD.

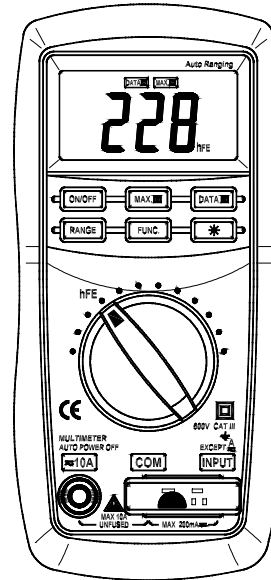
**NOTE:**

- Do not put the plug into the wrong jack.

**5. MAINTENANCE****5.1 BATTERY REPLACEMENT** **WARNING**

**Before attempting open the battery cover of the meter, be sure that test leads have been disconnected from measurement circuit to avoid electric shock hazard.**

- 5.1.1 If the sign ‘’, appears on the LCD display, it indicates that the battery should be replaced.
- 5.1.2 Loosen the screw fixing the battery cover and remove it.
- 5.1.3 Replace the exhausted battery with a new one.
- 5.1.4 Put the battery cover as its origin.

**5.2 FUSE REPLACEMENT** **WARNING**

**Before attempting open the battery cover of the meter, be sure that test leads have been disconnected from measurement circuit to avoid electric shock hazard.**

**For protection against fire, replace fuses only with specified ratings: F 200mA/250V (quick acting).**

- 5.2.1 Fuse rarely need replacement and blow almost always as a result of the operator’s error.
- 5.2.2 Loosen the fixing screw of the case and remove it.
- 5.2.3 Replace the blown fuse with ratings specified.
- 5.2.4 Put the case as its origin.



**5.3 TEST LEADS REPLACEMENT**

 **WARNING**

**Full in compliance with safety standards can be guaranteed only if used with test leads supplied. If necessary, they must be replaced with the same model or same electric ratings. Electric ratings of the test leads: 600V 10A.**

You must be replaced the test leads if the lead is exposed.

**6. ACCESSORIES**

- |     |                                       |              |
|-----|---------------------------------------|--------------|
| (1) | Test Leads: Electric Ratings 600V 10A | one piece    |
| (2) | Battery:1.5V, AAA                     | three pieces |
| (3) | Operating Manual                      | one piece    |
| (4) | Thermocouple (K type)                 | one piece    |
| (5) | Multifunction test socket             | one piece    |

