

ST-S770ES

SERVICE MANUAL

AEP Model
UK Model

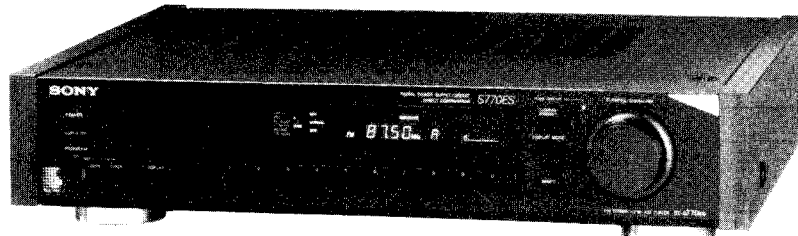

SPECIFICATIONS

General

Circuit System	FM stereo, FM/AM super-heterodyne tuner PLL quartz-locked digital synthesizer system	Dimension	UK model Approx. 430 x 95 x 372 mm (w/h/d) (17 x 3-3/4 x 14-3/4 inches) Other models Approx. 470 x 96 x 372 mm (w/h/d) (18-5/8 x 3-7/8 x 14-3/4 inches)
Power requirements	UK model: 240 V AC (or 220 V AC adjustable by authorized Sony personnel), 50/60 Hz Other models: 220-230 V AC (or 240 V AC adjustable by authorized Sony personnel), 50/60 Hz	Weight	UK model Approx. 5.8 kg (12 lb 13 oz) Other models Approx. 6.4 kg (14 lb 2 oz)
Power consumption	20 watts	Accessories Supplied	Connecting Cord (1) FM ribbon antenna (1) AM loop antenna (1) Antenna connector (1) Remote control cord (4-pin) (1) Short screw (M4 x 8) (4) (for models other than UK model)



FM STEREO / FM-AM TUNER
SONY®

FM tuner		
Tuning range		87.5-108 MHz
Intermediate frequency		10.7 MHz
Sensitivity	mono S/N 26 dB	10.3 dBf, 0.9 μ V/75 ohms
	stereo S/N 46 dB	38.5 dBf, 23 μ V/75 ohms
Usable sensitivity		10.3 dBf, 0.9 μ V/75 ohms (IHF)
Signal-to noise ratio	at 40 kHz deviation	95 dB (mono) 86 dB (stereo)
	Harmonic distortion	WIDE 0.008% (mono) 0.02% (stereo) NARROW 0.04% (mono) 0.08% (stereo)
Separation at 1 kHz		65 dB
Selectivity	at 400 kHz	WIDE 80 dB
		NARROW 90 dB
	at 300 kHz	WIDE 45 dB
		NARROW 70 dB
Output	at 40 kHz deviation	400 mV

AM tuner		
Tuning range		AEP, UK, Germany models MW: 531-1602 kHz (9 kHz step) LW: 153-279 kHz (1 kHz step) Italian model MW: 522-1611 kHz (9 kHz step) LW: 144-288 kHz (1 kHz step)
Intermediate frequency		450 kHz
Usable sensitivity		
MW	AM loop antenna	250 μ V/m
	External antenna	30 μ V/m
LW	AM loop antenna	700 μ V/m
	External antenna	200 μ V/m
Signal-to-noise ratio		54 dB
Harmonic distortion		0.3 %
Selectivity		at 9 kHz: 65 dB (NARROW) 50 dB (WIDE)

- MODEL IDENTIFICATION -
(Specification Label)

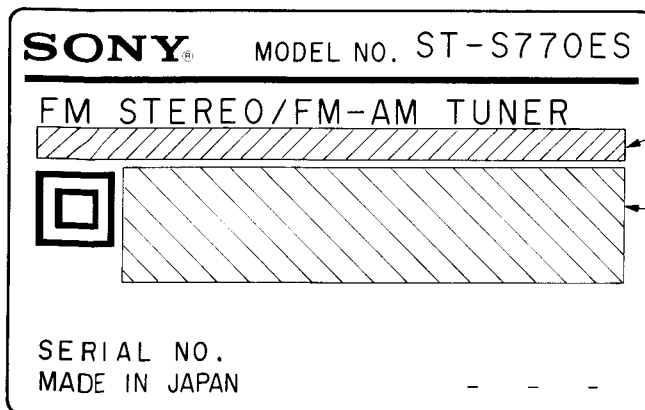

IT model : AC 220-230V ~ 50/60Hz
 AEP model : AC 220-230V ~ 50/60Hz
 G model : AC 220-230V ~ 50/60Hz
 UK model : AC 240V ~ 50/60Hz

AEP model :

G model :

IT, UK model : No Printed

TABLE OF CONTENTS

<u>Section</u>	<u>Title</u>	<u>Page</u>
Specifications.....		1
Features.....		3
1. GENERAL		
1-1.	Location and Function of Controls	4
1-2.	Broadcast Reception	5
1-2-1.	Tuning in Manually	5
1-2-2.	Tuning in Automatically	5
1-2-3.	Storing station frequency into memory	6
1-2-4.	Receiving a Stored Station	6
1-2-5.	Scanning Stored Stations Automatically	7
1-2-6.	Scanning Stored Stations Manually	7
2. IC PIN FUNCTIONS		
2-1.	IC601 (μ PD75108CW-A76) Pin Functions	8
3. BLOCK DIAGRAM		11
4. ELECTRICAL ADJUSTMENTS		13
5. DIAGRAMS		
5-1.	Printed Wiring Boards	17
5-2.	Schematic Diagram	21
5-3.	Schematic on Waveforms	24
5-4.	IC Block Diagram	24
5-5.	Semiconductor Lead Layouts	26
6. EXPLODED VIEWS		
6-1.	CABINET ASSEMBLY	27
6-1.	CHASSIS ASSEMBLY	29
7. ELECTRICAL PARTS LIST		31

• **Note:**

G: Germany model
IT: Italian model

Features

Precise Tuning with the large knob

The detected revolution of the tuning knob is under digital-control so that you can tune in the correct frequency and stored station easily.

This system employs a variable muting function that adjusts itself to the rotation speed of the TUNING knob and changes the muting time. This function realizes a feeling which is very close to that of an analog type tuner.

Direct comparator technology

An employed PLL IC allows the comparison frequency to be as high as the channel spacing frequency, thus eliminating the tendency of a low comparison frequency to slip into the audio range and degrade the signal-to-noise ratio.

Free from digital noise

When the tuning completes, the clock oscillator of the micro-computer stops. Since the received signal passes through only analog circuits, you can enjoy the pure sound without an interference.

Wave optimizer technology

The WOIS (Wave Optimized IF System) which makes the IF waveform optimum shape in stereo and monaural mode and the WODD (Wave Optimized Direct Detector) which forms the VCO oscillation waveform of the PLL detector ensure low distortion sound.

Program function

Using the program function, you can automatically tune in up to four stations which have been memorized in any sequence you want. Stations will be received one by one as the power is turned on and off by an optional audio timer.

SAFETY-RELATED COMPONENT WARNING!!

COMPONENTS IDENTIFIED BY MARK \triangle OR DOTTED LINE WITH MARK \triangle ON THE SCHEMATIC DIAGRAMS AND IN THE PARTS LIST ARE CRITICAL TO SAFE OPERATION. REPLACE THESE COMPONENTS WITH SONY PARTS WHOSE PART NUMBERS APPEAR AS SHOWN IN THIS MANUAL OR IN SUPPLEMENTS PUBLISHED BY SONY.

SECTION 1 GENERAL

This section is extracted from instruction manual.

1-1. LOCATION AND FUNCTION OF CONTROLS

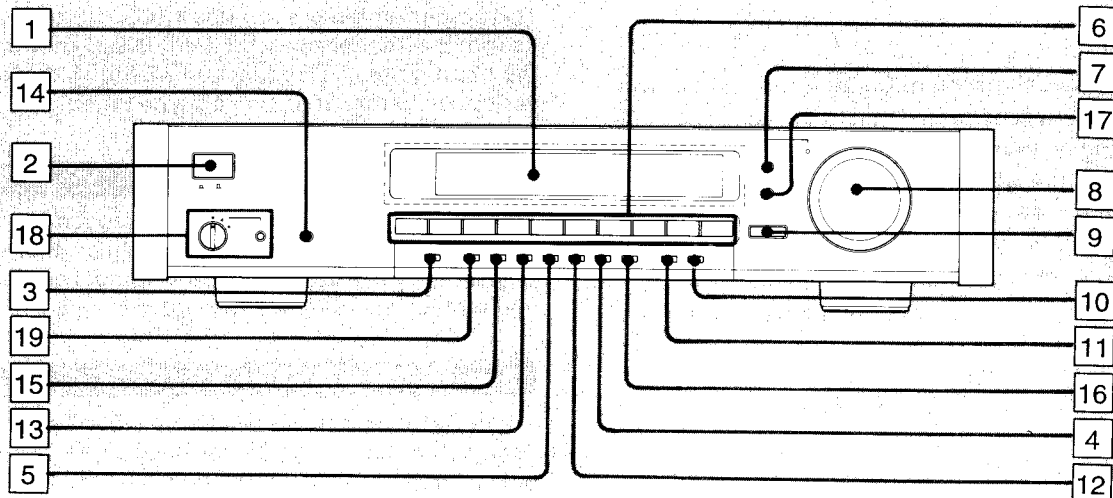

- 1** Display window
2 POWER switch
3 CAL TONE (calibrating tone) button
 Press this button to obtain a 400 Hz, 50% modulated signal for adjusting the recording level on a cassette deck. "CAL" will appear when a 400 Hz calibrating tone signal is provided. To deactivate the calibrating tone circuit, press the button again.
4 TUNE MODE (tuning mode) button
5 MUTING button
6 PRESET buttons
7 TUNING/PRESET button
8 TUNING/CHARACTER knob
9 SHIFT button
10 MEMORY button
11 Band selector
12 FM MODE button
Auto Stereo: Normally, select this mode (by making the HI-BLEND and MONO indicators disappear from the display window) when you tune in a strong FM broadcast.
HI-BLEND: Select this position when the high-frequency sound is noisy in the FM band. The high-frequency noise will be reduced, but this lowers the stereo effect.
MONO: Select this position when you tune in a very weak or noisy FM station. Although the sound will come out in monaural the noise will be greatly reduced.
- 13** IF (intermediate frequency) BAND button
 To prevent inter-station interference, press this button. The NARROW indicator appears on the display and the selectivity is improved.
- 14** DISPLAY button
15 ANT ATT button
16 CHARACTER button
 Press this button when you record an FM stereo program using the Dolby NR* (Noise Reduction) system. The MPX FILTER indicator appears. This filter cuts off the 38 kHz subcarrier signals, which may otherwise interfere with proper operation of the Dolby NR* (Noise Reduction). If your deck has an MPX FILTER button, use that button rather than the button of this tuner.
 * Dolby noise reduction manufactured under License from Dolby Laboratories Licensing Corporation. "DOLBY" and the double-D symbol  are trademarks of Dolby Laboratories Licensing Corporation.
- 17** DISPLAY MODE button
18 PROGRAM switch and CHECK button
19 ANT button

1-2. BROADCAST RECEPTION

1-2-1. Tuning in Manually

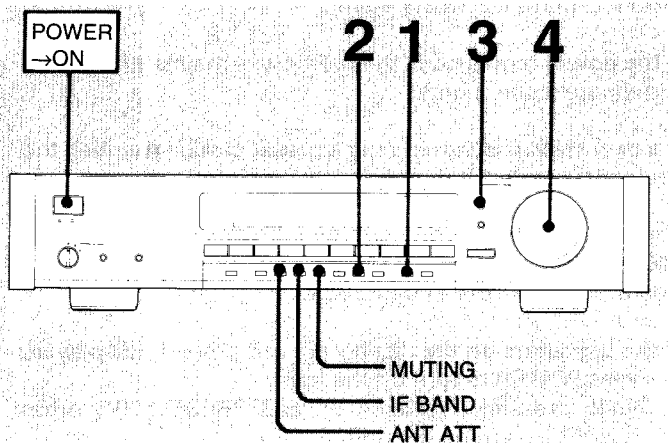

- 1** Select the desired band with the band selector.
- 2** If the AUTO indicator appears on the display, press **TUNE MODE**. The AUTO indicator disappears.
- 3** Check if the TUNING indicator appears on the display. If not, press TUNING/PRESET.
- 4** Find the desired station by turning the TUNING knob toward ► for higher frequencies or ◀ for lower frequencies.

For FM stereo reception

Normally, press MUTING.

MUTING indicator appears on the display. To tune in a very weak FM station, press again to reset it. The MUTING indicator goes off.

To receive a weak FM broadcast

Set MUTING off (press MUTING so that the MUTING indicator disappears from the display window), and if it is still noisy, set FM MODE to the MONO mode.

To tune in only stations with strong signals

Press ANT ATT to make the ANT ATT indicator appear.

When the desired station is interfered with adjacent stations

Press the IF BAND button so that the NARROW indicator appears in the display window. In this mode, the selectivity increases so that interference-free sound is obtained.

1-2-2. Tuning in Automatically

(FM only for European countries, FM and AM for other countries)

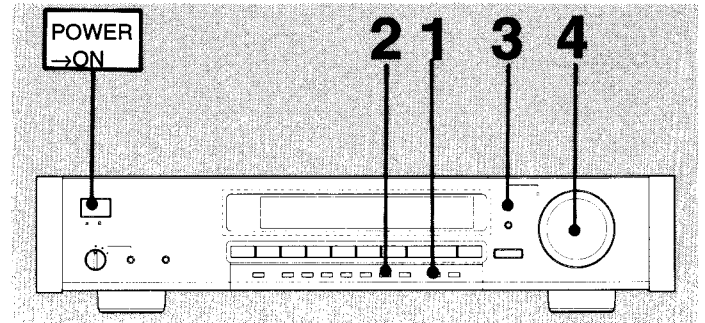

- 1** Select the desired band with the band selector.
- 2** Press **TUNE MODE** so that the AUTO indicator appears on the display.
- 3** Check if the TUNING indicator appears on the display. If not, press TUNING/PRESET.
- 4** Turn the TUNING knob toward ► for higher or ◀ for lower frequencies.
When automatic frequency scanning starts, release the knob. Scanning stops when a signal is received. If the signal is not the desired one, turn the knob again to restart scanning.

To receive other stations

When the received station is not the one you want, turn TUNING knob again.

To receive a strong FM broadcast

Normally, set MUTING on (press MUTING so that the MUTING indicator appears on the display) to reduce noise. Also, set FM MODE to the auto stereo mode. The unit operates in the stereo mode for a stereo signal, and automatically switches to the monaural mode for a monaural signal. If it is still noisy, set FM MODE to the HI-BLEND mode.

1-2-3. Storing station frequency into memory

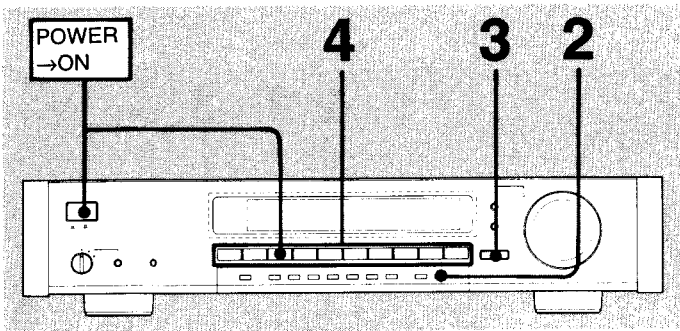

A total of 30 FM/AM stations (Station names can be stored only twenty among of thirty stations) in any band can be memorized.

Storing all stations automatically

To preset the frequencies and other modes of 30 stations, press the PRESET button 3 while pressing POWER. To preset the frequencies, station names, and other modes of 20 stations, press the PRESET button 2 while pressing power.

Once they are presetted, they will be memorized. (Even for 1 month with the power off)

Storing one station at a time

- 1** Tune in the desired station.
- 2** Press MEMORY.
"MEMORY" appears in the window.
- 3** Press SHIFT to select the memory page A, B, or C.
- 4** Select a preset number with the PRESET button.

Repeat the above steps for each station to be stored in memory.

Notes on storing

If you select an incorrect number, press the MEMORY button again and select the correct number.

If the MEMORY indicator disappeared, before you pressed PRESET, press MEMORY again.

If the power remains off, the memory is maintained for approximately one month.

If a new station is stored over a preset station number, the previously stored station is erased.

If you set the ANTENNA, ANT ATT, IF BAND, MUTING, FM-MODE or the name of the station, they can be stored when you press MEMORY and PRESET.

If the indicators on the display are not properly displayed,

- 1 Press POWER to turn off the unit.
- 2 While pressing PRESET "9" and PRESET "0", press POWER to turn on the unit.

This unit is reset to initial state and all of the stored stations and settings are erased.

1-2-4. Receiving a Stored Station

Method A: When you know the preset number of the desired station.

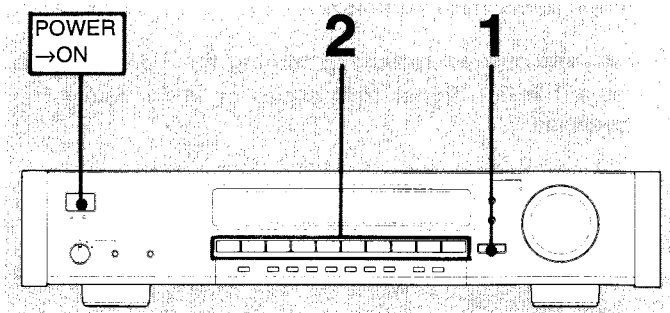

- 1** Press SHIFT to select the memory page A, B, or C (A, B only if you have stored station names).
- 2** Select the desired number with the PRESET button.

Method B: When you don't know the preset number of the desired station.

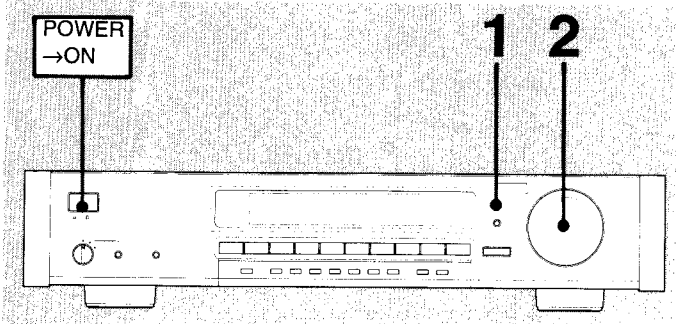

- 1** Press **TUNING/PRESET** to make the PRESET indicator appear.
- 2** Find the desired station by turning the TUNING knob control toward ► for higher numbered stations or ◀ for lower numbered stations.

1-2-5. Scanning Stored Stations Automatically

Press TUNE MODE to make "AUTO" appear and turn the TUNING knob.

If scanning does not start

Scanning starts only when you turn the TUNING knob while the code indicator is flashing. If the flashing has stopped, press TUNE MODE again.

1-2-6. Scanning Stored Stations Manually



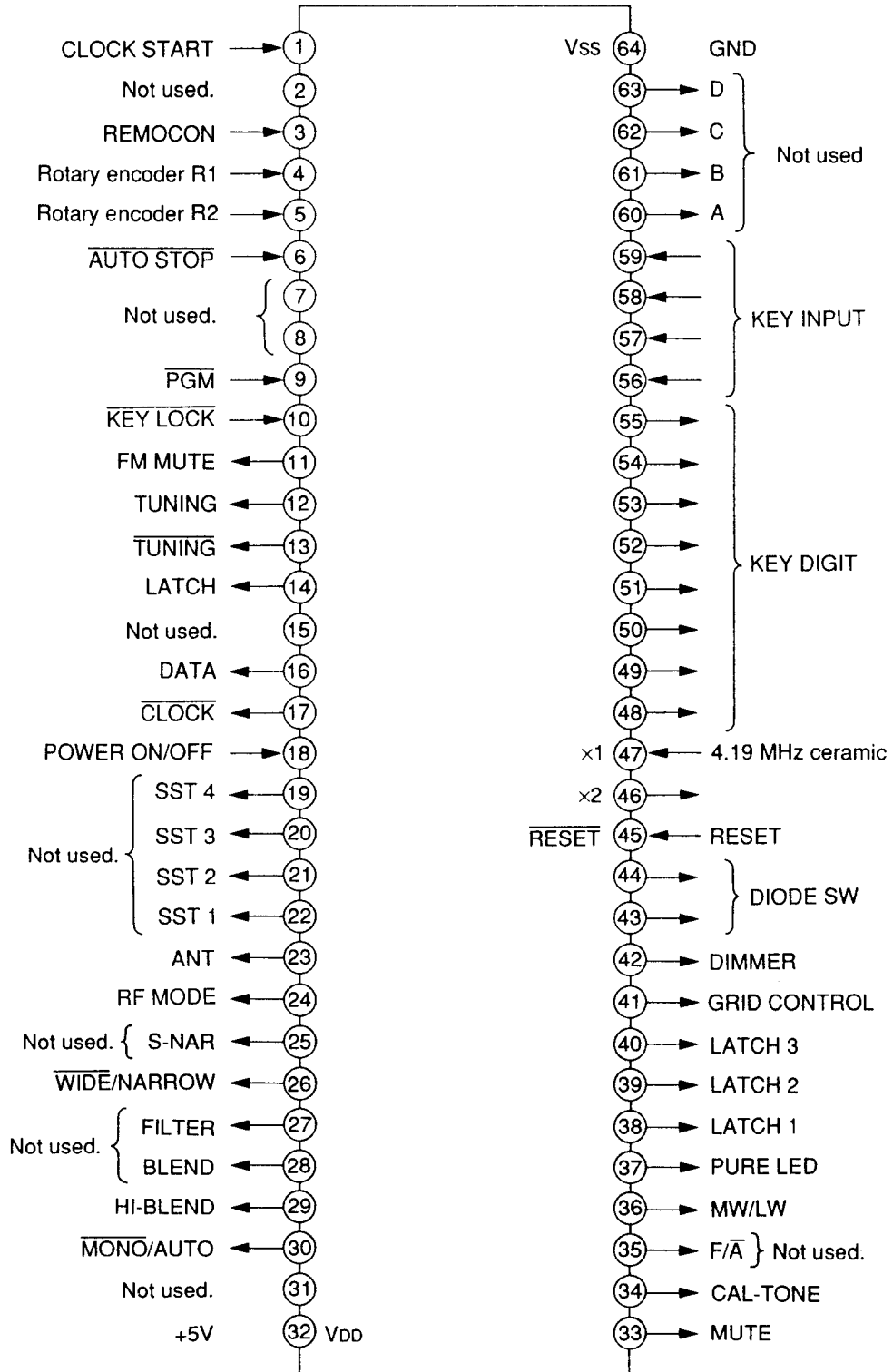

1. Press TUNING/PRESET to make the PRESET indicator appear.
2. Press TUNE MODE.
AUTO indicator goes off.
3. Turn TUNING/CHARACTER, until desired station is received.

SECTION 2
IC PIN FUNCTIONS

2-1. IC601 (μ PD75108CW-A76) PIN FUNCTIONS



• IC601 SYSTEM CONTROLLER (μPD75108CW-A76) PIN FUNCTION

Pin No.	Pin Name	I/O	ACTIVE	Description
1	CLOCK START	I	H	Stop mode control input. (1) When there is no key input continuously for 2 seconds and the signal remains "L", the I/O port is maintained in the state immediately before and the stop mode is entered. PURE (pin 37) goes "H" and D701 lights. (2) When there is a key input,  releases the stop mode. PURE (pin 37) goes "L".
2	N.C.	I		Not used.
3	REMOCON	I		Remote control signal input.
4	R1	I		Rotary encoder rotation detect input (*1)
5	R2	I		Rotary encoder rotation detect input (*1)
6	AUTO STOP	I	L	Auto stop signal input from IC251. "L": when signal detect
7	N.C.	I		Not used.
8	N.C.	I		Not used.
9	PGM	I	L	PROGRAM switch (S661) input. "L": PROGRAM
10	KEY LOCK	I	L	PROGRAM switch (S661) input. "L": KEY LOCK
11	F-MUT	O	H	FM MUTING output. "H": MUTE
12	TUN	O	H	FM MUTING SENS select output. "L": STOP, "H": TUNING
13	TUN	O	L	AM muting output. "H": STOP, "L": TUNING
14	LATCH	O	H	Signal meterdriver (IC705) latch output.
15	N.C.	I		Not used.
16	DATA	O	H	Display data output to FL driver (IC501, 701 - 703, 705)
17	CLK	O	L	Data transfer clock output to FL driver (IC501, 701 - 703, 705)
18	POWER	I	H	Power down detect input "H": normal, "L": power down
19 - 22	SST4 - SST1	O	H	Not used (pull up)
23	ANT	O	L	FM antenna select output. "L": antenna "A". "H": antenna "B"
24	RF MODE	O	H	Antenna attenuator ON/OFF output. "L": through, "H": ATT
25	S-NAR	O	H	Not used (pull up)
26	W/N	O	H	Wide/Narrow select output. "L": WIDE, "H": NARROW
27	FILTER	O	H	Not used (pull up)
28	BLD	O	H	Not used (pull up)
29	HI-B	O	H	HIGH BLEND switch (Q306) control output.
30	MONO/AUTO	O	H	Auto stereo select switch. "H": AUTO STEREO
31				Not used.
32	VDD	-		Power supply terminal (+5V)
33	MUT	O	H	Line mute output. "H": MUTE
34	CAL	O	L	CAL TONE ON/OFF output. "L": CAL TONE
35	F/A	O	H	Not used (open)

Pin No.	Pin Name	I/O	ACTIVE	Description
36	M/L	O	H	MW/LW select output, "H": MW, "L": LW
37	PURE	O	H	PURE LED (D701) ON/OFF output. "H": ON (stop mode)
38	LATCH 1	O	H	FL driver (IC701) latch output
39	LATCH 2	O	H	FL driver (IC702) latch output
40	LATCH 3	O	H	FL driver (IC703) latch output
41	GRID	O	L	FL indicator tube grid control output (center grid 2G) (*2)
42	DIMMER	O	L	FL indicator tube grid control output (both sidesgrid 1G, 3G) (*2)
43 - 44	DIODE	O	H	Diode switch output.
45	RESET	I	L	System RESET input. "L": RESET
46	X2	O		Clock output
47	X1	I		Clock input (4.19 MHz)
48 - 55	KEY DI (S1)	O	H	Key matrix output
56 - 59	KEY INPUT	I	H	Key matrix input
60 - 63	LED A - LED D	O		Not used (pull down)
64	GND	-		Power supply terminal (GND)

*1 Rotary encoder rotation detect

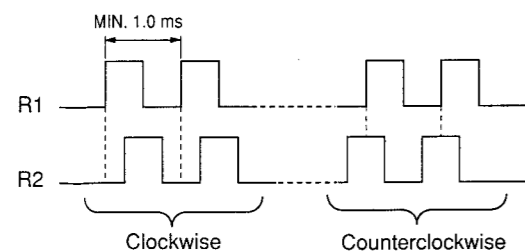

*2 When the **DISPLAY MODE** key is pressed, the FL display changes cyclically as follows.

→ Fully lit → Partially lit → Not lit

The output ports change as follows.

	Fully lit	Partially	Not lit
41 pin GRID	L	L	H
42 pin DIMMER	L	H	H

* When the **BAND** key is pressed, the output ports change cyclically as shown in the table below.

	FM	MW	LW
36 pin MW/LW	H	L	L
IC501 CX7925 8 pin AO	H	L	L
IC501 CX7925 9 pin BO	DON'T CARE	H	L

• TEST MODE

When the **SHIFT** key is held depressed and the power is turned on, all segments in the FL display light while the key is held, so simple checking can be done.

When the **SHIFT** key is released, normal operation is restored.

SECTION 3
BLOCK DIAGRAM

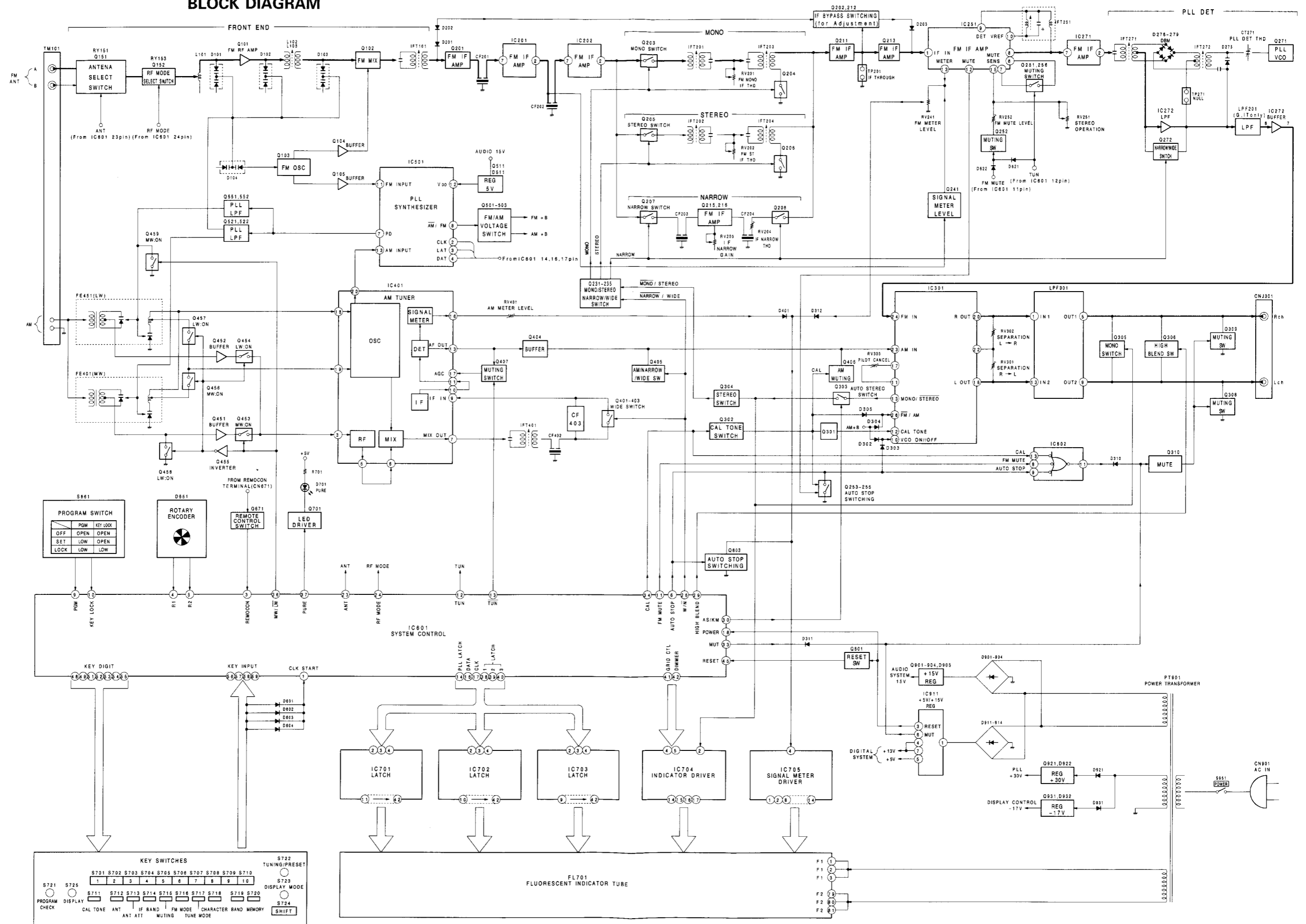

SECTION 4 ELECTRICAL ADJUSTMENTS

Notes: Perform adjustment in the order given.

• Parts location diagram relevant to the adjustment.

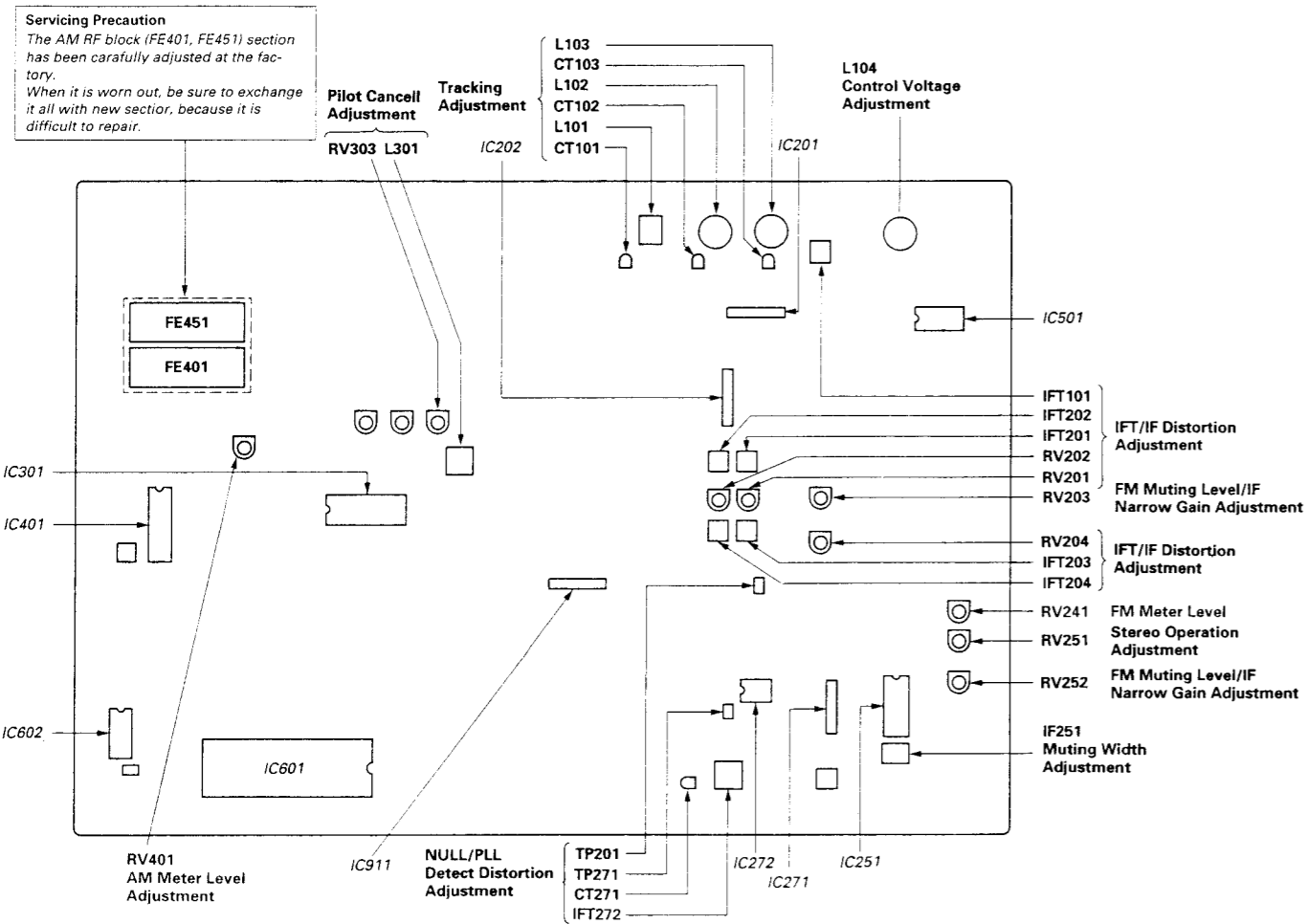

FM SECTION

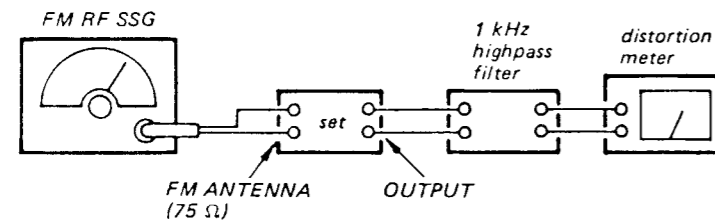

• Standard signals for adjustment.

FM RF Stereo Signal	FM RF Monaural Signal
Carrier frequency : 98 MHz	Carrier frequency : 98 MHz
Modulation : Audio 1 kHz, 16.25 kHz deviation (21.7%)	Modulation : Audio 1 kHz, 40 kHz deviation (53%)
Subchannel 16.25 kHz deviation (21.7%)	
Pilot 19 kHz, 7.5 kHz deviation (13.3%)	

Control Voltage Adjustment

Procedure:

1. Turn the set to 108 MHz.
2. Adjust L104 for 21.0 ± 0.2 V reading on the VTVM.
3. Tune the set to 87.5 MHz.
4. Confirm that the voltage reading on the VTVM is within 8.0 ± 1.0V.

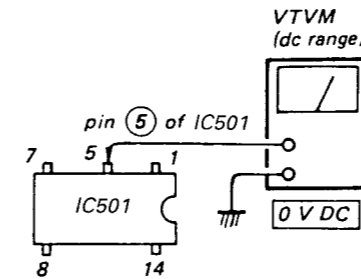

Tracking Adjustment

Setting:

IF BAND : NARROW

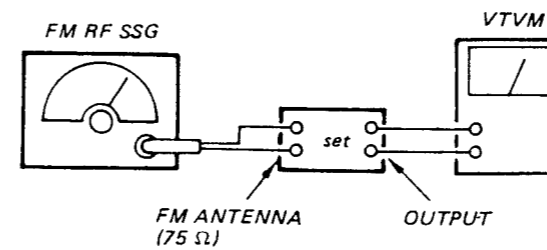

Procedure:

1. Tune the set to 108 MHz.
2. Adjust CT101, CT102 and CT103 for maximum reading on the VTVM.
3. Tune the set to 87.5 MHz.
4. Adjust L101, L102 and L103 for maximum reading on the VTVM.
5. Repeat the step 2 - 4 several times.

Muting Width Adjustment

Setting:

IF BAND : WIDE
MUTING switch : ON
FM RF SSG

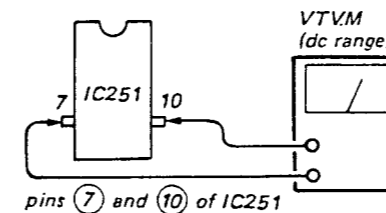
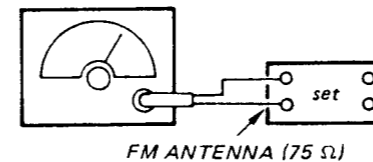

Carrier frequency: 98 MHz
Modulation: FM RF Monaural signal
Output level: 10 mV (80 dBμ)

Procedure:

1. Tune the set to 98 MHz.
2. Adjust IFT251 for 0V reading on the VTVM.

NULL/PLL Detect Distortion Adjustment

Setting:

IF BAND : WIDE
MUTING switch: ON

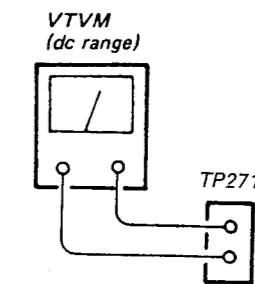

Procedure:

1. Tune the set to 98 MHz.
2. Short-circuit TP201 to the ground (The set turns into IF through state.)
3. Set the SSG output to 80 dBμ (10 mV).
4. Adjust IFT272 for 0 V reading on the VTVM (TP271). (Null adj.)
5. Adjust CT271 for minimum distortion reading on the distortion meter. (PLL Detect Distortion adj.)
6. Repeat the step 4 and 5 several times.
7. Remove the short circuit of TP201.

IFT/IF Distortion Adjustment

Setting:

IF BAND : WIDE
MUTING switch: OFF

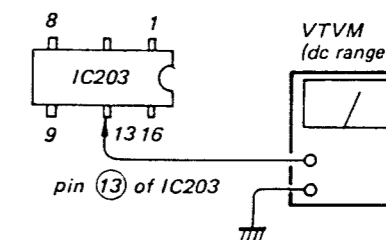

Procedure:

1. Tune the set to 98 MHz.
2. Turn RV201 and RV202 to fully clockwise.
3. Set the SSG output to 40 dBμ (100 μV) at monaural modulation mode.
4. Adjust IFT201 for maximum reading on the VTVM. (IF Distortion Pre adj. • MONO)
5. Set the SSG output to 40 dBμ (100 μV) at stereo modulation mode.
6. Adjust IFT202 for maximum reading on the VTVM. (IF Distortion Pre adj. • STEREO)
7. Adjust IFT101 for maximum reading on the VTVM (IFT adj.)
8. Set the SSG output to 80 dBμ (10 mV) at monaural modulation mode.
9. Turn RV201 and RV202 to mechanical center position.
10. Adjust IFT203 for the minimum distortion. (IF Distortion adj. • MONO)
11. Set the SSG output to 80 dBμ (10 mV) at stereo modulation mode. (Lch only)
12. Adjust IFT204 for the minimum distortion. (IF Distortion adj. • STEREO)
13. IF BAND: NARROW
14. Adjust RV204 for the minimum distortion. (IF Narrow Distortion adj.)

Stereo Operation Adjustment

Setting:
 IF BAND : WIDE
 MUTING switch: OFF
 FM RF SSG

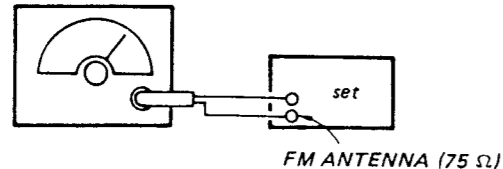

Carrier frequency: 98 MHz
 Modulation: FM RF Stereo signal
 Output level: 10 μV (20 dB)

Procedure:
 1. Tune the set to 98 MHz.
 2. Adjust RV251 so that the STEREO indicator goes on.

FM Muting Level/IF Narrow Gain Adjustment

Setting:
 IF BAND : WIDE
 MUTING switch: ON
 FM RF SSG

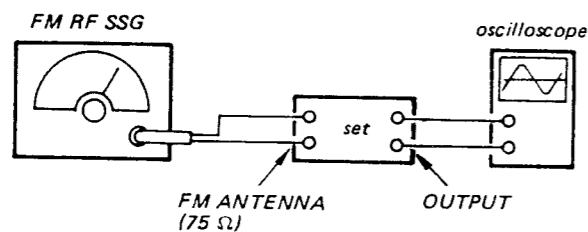

Carrier frequency: 98 MHz
 Modulation: FM RF Monaural signal
 Output level: 12.6 μV (22 dB)

Procedure:
 1. Tune the set to 98 MHz and adjust output level of signal generator at 25 dBμ (17.8 μV).
 2. Turn RV252 at the position where the waveform suddenly appears on the oscilloscope (FM Muting level adj.)
 3. IF BAND : NARROW
 4. Turn RV203 at the position where the waveform suddenly appears on the oscilloscope (IF Narrow Gain adj.)

FM Meter Level Adjustment

Setting:
 IF BAND : WIDE
 FM RF SSG

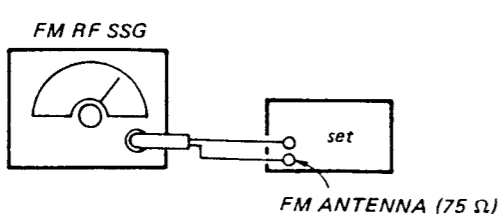

Carrier frequency: 98 MHz
 Modulation: FM RF Monaural signal
 Output level: 3 mV (70 dBμ)

Procedure:
 1. Tune the set to 98 MHz.
 2. Adjust RV241 so that 1 - 10 indication bars light up on the signal meter.

Pilot Cancell Adjustment

Setting:
 IF BAND : WIDE
 FM RF stereo signal generator

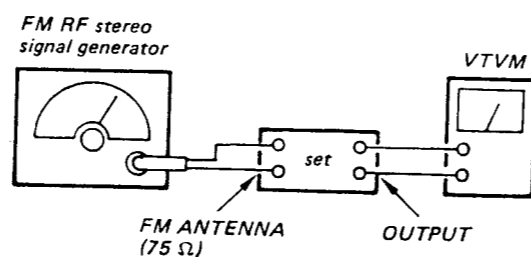

Carrier frequency: 98 MHz
 Modulation: pilot only
 Output level: 10 mV (80 dBμ)

Procedure:
 1. Turn the set to 98 MHz.
 2. Adjust RV303 and L301 alternately for minimum reading on the VTVM and also tune the both channel of L-CH and R-CH balanced at this time.
 3. Repeat the step 2 several times.

Stereo Separation Adjustment

Setting:
 IF BAND : WIDE
 FM RF stereo signal generator

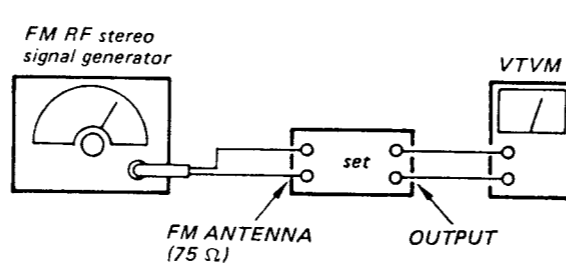

Carrier frequency: 98 MHz
 Modulation: FM RF stereo signal
 Output level: 10 mV (80 dBμ)

Procedure:

FM stereo signal generator output channel	VTVM connection	VTVM reading (dB)
L-CH	L-CH	(A)
R-CH	L-CH	(B) Adjust RV301 for minimum reading.
R-CH	R-CH	(C)
L-CH	R-CH	(D) Adjust RV302 for minimum reading.

L-CH Stereo separation: (A) - (B)
 R-CH Stereo separation: (C) - (D)
 The separations of both channels should be equal.

AM SECTION

Setting:

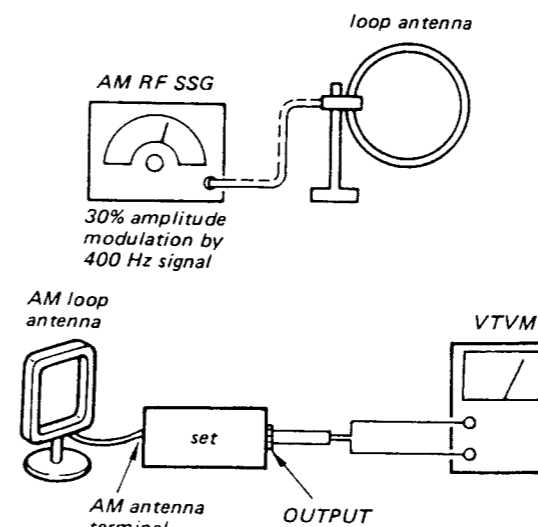

AM Meter Level Adjustment

Setting:
 Carrier frequency: 216 kHz
 Modulation: 400 Hz, 30% modulation

Procedure:
 1. Set AM RF signal generator so that the AM antenna input level becomes 74 dBμ/m (5 mV/m.)
 2. Adjust RV401 so that 1 - 10 indication bars light up on the signal meter.

• Semiconductor Location

Ref. No.	Location	Ref. No.	Location	Ref. No.	Location
D101	C-20	D627	J-22	Q233	D-18
D102	C-19	D628	I-22	Q234	E-18
D103	C-20	D651	H-31	Q235	E-18
D104	B-16	D671	C-28	Q241	D-17
D151	C-22	D701	G-1	Q251	J-17
D152	C-21	D703	H-12	Q252	I-15
D201	D-18	D901	E-20	Q253	I-15
D202	D-18	D902	E-20	Q254	I-15
D203	G-17	D903	E-20	Q255	I-15
D241	E-17	D904	E-20	Q256	J-15
D242	E-17	D905	F-20	Q271	J-20
D273	I-20	D911	G-21	Q272	I-18
D274	I-20	D912	G-21	Q301	F-23
D275	J-19	D913	F-22	Q302	H-28
D276	J-18	D914	F-21	Q303	F-23
D277	J-18	D921	F-20	Q304	F-22
D278	J-18	D922	G-20	Q305	C-25
D279	J-18	D931	F-21	Q306	C-24
D301	G-24	D932	G-20	Q308	B-26
D302	G-23	IC201	D-18	Q309	B-25
D303	G-23	IC202	E-19	Q310	H-28
D304	G-25	IC251	I-16	Q401	H-28
D305	G-25	IC271	I-17	Q402	H-27
D307	I-27	IC272	I-18	Q403	H-27
D310	H-27	IC301	F-24	Q404	G-26
D311	H-27	IC401	F-27	Q405	G-27
D312	H-16	IC501	C-16	Q406	H-26
D313	I-28	IC601	J-25	Q407	G-26
D401	F-25	IC602	I-27	Q408	H-27
D402	H-26	IC701	G-4	Q451	E-27
D511	D-16	IC702	G-6	Q452	E-28
D601	I-23	IC703	G-8	Q453	E-27
D602	I-23	IC704	H-11	Q454	E-28
D603	I-23	IC705	H-2	Q455	E-26
D604	I-23	IC911	G-21	Q456	E-26
D605	I-27	Q101	B-20	Q457	E-26
D606	I-27	Q102	B-18	Q458	E-27
D607	J-27	Q103	B-16	Q459	D-25
D608	J-27	Q104	B-17	Q501	D-16
D609	J-23	Q105	B-16	Q502	D-17
D610	J-23	Q151	B-23	Q503	D-17
D611	J-23	Q152	B-23	Q511	E-16
D612	J-23	Q201	C-17	Q521	D-16
D613	J-23	Q202	D-18	Q522	E-16
D614	J-23	Q203	E-18	Q551	E-16
D615	J-23	Q204	G-18	Q552	F-16
D616	J-23	Q205	E-19	Q601	K-27
D617	J-24	Q206	G-19	Q603	H-27
D618	J-24	Q207	E-18	Q671	C-27
D619	J-24	Q208	G-17	Q701	G-2
D620	I-27	Q211	G-19	Q901	D-20
D621	I-24	Q212	G-18	Q902	E-20
D622	I-24	Q213	G-18	Q903	E-20
D623	I-23	Q215	F-17	Q904	E-20
D624	J-22	Q216	F-17	Q921	F-20
D625	J-23	Q231	D-18	Q931	G-19
D626	J-22	Q232	D-18		

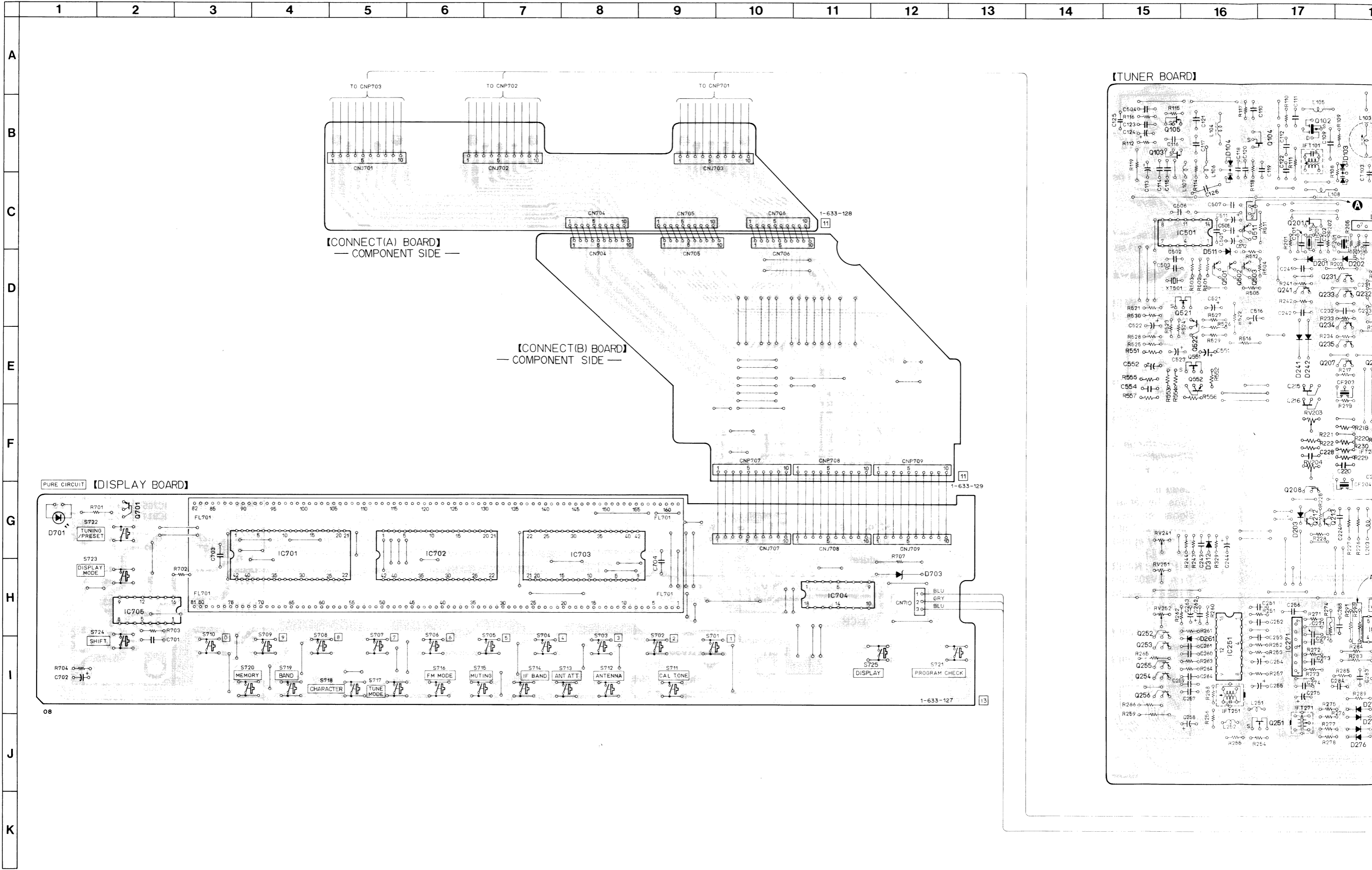

PURE CIRCUIT [DISPLAY BOARD]

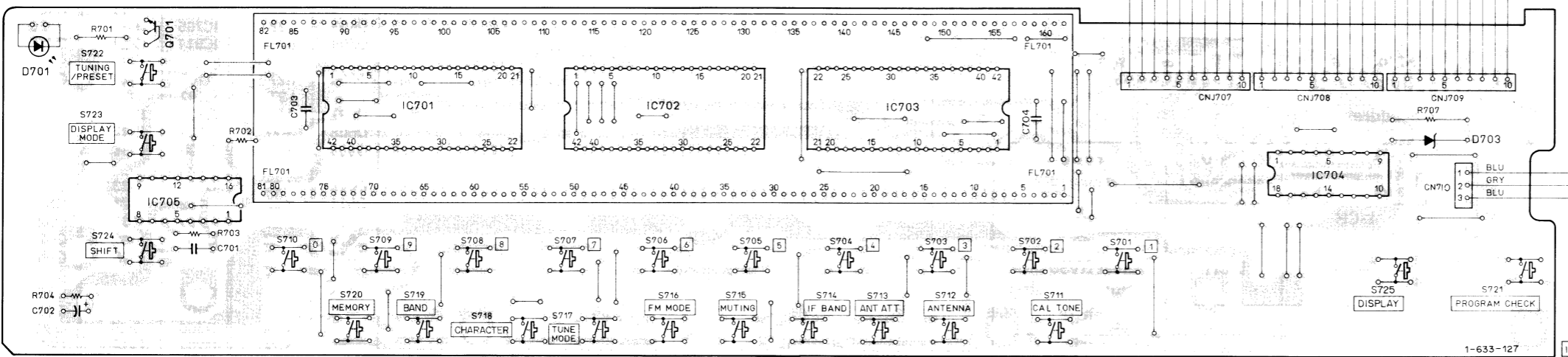

[TUNER BOARD]

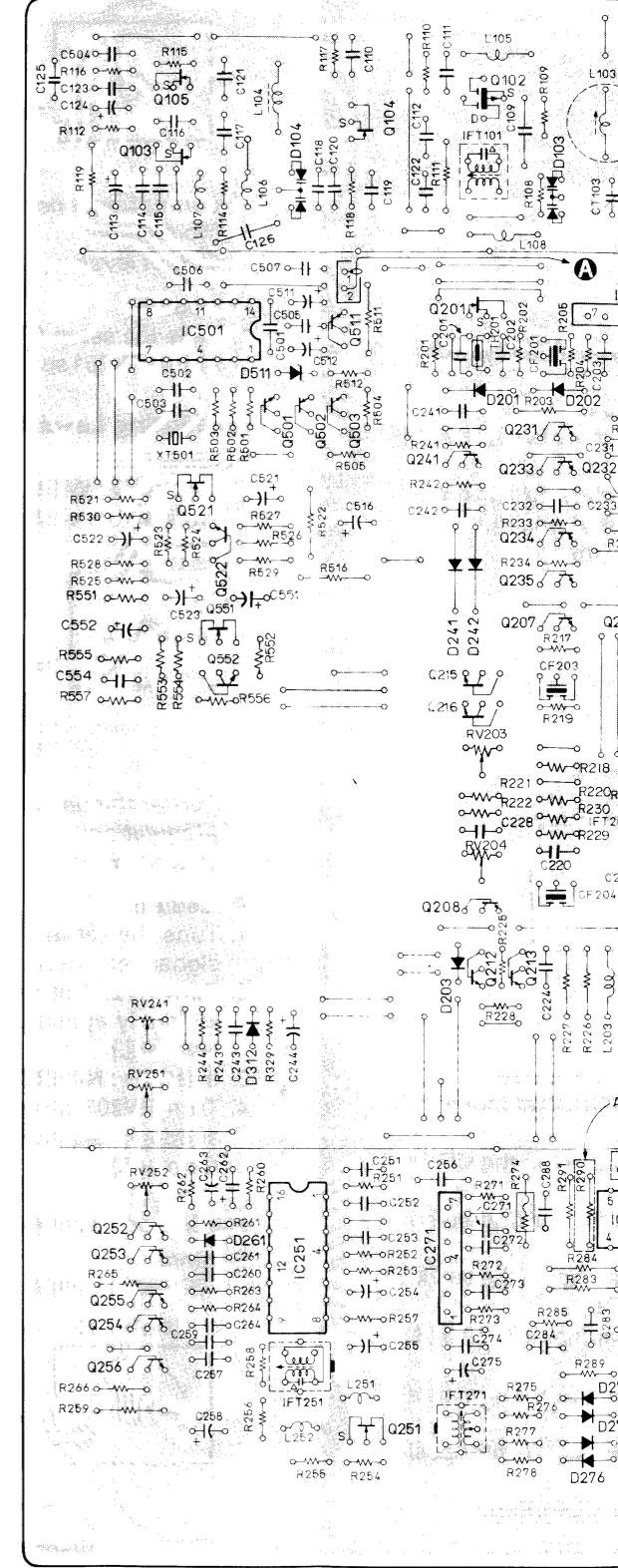

ER BOARD]

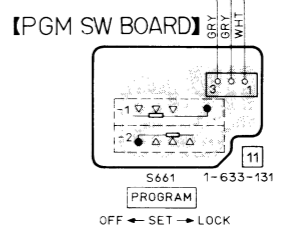
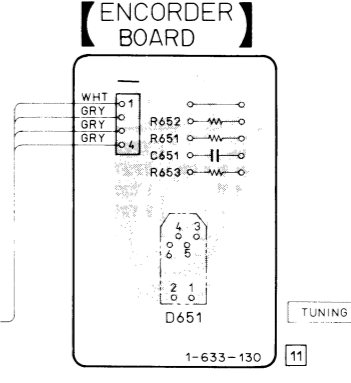
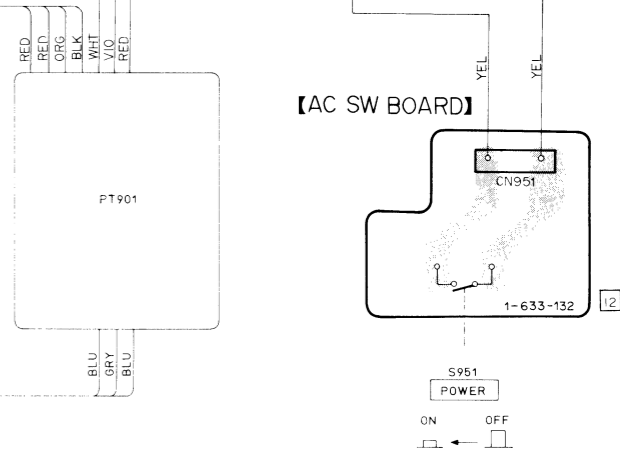
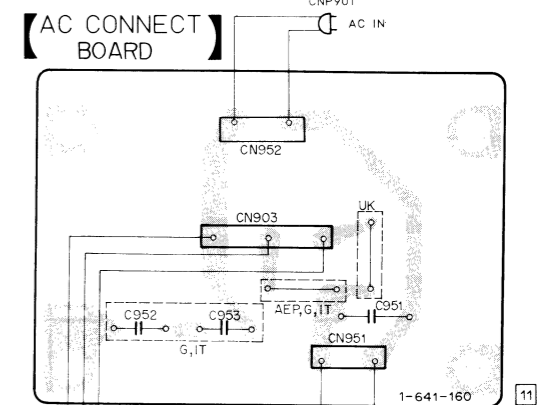
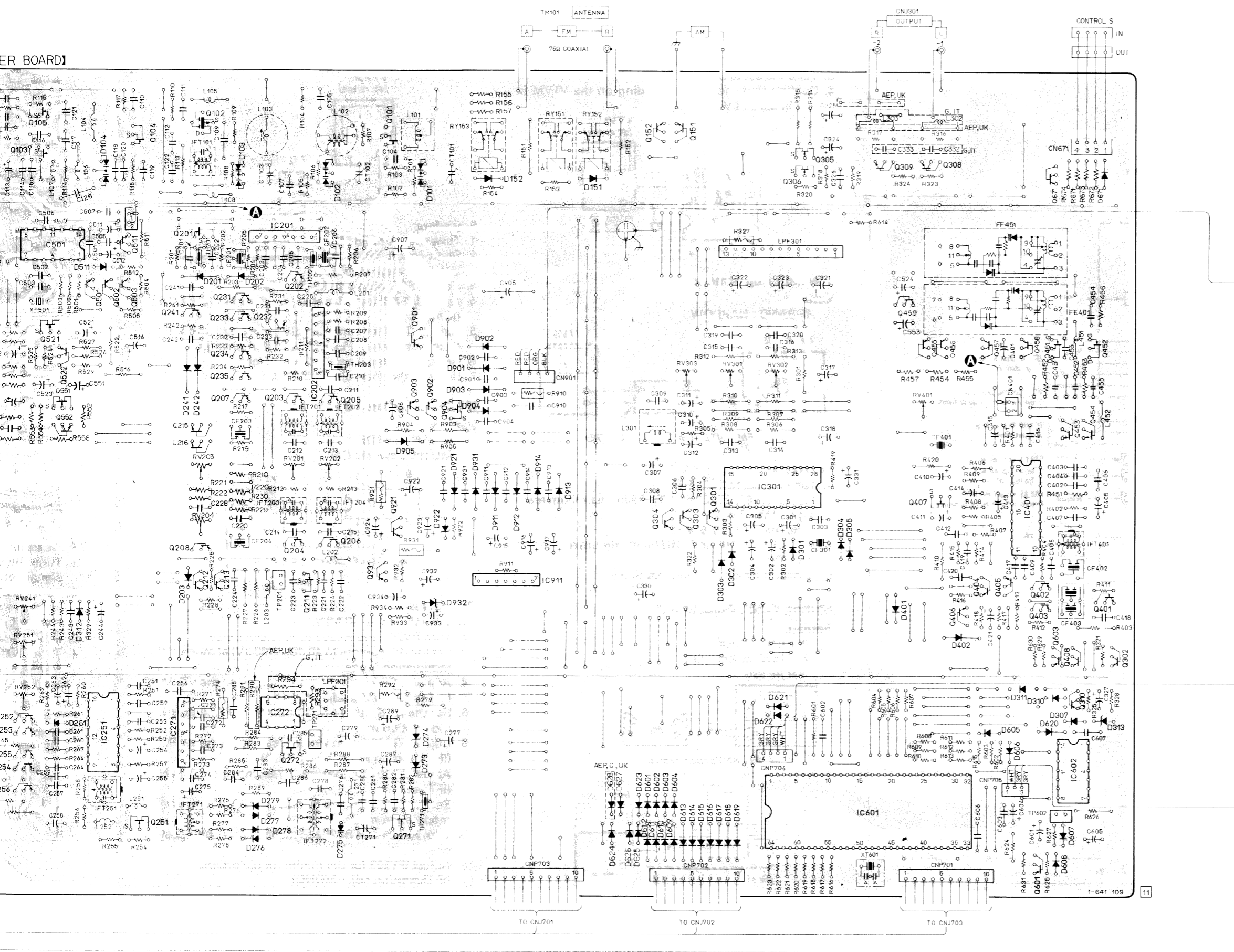

- Δ : internal component.
- $\text{---}\text{||}\text{---}$: fusible resistor.
- $\text{---}\text{||}\text{---}$: adjustment for repair.
- $\text{---}\text{||}\text{---}$: voltage are dc with respect to ground under no-signal (returned) condition.

- Voltage variations may be noted due to normal production tolerances.
- Component numbers refer to manufacturers.
- Ground path.

Note:
The components identified by mark Δ or dotted line with mark Δ are critical for safety.
Replace only with part number specified.

● Voltage are dc with respect to ground under no-signal (returned) condition.
● Mark FM () MW () LW ()

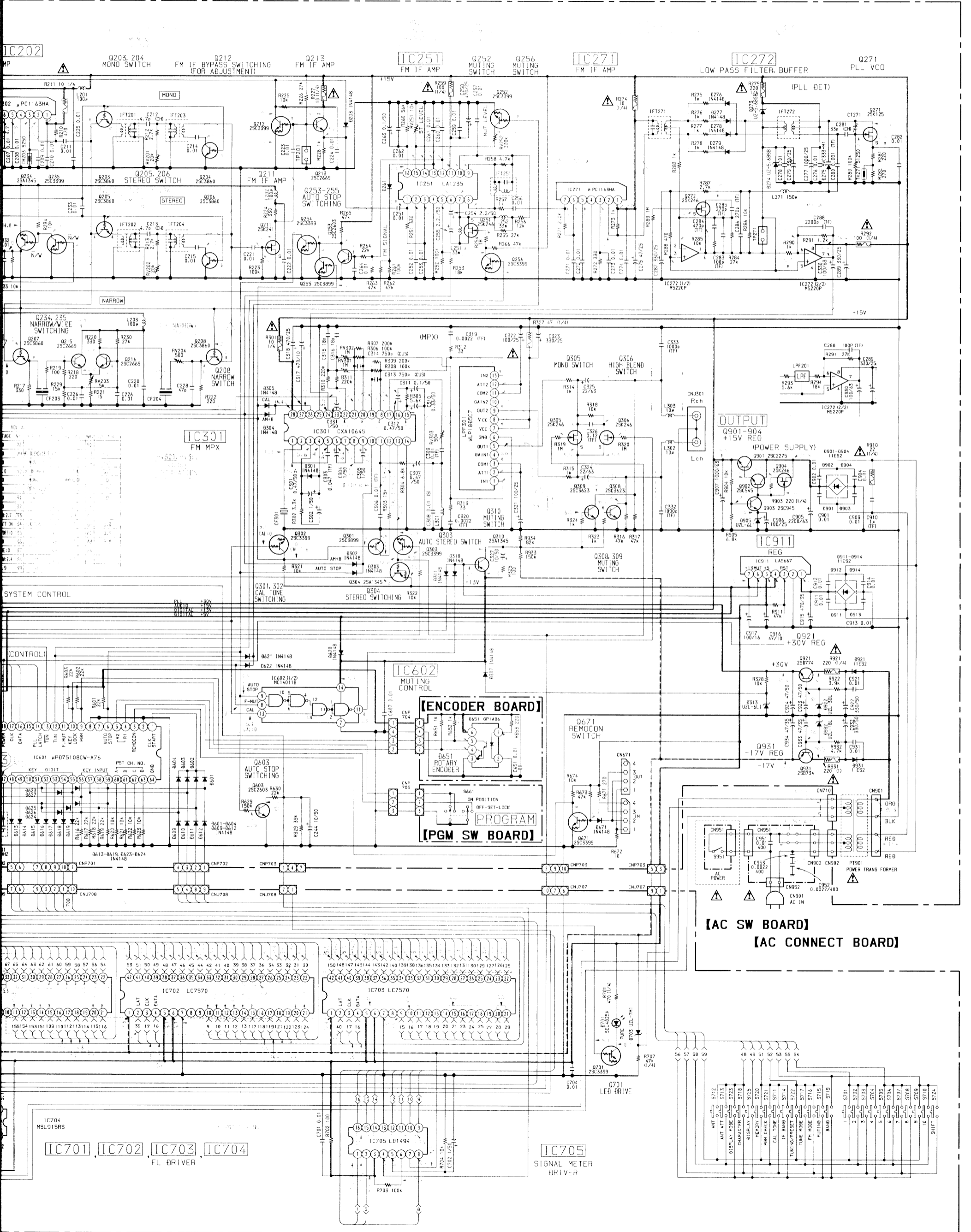

5-3. SCHEMATIC ON WAVEFORMS

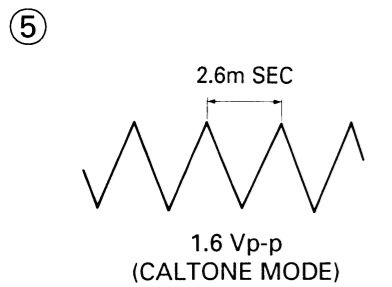
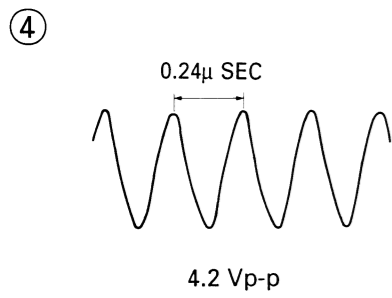
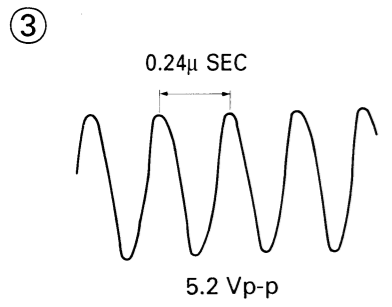
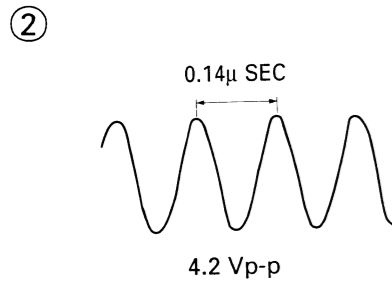
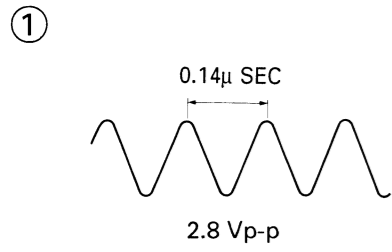

5-4. IC BLOCK DIAGRAM

IC201, 202, 271 μPC1163HA

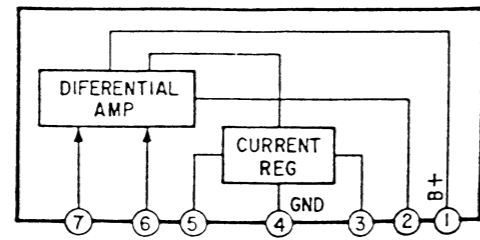

IC251 LA1235

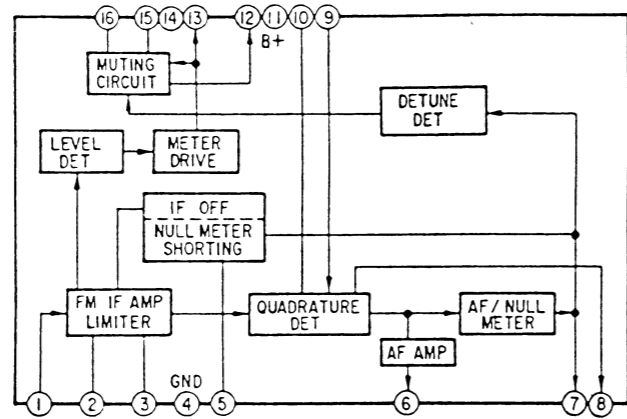

IC301 CXA1064S

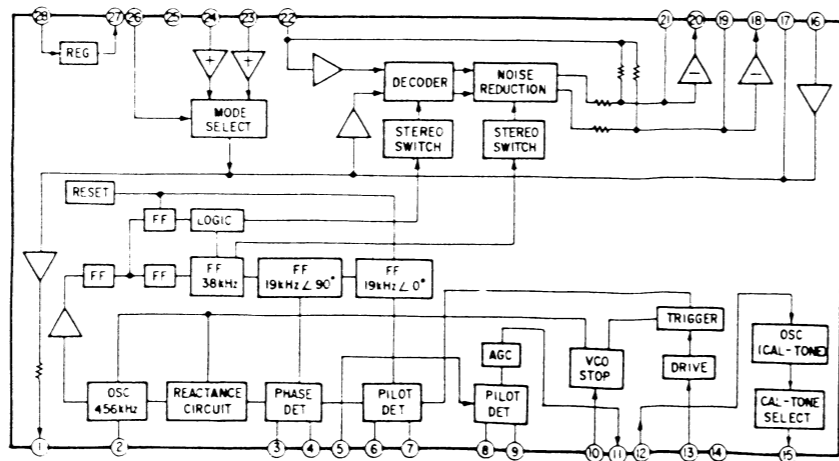

IC401 LA1245

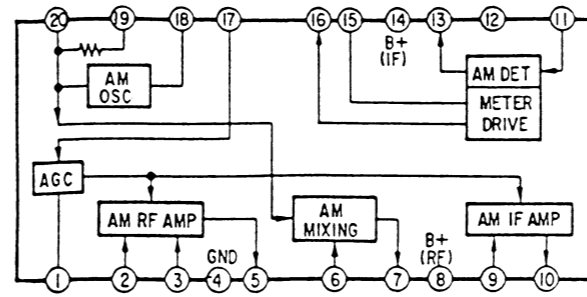

IC501 CX7925B

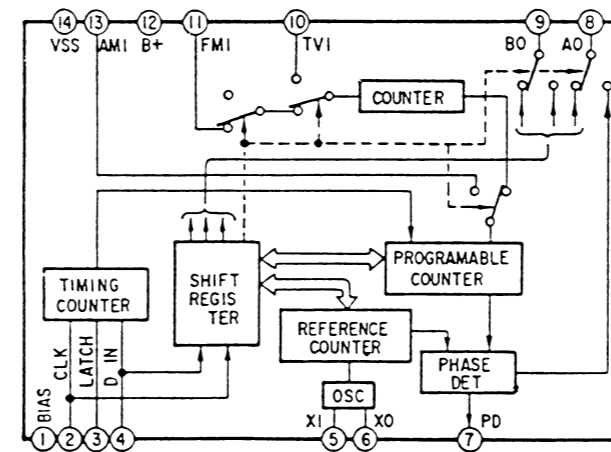

IC701, 702, 703 LC7570

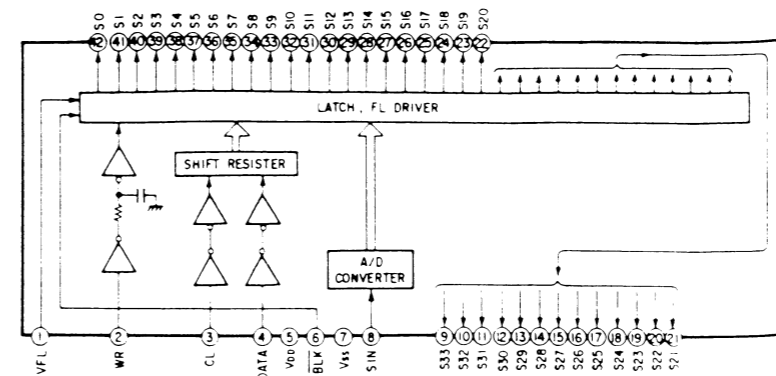

5-5. SEMICONDU

LA5667

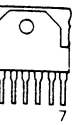

μPC1163HA

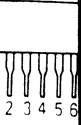

5-5. SEMICONDUCTOR LEAD LAYOUTS

IC401 LA1245

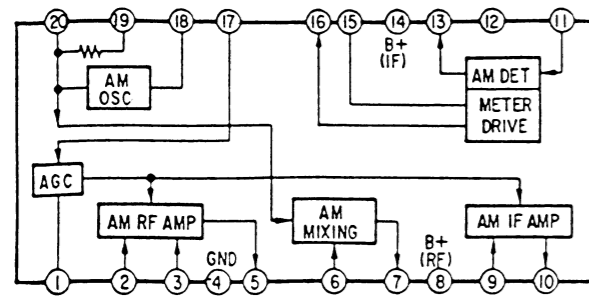

IC705 LB1494

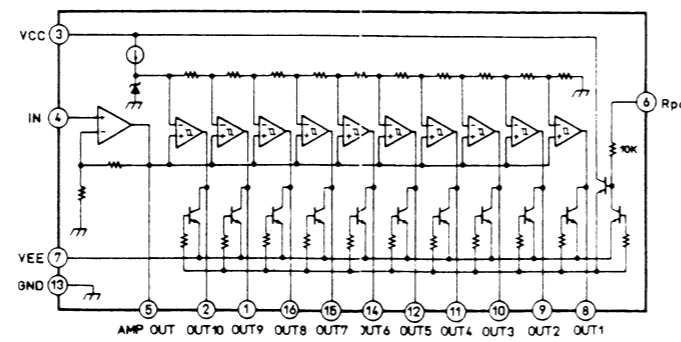

IC501 CX7925B

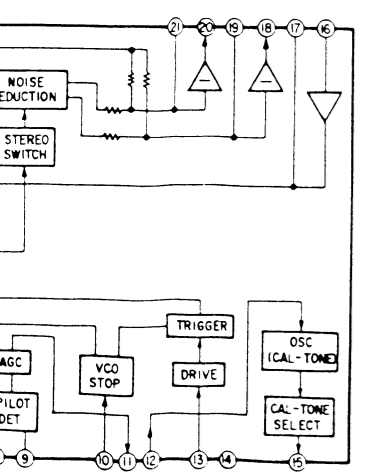
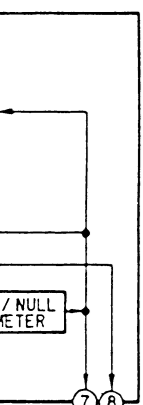
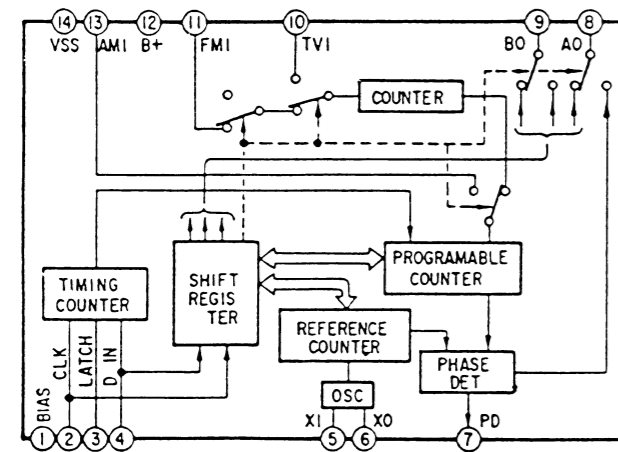

IC701, 702, 703 LC7570

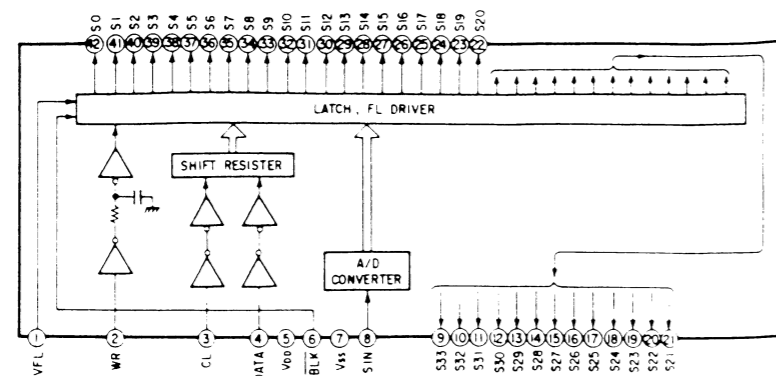

LA5667

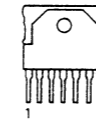

μPC1163HA

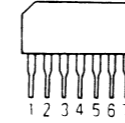

- DTA144ES
- DTC114ES
- DTC114TS
- DTC144ES
- 2SA1175-HFE
- 2SC2603-EF
- 2SC2669-0Y
- 2SC2785-HFE
- 2SC3623A-LK
- 2SC3899

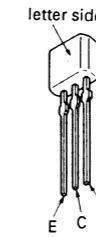

- 2SA1409-LK
- 2SC1815-GR



- 2SB734-34
- 2SD774-34



2SC2275-P

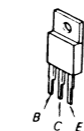

- 2SK125-3
- 2SK246-GR2
- 2SK30A-GR3

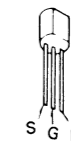

2SK152-3



- 2SK161-GR
- 2SK241-Y



3SK122K

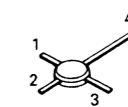

- 1. GATE 2
- 2. GATE 1
- 3. SOURCE
- 4. DRAIN

GP-1A06

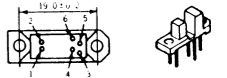

- 1. anode
- 2. cathode
- 3. GND
- 4. V02
- 5. V01
- 6. Vcc

KV1320

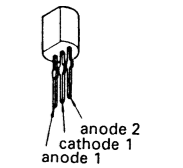

- HZS30-2L
- HZS-6A1L
- HZS-6A3L
- UZL-7M1
- 1SS120
- 1T22A
- 11ES2

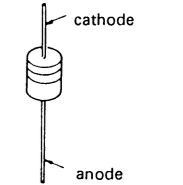

SEL4825A

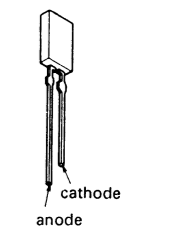

SVC333

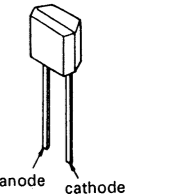



**SECTION 6
EXPLODED VIEWS**

6-1 CABINET ASSEMBLY

NOTE:

- _XX, _X mean standardized parts so they may have some differences from the original one.
- Color Indication of Appearance Parts
Example:
KNOB, BALANCE (WHITE) . . . (RED)
Parts color ↑ Cabinet's color
- Items marked "*" are not stocked since they are seldom required for routine service. Some delay should be anticipated when ordering these items.
- The mechanical parts with no reference number in the exploded views are not supplied.
- Hardware (#mark) list is given in the last of this parts list.

The components identified by mark  or dotted line with mark  are critical for safety. Replace only with part number specified.

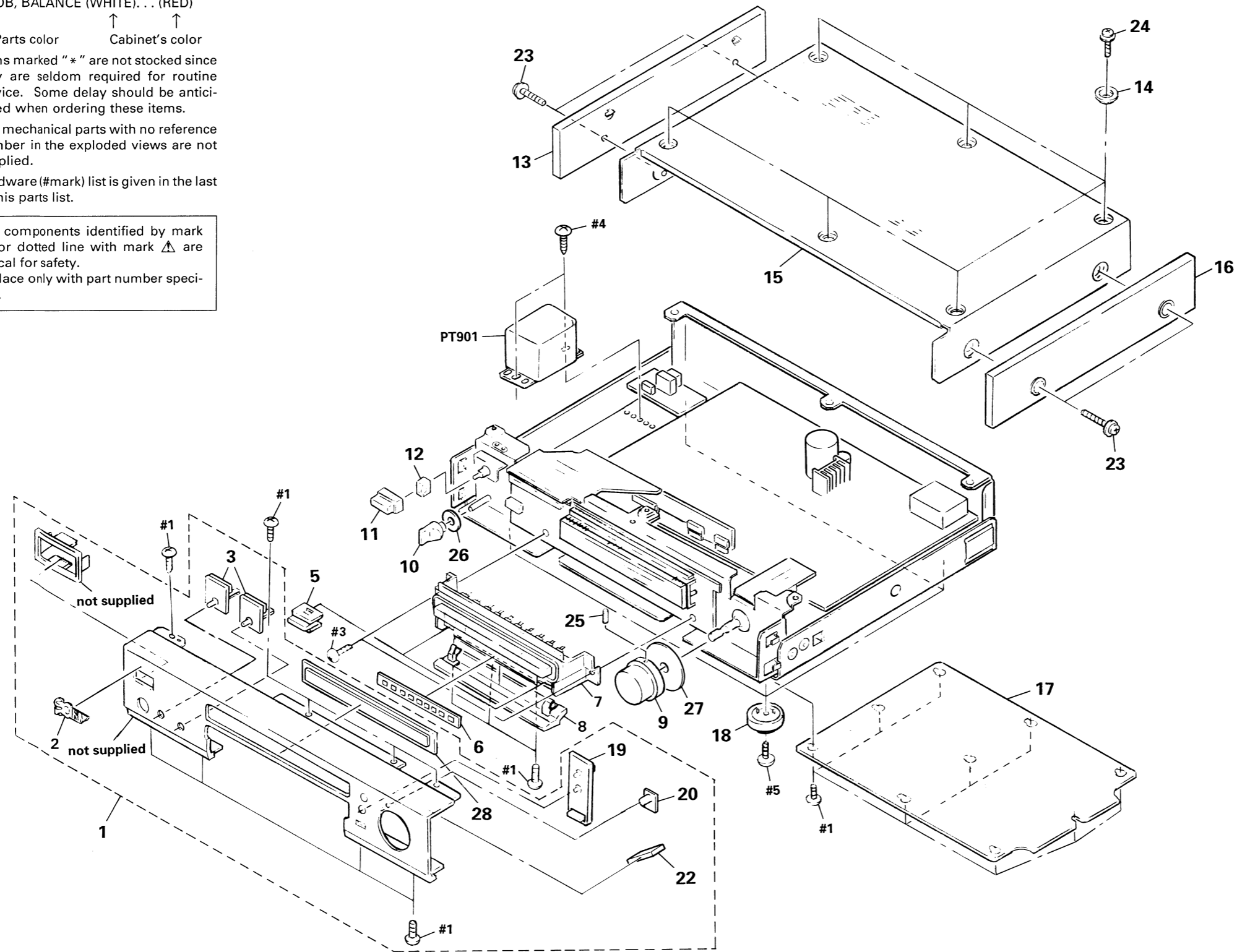

Ref. No.	Part No.	Description	Remark
1	A-4325-050-A	PANEL ASSY, FRONT... (GOLD) (AEP, G)	
1	A-4325-062-A	PANEL ASSY, FRONT... (BLACK) (AEP, G, IT)	
1	A-4325-064-A	PANEL ASSY, FRONT (UK)	
2	4-908-848-01	EMBLEM, SONY... (BLACK)	
2	4-908-848-21	EMBLEM, SONY... (GOLD)	
3	X-4886-042-1	BUTTON (A) ASSY... (BLACK)	
3	X-4941-920-1	BUTTON (A) ASSY... (GOLD)	
5	1-452-419-21	MAGNET	
6	4-923-475-11	PLATE, ORNAMENTAL... (BLACK)	
6	4-923-475-21	PLATE, ORNAMENTAL... (GOLD)	
7	X-4886-044-1	ESCUTCHEON ASSY, PANEL... (BLACK)	
7	X-4941-922-2	ESCUTCHEON ASSY, PANEL... (GOLD)	
8	X-4941-414-2	LID ASSY... (BLACK)	
8	X-4941-921-2	LID ASSY... (GOLD)	
9	4-923-482-01	KNOB... (BLACK)	
9	4-923-482-11	KNOB... (GOLD)	
10	4-908-097-21	KNOB... (BLACK)	
10	4-908-097-51	KNOB... (GOLD)	
11	4-908-046-01	KNOB, SQUARE... (BLACK)	
11	4-908-046-81	KNOB, SQUARE... (GOLD)	
12	4-864-307-00	RING	
13	X-4886-045-1	PANEL (LEFT) ASSY, SIDE... (BLACK) (AEP, IT)	
13	X-4941-416-1	PANEL (L) ASSY, SIDE... (BLACK) (G)	
13	X-4941-923-1	PANEL (L) ASSY, SIDE... (GOLD)	
14	4-923-474-01	RING, ORNAMENTAL... (BLACK)	
14	4-923-474-11	RING, ORNAMENTAL... (GOLD)	
15	4-935-802-11	CASE... (BLACK)	
15	* 4-935-802-21	CASE... (GOLD)	
16	X-4886-046-1	PANEL (RIGHT) ASSY, SIDE... (BLACK) (AEP, IT)	
16	X-4941-417-1	PANEL (R) ASSY, SIDE... (BLACK) (G)	
16	X-4941-924-1	PANEL (R) ASSY, SIDE... (GOLD)	
17	* 4-908-036-11	PLATE, BOTTOM	
18	X-3304-944-1	FOOT ASSY... (BLACK)	
18	X-3363-489-1	FOOT ASSY... (GOLD)	
19	X-4886-041-1	BUTTON (3 GANG) ASSY... (BLACK)	
19	X-4941-919-1	BUTTON (3 GANG) ASSY... (GOLD)	
20	4-884-612-21	INDICATOR, EJECT	
22	4-923-477-01	PLATE, LIGHT INTERCEPTION	
23	4-933-446-01	SCREW (SIDE PANEL) (AEP, G, IT)	
	3-704-366-01	SCREW (CASE) (M3X8) (UK)	
24	3-704-366-01	SCREW(CASE)(M3x8)	
25	3-701-506-01	SET SCREW, DOUBLE POINT 3X4	
26	3-533-938-00	CLOTH	
27	4-935-807-01	CLOTH, BLIND	
28	4-923-492-11	DISPLAY, WINDOW	
	PT901	 1-450-409-11 TRANSFORMER, POWER	

6-2. CHASSIS ASSEMBLY

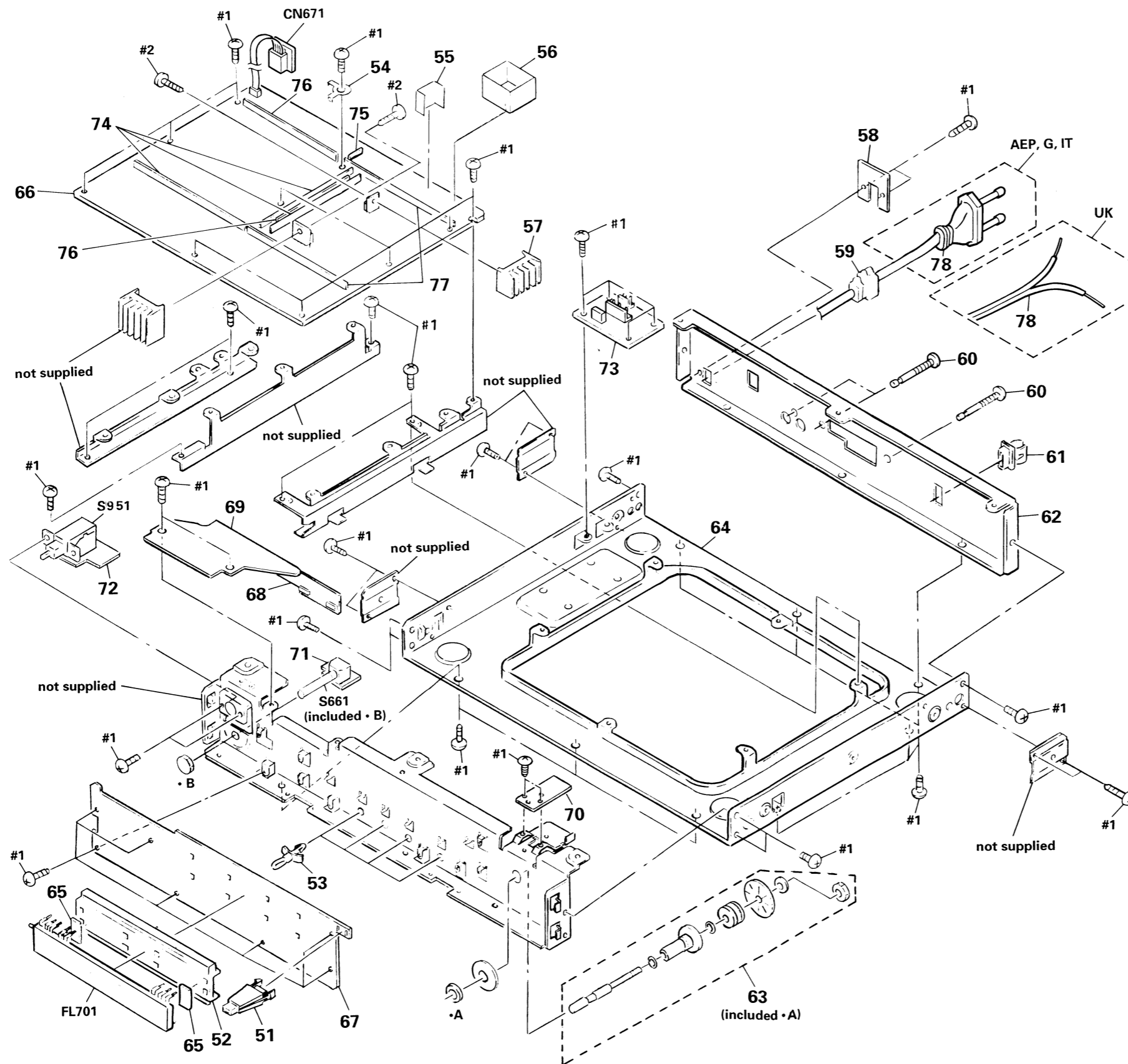

Ref.No.	Part No.	Description	Remark
51	* 3-304-605-11	HOLDER (NO 1), LED	
52	* 4-923-499-01	HOLDER (FL)	
53	* 3-703-353-01	SUPPORT, PC BOARD	
54	* 3-346-266-21	PLATE, GROUND	
55	* 4-911-325-01	PLATE (A), SHIELD	
56	* 2-287-441-01	PLATE, SHIELD	
57	* 4-921-402-01	HEATE SINK	
58	* 4-923-873-01	BRACKET, CORD STOPPER... (EXCEPT GOLD)	(G)
58	* 4-923-873-11	BRACKET, CORD STOPPER... (GOLD) (G)	
59	* 3-703-244-00	BUSHING (2104), CORD	
60	3-704-242-01	SCREW, TERMINAL. + BVTP CLAW	
61	* 4-908-019-01	HOLDER (A), ANTENNA	
62	* 4-923-498-12	PANEL, BACK... (BLACK)	
62	* 4-923-498-32	PANEL, BACK... (GOLD)	
63	* X-4886-023-1	PLATE ASSY, SLIT	
64	* 4-908-042-11	CHASSIS, MAIN	
65	* 4-923-479-01	SPACER	
66	* A-4345-296-A	TUNER BOARD, COMPLETE (AEP, UK)	
66	* A-4345-297-A	TUNER BOARD, COMPLETE (G)	
66	* A-4345-801-A	TUNER BOARD, COMPLETE (IT)	
67	* 1-633-127-11	DISPLAY BOARD	
68	* 1-633-128-11	CONNECT (A) BOARD	
69	* 1-633-129-11	CONNECT (B) BOARD	
70	* 1-633-130-11	ENCODER BOARD	
71	* 1-633-131-11	PGM SW BOARD	
72	* 1-633-132-11	AC SW BOARD	
73	* 1-641-160-11	AC CONNECTOR BOARD	
74	* 1-560-242-51	BUS BAR 7P	
75	* 1-560-242-61	BUS BAR 2P	
76	* 1-560-242-71	BUS BAR 6P	
77	* 1-560-242-91	BUS BAR 10P	
78	△ 1-574-383-11	CORD, POWER (AEP)	
78	△ 1-574-384-11	CORD, POWER (UK)	
S661	1-571-333-11	SWITCH, ROTARY	
S951	△ 1-572-267-11	SWITCH, PUSH (AC POWER) (1 KEY)	
CN671	* 1-559-135-41	CORD (WITH CONNECTOR)	
FL701	1-519-558-11	INDICATOR TUBE, FLOURESCENT	

The components identified by mark △ or dotted line with mark △ are critical for safety. Replace only with part number specified.

SECTION 7
ELECTRICAL PARTS LIST

DISPLAY
CONNECT(A)
CONNECT(B)
ENCODER

PGM SW
AC SW
AC CONNECTOR

- Due to standardization, replacements in the parts list may be different from the parts specified in the diagrams or the components used on the set.
- XX, X mean standardized parts, so they may have some difference from the original one.
- RESISTORS
All resistors are in ohms.
METAL : Metal-film resistor
METAL OXIDE : Metal Oxide-film resistor
F : nonflammable

- Items marked " * " are not stocked since they are seldom required for routine service. Some delay should be anticipated when ordering these items.
- SEMICONDUCTORS
In each case, u: μ , for example:
uA... : μ A..., uPA... : μ PA..., uPB... : μ PB,
uPC... : μ PC..., uPD... : μ PD
- CAPACITORS
uF: μ F
- COILS
uH: μ H

The components identified by mark Δ or dotted line with mark Δ are critical for safety.
Replace only with part number specified.

When indicating parts by reference number, please include the board name.

Ref. No.	Part No.	Description	Remark
* 1-633-127-11		DISPLAY BOARD *****	
* 1-633-128-11		CONNECT (A) BOARD *****	
* 1-633-129-11		CONNECT (B) BOARD *****	
* 1-633-130-11		ENCODER BOARD *****	
* 1-633-131-11		PGM SW BOARD *****	
* 1-633-132-11		AC SW BOARD *****	
* 1-641-160-11		AC CONNECTOR BOARD *****	
* 3-304-605-11		HOLDER (NO. 1), LED	
* 4-923-479-01		SPACER	
* 4-923-499-01		HOLDER (FL)	
< CAPACITOR >			
C651	1-161-379-00	CERAMIC 0.01uF 20% 25V	
C701	1-161-379-00	CERAMIC 0.01uF 20% 25V	
C702	1-124-903-11	ELECT 1uF 20% 50V	
C703	1-161-379-00	CERAMIC 0.01uF 20% 25V	
C704	1-161-379-00	CERAMIC 0.01uF 20% 25V	
C951	1-161-744-00	CERAMIC 0.01uF 400V	
C952	1-161-742-00	CERAMIC 0.0022uF 20% 400V (G, IT)	
C953	1-161-742-00	CERAMIC 0.0022uF 20% 400V (G, IT)	
< CONNECTOR >			
CN704	1-564-610-41	CONNECTOR, BOARD TO BOARD 10P	
CN705	1-564-610-41	CONNECTOR, BOARD TO BOARD 10P	
CN706	1-564-610-41	CONNECTOR, BOARD TO BOARD 10P	
CN902	* 1-564-687-11	PIN, CONNECTOR 3P	
CN952	* 1-564-321-00	PIN, CONNECTOR 2P	

Ref. No.	Part No.	Description	Remark
CNJ701	* 1-565-486-11	CONNECTOR, BOARD TO BOARD 10P	
CNJ702	* 1-565-486-11	CONNECTOR, BOARD TO BOARD 10P	
CNJ703	* 1-565-486-11	CONNECTOR, BOARD TO BOARD 10P	
CNJ707	* 1-565-486-11	CONNECTOR, BOARD TO BOARD 10P	
CNJ708	* 1-565-486-11	CONNECTOR, BOARD TO BOARD 10P	
CNJ709	* 1-565-486-11	CONNECTOR, BOARD TO BOARD 10P	
CNP707	1-508-693-00	CONNECTOR PIN 10P	
CNP708	1-508-693-00	CONNECTOR PIN 10P	
CNP709	1-508-693-00	CONNECTOR PIN 10P	
< DIODE >			
D651	8-719-913-37	DIODE GP-1A06 (PURE CIRCUIT)	
D701	8-719-304-52	DIODE SEL4825A-C	
D703	8-719-000-84	DIODE UZL-7M1	
< INDICATOR >			
FL701	1-519-558-11	INDICATOR TUBE, FLUORESCENT	
< IC >			
IC701	8-759-820-08	IC LC7570	
IC702	8-759-820-08	IC LC7570	
IC703	8-759-820-08	IC LC7570	
IC704	8-759-909-15	IC MSL915RS	
IC705	8-759-801-57	IC LB1494	
< TRANSISTOR >			
Q701	8-729-900-89	TRANSISTOR DTC144ES	
< RESISTOR >			
R651	1-249-417-11	CARBON 1K 5% 1/4W	
R652	1-249-417-11	CARBON 1K 5% 1/4W	
R653	1-249-409-11	CARBON 220 5% 1/4W	
R701	1-249-413-11	CARBON 470 5% 1/4W	
R702	1-249-405-11	CARBON 100 5% 1/4W	

DISPLAY

CONNECT(A)

CONNECT(B)

ENCODER

PGM SW

AC SW

AC CONNECTOR

TUNER

Ref. No.	Part No.	Description	Remark
R703	1-249-441-11	CARBON 100K 5% 1/4W	
R704	1-249-429-11	CARBON 10K 5% 1/4W	
R707	1-249-437-11	CARBON 47K 5% 1/4W	

< SWITCH >

S661	1-571-333-11	SWITCH, ROTARY (PROGRAM)	
S701	1-554-303-21	SWITCH, TACTILE (1)	
S702	1-554-303-21	SWITCH, TACTILE (2)	
S703	1-554-303-21	SWITCH, TACTILE (3)	
S704	1-554-303-21	SWITCH, TACTILE (4)	
S705	1-554-303-21	SWITCH, TACTILE (5)	
S706	1-554-303-21	SWITCH, TACTILE (6)	
S707	1-554-303-21	SWITCH, TACTILE (7)	
S708	1-554-303-21	SWITCH, TACTILE (8)	
S709	1-554-303-21	SWITCH, TACTILE (9)	
S710	1-554-303-21	SWITCH, TACTILE (0)	
S711	1-554-303-21	SWITCH, TACTILE (CALTONE)	
S712	1-554-303-21	SWITCH, TACTILE (ANT)	
S713	1-554-303-21	SWITCH, TACTILE (ANT ATT)	
S714	1-554-303-21	SWITCH, TACTILE (IF BAND)	
S715	1-554-303-21	SWITCH, TACTILE (MUTING)	
S716	1-554-303-21	SWITCH, TACTILE (FM MODE)	
S717	1-554-303-21	SWITCH, TACTILE (TUNE MODE)	
S718	1-554-303-21	SWITCH, TACTILE (CHARACTER)	
S719	1-554-303-21	SWITCH, TACTILE (BAND)	
S720	1-554-303-21	SWITCH, TACTILE (MEMORY)	
S721	1-554-303-21	SWITCH, TACTILE (PROGRAM CHECK)	
S722	1-554-303-21	SWITCH, TACTILE (TUNING/PRESET)	
S723	1-554-303-21	SWITCH, TACTILE (DISPLAY MODE)	
S724	1-554-303-21	SWITCH, TACTILE (SHIFT)	
S725	1-554-303-21	SWITCH, TACTILE (DISPLAY)	
S951	1-572-267-21	SWITCH, PUSH (AC POWER) (1 KEY)	

- * A-4345-296-A TUNER BOARD, COMPLETE (AEP, UK)
- * A-4345-297-A TUNER BOARD, COMPLETE (G)
- * A-4345-801-A TUNER BOARD, COMPLETE (IT)

- * 1-560-242-51 BUS BAR 7P
- * 1-560-242-61 BUS BAR 2P
- * 1-560-242-71 BUS BAR 6P
- * 1-560-242-91 BUS BAR 10P

- * 2-287-441-01 PLATE, SHIELD
- * 3-346-266-21 PLATE, GROUND
- * 4-911-325-01 PLATE (A), SHIELD
- * 4-921-402-01 HEAT SINK
- 7-682-548-09 SCREW +B 3X8

Ref. No.	Part No.	Description	Remark
< CAPACITOR >			
C104	1-162-195-31	CERAMIC 4.7PF 10% 50V	
C105	1-161-379-00	CERAMIC 0.01uF 20% 25V	
C107	1-101-004-00	CERAMIC 0.01uF 50V	
C109	1-162-196-31	CERAMIC 5.6PF 10% 50V	
C110	1-162-199-31	CERAMIC 10PF 5% 50V	
C111	1-162-282-31	CERAMIC 100PF 10% 50V	
C112	1-161-379-00	CERAMIC 0.01uF 20% 25V	
C113	1-124-907-11	ELECT 10uF 20% 50V	
C114	1-161-379-00	CERAMIC 0.01uF 20% 25V	
C115	1-162-195-31	CERAMIC 4.7PF 10% 50V	
C116	1-162-199-31	CERAMIC 10PF 5% 50V	
C117	1-162-206-31	CERAMIC 20PF 5% 50V	
C118	1-162-197-31	CERAMIC 6.8PF 10% 50V	
C119	1-101-004-00	CERAMIC 0.01uF 50V	
C120	1-162-191-31	CERAMIC 2.2PF 10% 50V	
C121	1-162-187-31	CERAMIC 1PF 20% 50V	
C122	1-161-379-00	CERAMIC 0.01uF 20% 25V	
C123	1-161-379-00	CERAMIC 0.01uF 20% 25V	
C124	1-124-119-00	ELECT 330uF 20% 16V	
C125	1-161-379-00	CERAMIC 0.01uF 30% 16V	
C126	1-161-379-00	CERAMIC 0.01uF 30% 16V	
C201	1-161-379-00	CERAMIC 0.01uF 20% 25V	
C202	1-161-379-00	CERAMIC 0.01uF 20% 25V	
C203	1-161-379-00	CERAMIC 0.01uF 20% 25V	
C204	1-161-379-00	CERAMIC 0.01uF 20% 25V	
C205	1-161-379-00	CERAMIC 0.01uF 20% 25V	
C206	1-161-379-00	CERAMIC 0.01uF 20% 25V	
C207	1-161-379-00	CERAMIC 0.01uF 20% 25V	
C208	1-161-379-00	CERAMIC 0.01uF 20% 25V	
C209	1-161-379-00	CERAMIC 0.01uF 20% 25V	
C210	1-161-379-00	CERAMIC 0.01uF 20% 25V	
C211	1-161-379-00	CERAMIC 0.01uF 20% 25V	
C212	1-162-195-31	CERAMIC 4.7PF 10% 50V	
C213	1-162-195-31	CERAMIC 4.7PF 10% 50V	
C214	1-161-379-00	CERAMIC 0.01uF 20% 25V	
C215	1-161-379-00	CERAMIC 0.01uF 20% 25V	
C220	1-161-379-00	CERAMIC 0.01uF 20% 25V	
C221	1-161-379-00	CERAMIC 0.01uF 20% 25V	
C222	1-161-379-00	CERAMIC 0.01uF 20% 25V	
C223	1-161-379-00	CERAMIC 0.01uF 20% 25V	
C224	1-161-379-00	CERAMIC 0.01uF 20% 25V	
C225	1-161-379-00	CERAMIC 0.01uF 20% 25V	
C226	1-161-379-00	CERAMIC 0.01uF 20% 25V	
C228	1-162-215-31	CERAMIC 47PF 5% 50V	
C231	1-161-379-00	CERAMIC 0.01uF 20% 25V	
C232	1-161-379-00	CERAMIC 0.01uF 20% 25V	

TUNER

Ref. No.	Part No.	Description	Remark			Ref. No.	Part No.	Description	Remark		
C233	1-161-379-00	CERAMIC	0.01uF	20%	25V	C310	1-124-252-00	ELECT	0.33uF	20%	50V
C241	1-162-199-31	CERAMIC	10PF	10%	50V	C311	1-124-463-00	ELECT	0.1uF	20%	50V
C242	1-161-379-00	CERAMIC	0.01uF	20%	25V	C312	1-124-902-00	ELECT	0.47uF	20%	50V
C243	1-161-379-00	CERAMIC	0.01uF	20%	25V	C313	1-104-271-11	POLYSTYRENE	750PF	5%	50V
C244	1-124-907-11	ELECT	10uF	20%	50V	C314	1-104-271-11	POLYSTYRENE	750PF	5%	50V
C251	1-161-379-00	CERAMIC	0.01uF	20%	25V	C315	1-102-953-00	CERAMIC	18PF	5%	50V
C252	1-161-379-00	CERAMIC	0.01uF	20%	25V	C316	1-102-953-00	CERAMIC	18PF	5%	50V
C253	1-161-379-00	CERAMIC	0.01uF	20%	25V	C317	1-124-997-11	ELECT	470uF	20%	10V
C254	1-124-925-11	ELECT	2.2uF	20%	100V	C318	1-126-026-11	ELECT	470uF	20%	25V
C255	1-124-925-11	ELECT	2.2uF	20%	100V	C319	1-130-475-00	MYLAR	0.0022uF	5%	50V
C256	1-161-379-00	CERAMIC	0.01uF	20%	25V	C320	1-130-475-00	MYLAR	0.0022uF	5%	50V
C257	1-161-379-00	CERAMIC	0.01uF	20%	25V	C321	1-126-023-11	ELECT	100uF	20%	25V
C258	1-126-026-11	ELECT	470uF	20%	25V	C322	1-126-023-11	ELECT	100uF	20%	25V
C259	1-161-379-00	CERAMIC	0.01uF	20%	25V	C323	1-126-025-11	ELECT	330uF	20%	25V
C260	1-161-379-00	CERAMIC	0.01uF	20%	25V	C324	1-124-929-11	ELECT	22uF	20%	100V
C261	1-161-379-00	CERAMIC	0.01uF	20%	25V	C325	1-124-929-11	ELECT	22uF	20%	100V
C262	1-161-379-00	CERAMIC	0.01uF	20%	25V	C326	1-136-166-00	FILM	0.12uF	5%	50V
C263	1-124-463-00	ELECT	0.1uF	20%	50V	C327	1-124-907-11	ELECT	10uF	20%	50V
C264	1-161-379-00	CERAMIC	0.01uF	20%	25V	C330	1-124-130-00	ELECT	100uF	20%	63V
C271	1-161-379-00	CERAMIC	0.01uF	20%	25V	C331	1-124-903-11	ELECT	1uF	20%	50V
C272	1-161-379-00	CERAMIC	0.01uF	20%	25V	C332	1-130-471-00	MYLAR	0.001uF	5%	50V (G, IT)
C273	1-161-379-00	CERAMIC	0.01uF	20%	25V	C333	1-130-471-00	MYLAR	0.001uF	5%	50V (G, IT)
C274	1-161-379-00	CERAMIC	0.01uF	20%	25V	C401	1-124-903-11	ELECT	1uF	20%	50V
C275	1-126-022-11	ELECT	47uF	20%	25V	C402	1-161-379-00	CERAMIC	0.01uF	20%	25V
C276	1-161-379-00	CERAMIC	0.01uF	20%	25V	C403	1-161-379-00	CERAMIC	0.01uF	20%	25V
C277	1-124-557-11	ELECT	1000uF	20%	25V	C404	1-161-379-00	CERAMIC	0.01uF	20%	25V
C278	1-161-379-00	CERAMIC	0.01uF	20%	25V	C405	1-124-477-11	ELECT	47uF	20%	25V
C279	1-126-025-11	ELECT	330uF	20%	25V	C406	1-161-379-00	CERAMIC	0.01uF	20%	25V
C280	1-130-471-00	MYLAR	0.001uF	5%	50V	C407	1-161-379-00	CERAMIC	0.01uF	20%	25V
C281	1-102-518-11	CERAMIC	33PF	5%	50V	C408	1-161-379-00	CERAMIC	0.01uF	20%	25V
C282	1-161-379-00	CERAMIC	0.01uF	20%	25V	C409	1-161-379-00	CERAMIC	0.01uF	20%	25V
C283	1-110-335-11	MYLAR	100PF	5%	50V	C410	1-123-382-00	ELECT	3.3uF	20%	100V
C284	1-130-467-00	MYLAR	470PF	5%	50V	C411	1-126-101-11	ELECT	100uF	20%	16V
C285	1-110-340-11	MYLAR	270PF	5%	50V	C412	1-161-379-00	CERAMIC	0.01uF	20%	25V
C286	1-110-340-11	MYLAR	270PF	5%	50V	C413	1-124-903-11	ELECT	1uF	20%	50V
C287	1-126-025-11	ELECT	330uF	20%	25V	C414	1-124-903-11	ELECT	1uF	20%	50V
C288	1-110-335-11	MYLAR	100PF	5%	50V (G, IT)	C415	1-124-927-11	ELECT	4.7uF	20%	100V
C288	1-130-475-00	MYLAR	0.0022uF	5%	50V (AEP, UK)	C416	1-161-379-00	CERAMIC	0.01uF	20%	25V
C289	1-126-025-11	ELECT	330uF	20%	25V	C417	1-162-294-31	CERAMIC	0.001uF	10%	50V
C301	1-124-902-00	ELECT	0.47uF	20%	50V	C418	1-162-215-31	CERAMIC	47PF	5%	50V
C302	1-124-903-11	ELECT	1uF	20%	50V	C419	1-161-379-00	CERAMIC	0.01uF	20%	25V
C303	1-136-161-00	FILM	0.047uF	5%	50V	C420	1-162-291-31	CERAMIC	560PF	10%	50V
C304	1-124-903-11	ELECT	1uF	20%	50V	C421	1-124-902-00	ELECT	0.47uF	20%	50V
C305	1-124-903-11	ELECT	1uF	20%	50V	C451	1-161-379-00	CERAMIC	0.01uF	20%	25V
C306	1-130-483-00	MYLAR	0.01uF	5%	50V	C452	1-161-379-00	CERAMIC	0.01uF	20%	25V
C307	1-124-902-00	ELECT	0.47uF	20%	50V	C453	1-161-374-11	CERAMIC	0.0015uF	20%	50V
C308	1-104-319-11	POLYSTYRENE	0.01uF	10%	50V	C454	1-161-374-11	CERAMIC	0.0015uF	20%	50V
C309	1-130-483-00	MYLAR	0.01uF	5%	50V	C455	1-161-379-00	CERAMIC	0.01uF	20%	25V
						C501	1-161-379-00	CERAMIC	0.01uF	20%	25V

TUNER

Ref. No.	Part No.	Description	Remark	Ref. No.	Part No.	Description	Remark
C502	1-102-959-00	CERAMIC	22PF 5% 50V			< FILTER >	
C503	1-102-959-00	CERAMIC	22PF 5% 50V				
C504	1-161-379-00	CERAMIC	0.01uF 20% 25V	CF201	1-567-389-11	FILTER, CERAMIC	
C505	1-161-379-00	CERAMIC	0.01uF 20% 25V	CF202	1-567-389-11	FILTER, CERAMIC	
C506	1-161-379-00	CERAMIC	0.01uF 20% 25V	CF203	1-567-389-11	FILTER, CERAMIC	
				CF204	1-567-107-71	FILTER, CERAMIC	
C507	1-161-379-00	CERAMIC	0.01uF 20% 25V				
C511	1-124-907-11	ELECT	10uF 20% 50V	CF301	1-567-250-11	OSCILLATOR, CERAMIC	
C512	1-124-907-11	ELECT	10uF 20% 50V	CF401	1-527-981-00	FILTER, CERAMIC	
C516	1-124-484-11	ELECT	220uF 20% 35V	CF402	1-527-826-00	FILTER, CERAMIC	
C521	1-126-059-11	ELECT	10uF 20% 50V	CF403	1-527-937-00	FILTER, CERAMIC	
						< CONNECTOR >	
C522	1-123-382-00	ELECT	3.3uF 20% 100V				
C523	1-124-254-00	ELECT	0.68uF 20% 50V	CN671 *	1-559-135-41	CORD (WITH CONNECTOR) 4P	
C524	1-124-463-00	ELECT	0.1uF 20% 50V	CN901 *	1-560-062-00	PIN, CONNECTOR 4P	
C551	1-126-059-11	ELECT	10uF 20% 50V				
C552	1-124-252-00	ELECT	0.33uF 20% 50V	CNJ301	1-563-560-11	JACK, PIN 2P	
C553	1-124-902-00	ELECT	0.47uF 20% 50V				
C554	1-130-483-00	MYLAR	0.01uF 5% 50V	CNP701 *	1-506-608-11	PIN, CONNECTOR 10P	
C601	1-123-382-00	ELECT	3.3uF 20% 100V	CNP702 *	1-506-608-11	PIN, CONNECTOR 10P	
C602	1-161-379-00	CERAMIC	0.01uF 20% 25V	CNP703 *	1-506-608-11	PIN, CONNECTOR 10P	
C603	1-161-379-00	CERAMIC	0.01uF 20% 25V	CNP704 *	1-564-338-00	PIN, CONNECTOR 4P	
				CNP705 *	1-564-337-00	PIN, CONNECTOR 3P	
C604	1-131-377-00	TANTALUM	10uF 10% 10V			< TRIMMER >	
C605	1-125-548-11	CAP, DOUBLE LAYERS	0.1F 5.5V	CT101	1-141-304-21	CAP, TRIMMER 10PF	
C606	1-161-379-00	CERAMIC	0.01uF 20% 25V	CT102	1-141-304-21	CAP, TRIMMER 10PF	
C607	1-161-379-00	CERAMIC	0.01uF 20% 25V	CT103	1-141-304-21	CAP, TRIMMER 10PF	
C901	1-101-004-00	CERAMIC	0.01uF 50V	CT271	1-141-232-00	CAP, TRIMMER	
						< DIODE >	
C902	1-101-004-00	CERAMIC	0.01uF 50V	D101	8-719-901-59	DIODE KV1320	
C903	1-101-004-00	CERAMIC	0.01uF 50V	D102	8-719-901-59	DIODE KV1320	
C904	1-101-004-00	CERAMIC	0.01uF 50V	D103	8-719-901-59	DIODE KV1320	
C905	1-125-578-11	ELECT	2200uF 20%	D104	8-719-901-59	DIODE KV1320	
C906	1-126-023-11	ELECT	100uF 20% 25V	D151	8-719-912-20	DIODE 1SS120	
C907	1-126-067-11	ELECT	1000uF 20% 63V	D152	8-719-912-20	DIODE 1SS120	
C910	1-130-789-00	FILM	1uF 5% 100V	D201	8-719-912-20	DIODE 1SS120	
C911	1-101-004-00	CERAMIC	0.01uF 50V	D202	8-719-912-20	DIODE 1SS120	
C912	1-101-004-00	CERAMIC	0.01uF 50V	D203	8-719-912-20	DIODE 1SS120	
C913	1-101-004-00	CERAMIC	0.01uF 50V	D241	8-719-022-21	DIODE 1T22A	
C914	1-101-004-00	CERAMIC	0.01uF 50V	D242	8-719-022-21	DIODE 1T22A	
C915	1-126-104-11	ELECT	470uF 20% 35V	D261	8-719-912-20	DIODE 1SS120	
C916	1-124-126-00	ELECT	47uF 20% 10V	D273	8-719-010-42	DIODE UZ-5.6BSB	
C917	1-126-101-11	ELECT	100uF 20% 16V	D274	8-719-010-42	DIODE UZ-5.6BSB	
C921	1-101-004-00	CERAMIC	0.01uF 50V	D275	8-719-936-88	DIODE SVC333-M1-SONY	
C922	1-124-920-11	ELECT	330uF 20% 50V	D276	8-719-912-20	DIODE 1SS120	
C923	1-126-051-11	ELECT	47uF 20% 50V	D277	8-719-912-20	DIODE 1SS120	
C924	1-126-051-11	ELECT	47uF 20% 50V	D278	8-719-912-20	DIODE 1SS120	
C931	1-101-004-00	CERAMIC	0.01uF 50V	D279	8-719-912-20	DIODE 1SS120	
C932	1-124-912-11	ELECT	330uF 20% 50V	D301	8-719-912-20	DIODE 1SS120	
C933	1-124-910-11	ELECT	47uF 20% 50V				
C934	1-124-910-11	ELECT	47uF 20% 50V				

TUNER

Ref. No.	Part No.	Description	Remark
D302	8-719-912-20	DIODE 1SS120	
D303	8-719-912-20	DIODE 1SS120	
D304	8-719-912-20	DIODE 1SS120	
D305	8-719-912-20	DIODE 1SS120	
D307	8-719-912-20	DIODE 1SS120	
D310	8-719-912-20	DIODE 1SS120	
D311	8-719-912-20	DIODE 1SS120	
D312	8-719-912-20	DIODE 1SS120	
D313	8-719-933-33	DIODE HZS-6A1L	
D401	8-719-912-20	DIODE 1SS120	
D402	8-719-912-20	DIODE 1SS120	
D511	8-719-933-33	DIODE HZS-6A1L	
D601	8-719-912-20	DIODE 1SS120	
D602	8-719-912-20	DIODE 1SS120	
D603	8-719-912-20	DIODE 1SS120	
D604	8-719-912-20	DIODE 1SS120	
D605	8-719-912-20	DIODE 1SS120	
D606	8-719-912-20	DIODE 1SS120	
D607	8-719-912-20	DIODE 1SS120	
D608	8-719-912-20	DIODE 1SS120	
D609	8-719-912-20	DIODE 1SS120	
D610	8-719-912-20	DIODE 1SS120	
D611	8-719-912-20	DIODE 1SS120	
D612	8-719-912-20	DIODE 1SS120	
D613	8-719-912-20	DIODE 1SS120	
D614	8-719-912-20	DIODE 1SS120	
D615	8-719-912-20	DIODE 1SS120	
D616	8-719-912-20	DIODE 1SS120	
D617	8-719-912-20	DIODE 1SS120	
D618	8-719-912-20	DIODE 1SS120	
D619	8-719-912-20	DIODE 1SS120	
D620	8-719-912-20	DIODE 1SS120	
D621	8-719-912-20	DIODE 1SS120	
D622	8-719-912-20	DIODE 1SS120	
D623	8-719-912-20	DIODE 1SS120	
D624	8-719-912-20	DIODE 1SS120	
D625	8-719-912-20	DIODE 1SS120	
D626	8-719-912-20	DIODE 1SS120	
D627	8-719-912-20	DIODE 1SS120	
D628	8-719-912-20	DIODE 1SS120 (EXCEPT 1T)	
D671	8-719-912-20	DIODE 1SS120	
D901	8-719-200-82	DIODE 11ES2	
D902	8-719-200-82	DIODE 11ES2	
D903	8-719-200-82	DIODE 11ES2	
D904	8-719-200-82	DIODE 11ES2	
D905	8-719-933-33	DIODE HZS-6A1L	
D911	8-719-200-82	DIODE 11ES2	
D912	8-719-200-82	DIODE 11ES2	
D913	8-719-200-82	DIODE 11ES2	

Ref. No.	Part No.	Description	Remark
D914	8-719-200-82	DIODE 11ES2	
D921	8-719-200-82	DIODE 11ES2	
D922	8-719-934-22	DIODE HZS30-2L	
D931	8-719-200-82	DIODE 11ES2	
D932	8-719-002-06	DIODE HZL-18L	
< ENCAPSULATED COMPONENT >			
FE401	1-236-559-11	ENCAPSULATED COMPONENT (MW RF)	
FE451	1-239-043-11	ENCAPSULATED COMPONENT (LW RF)	
< IC >			
IC201	8-759-111-72	IC μ PC1163HA	
IC202	8-759-111-72	IC μ PC1163HA	
IC251	8-759-812-35	IC LA1235	
IC271	8-759-111-72	IC μ PC1163HA	
IC272	8-759-602-01	IC M5220P	
IC301	8-759-802-57	IC CXA1064S	
IC401	8-759-812-45	IC LA1245	
IC501	8-757-925-20	IC CX-7925B	
IC601	8-759-055-60	IC μ PD75108CW-C79	
IC602	8-759-140-11	IC MC14011BC	
IC911	8-759-820-09	IC LA5667	
< COIL >			
I FT101	1-404-666-11	COIL, FM IFT	
I FT201	1-404-665-11	COIL, FM IFT (2)	
I FT202	1-404-665-11	COIL, FM IFT (2)	
I FT203	1-404-665-11	COIL, FM IFT (2)	
I FT204	1-404-665-11	COIL, FM IFT (2)	
I FT251	1-404-669-11	COIL, DISCRIMINATOR	
I FT271	1-404-668-11	COIL, FM DET (1)	
I FT272	1-404-667-11	COIL, FM DET (2)	
I FT401	1-404-326-00	TRANSFORMER, IF	
< COIL >			
L101	1-402-240-11	COIL (ANT)	
L102	1-426-249-11	COIL (RF)	
L103	1-459-647-11	COIL (WITH CORE)	
L104	1-459-618-11	COIL	
L105	1-410-967-11	INDUCTOR	2.2 μ H
L106	1-410-501-11	INDUCTOR	2.2 μ H
L107	1-408-988-21	INDUCTOR	390 μ H
L108	1-410-977-11	INDUCTOR	100 μ H
L201	1-410-977-11	INDUCTOR	100 μ H
L202	1-410-977-11	INDUCTOR	100 μ H
L203	1-410-977-11	INDUCTOR	100 μ H
L251	1-410-781-11	INDUCTOR	33mH
L252	1-410-781-11	INDUCTOR	33mH
L271	1-410-978-11	INDUCTOR	150 μ H

TUNER

Ref. No.	Part No.	Description	Remark	Ref. No.	Part No.	Description	Remark
L301	1-409-413-11	COIL (TUNING)		Q305	8-729-201-56	TRANSISTOR	2SK246-GR2
L302	1-410-971-11	INDUCTOR	10uH (G, IT)	Q306	8-729-201-56	TRANSISTOR	2SK246-GR2
L303	1-410-971-11	INDUCTOR	10uH (G, IT)	Q308	8-729-141-30	TRANSISTOR	2SC3623A-LK
L451	1-410-979-11	INDUCTOR	220uH	Q309	8-729-141-30	TRANSISTOR	2SC3623A-LK
L452	1-410-977-11	INDUCTOR	100uH	Q310	8-729-900-65	TRANSISTOR	DTA144ES
< FILTER >				Q401	8-729-900-89	TRANSISTOR	DTC144ES
LPF201	1-235-892-11	FILTER, LOW PASS (G, IT)		Q402	8-729-904-39	TRANSISTOR	DTC114TS
LPF301	1-236-560-11	ENCAPSULATED COMPONENT (LPF)		Q403	8-729-620-05	TRANSISTOR	2SC2603-EF
< TRANSISTOR >				Q404	8-729-620-05	TRANSISTOR	2SC2603-EF
Q101	8-729-200-55	TRANSISTOR	2SK241-Y	Q405	8-729-904-39	TRANSISTOR	DTC114TS
Q102	8-729-144-76	TRANSISTOR	3SK122K	Q406	8-729-806-24	TRANSISTOR	2SC3899
Q103	8-729-216-13	TRANSISTOR	2SK161-GR	Q407	8-729-201-56	TRANSISTOR	2SK246-GR2
Q104	8-729-216-13	TRANSISTOR	2SK161-GR	Q408	8-729-806-24	TRANSISTOR	2SC3899
Q105	8-729-216-13	TRANSISTOR	2SK161-GR	Q451	8-729-216-13	TRANSISTOR	2SK161-GR
Q151	8-729-904-39	TRANSISTOR	DTC114TS	Q452	8-729-216-13	TRANSISTOR	2SK161-GR
Q152	8-729-904-39	TRANSISTOR	DTC114TS	Q453	8-729-900-89	TRANSISTOR	DTC144ES
Q201	8-729-800-43	TRANSISTOR	2SK152-3	Q454	8-729-900-89	TRANSISTOR	DTC144ES
Q202	8-729-904-39	TRANSISTOR	DTC114TS	Q455	8-729-900-89	TRANSISTOR	DTC144ES
Q203	8-729-904-39	TRANSISTOR	DTC114TS	Q456	8-729-141-32	TRANSISTOR	2SA1409TP-LK
Q204	8-729-904-39	TRANSISTOR	DTC114TS	Q457	8-729-141-30	TRANSISTOR	2SC3623A-LK
Q205	8-729-904-39	TRANSISTOR	DTC114TS	Q458	8-729-900-89	TRANSISTOR	DTC144ES
Q206	8-729-904-39	TRANSISTOR	DTC114TS	Q459	8-729-900-89	TRANSISTOR	DTC144ES
Q207	8-729-904-39	TRANSISTOR	DTC114TS	Q501	8-729-900-89	TRANSISTOR	DTC144ES
Q208	8-729-904-39	TRANSISTOR	DTC114TS	Q502	8-729-119-76	TRANSISTOR	2SA1175-HFE
Q211	8-729-200-55	TRANSISTOR	2SK241-Y	Q503	8-729-620-05	TRANSISTOR	2SC2603-EF
Q212	8-729-900-89	TRANSISTOR	DTC144ES	Q511	8-729-620-05	TRANSISTOR	2SC2603-EF
Q213	8-729-230-XX	TRANSISTOR	2SC2669-OY	Q521	8-729-203-05	TRANSISTOR	2SK30A-GR3
Q215	8-729-230-XX	TRANSISTOR	2SC2669-OY	Q522	8-729-119-78	TRANSISTOR	2SC2785-HFE
Q216	8-729-230-XX	TRANSISTOR	2SC2669-OY	Q551	8-729-203-05	TRANSISTOR	2SK30A-GR3
Q231	8-729-900-89	TRANSISTOR	DTC144ES	Q552	8-729-119-78	TRANSISTOR	2SC2785-HFE
Q232	8-729-904-39	TRANSISTOR	DTC114TS	Q601	8-729-620-05	TRANSISTOR	2SC2603-EF
Q233	8-729-904-39	TRANSISTOR	DTC114TS	Q603	8-729-620-05	TRANSISTOR	2SC2603-EF
Q234	8-729-900-65	TRANSISTOR	DTA144ES	Q671	8-729-900-89	TRANSISTOR	DTC144ES
Q235	8-729-900-89	TRANSISTOR	DTC144ES	Q901	8-729-127-53	TRANSISTOR	2SC2275-P
Q241	8-729-230-XX	TRANSISTOR	2SC2669-OY	Q902	8-729-281-53	TRANSISTOR	2SC1815-GR
Q251	8-729-201-56	TRANSISTOR	2SK246-GR2	Q903	8-729-281-53	TRANSISTOR	2SC1815-GR
Q252	8-729-900-89	TRANSISTOR	DTC144ES	Q904	8-729-201-56	TRANSISTOR	2SK246-GR2
Q253	8-729-620-05	TRANSISTOR	2SC2603-EF	Q921	8-729-140-96	TRANSISTOR	2SD774-34
Q254	8-729-900-89	TRANSISTOR	DTC144ES	Q931	8-729-140-97	TRANSISTOR	2SB734-34
Q255	8-729-806-24	TRANSISTOR	2SC3899	< RESISTOR >			
Q256	8-729-900-89	TRANSISTOR	DTC144ES	R101	1-249-437-11	CARBON	47K 5% 1/4W
Q271	8-729-802-43	TRANSISTOR	2SK125-3	R102	1-249-437-11	CARBON	47K 5% 1/4W
Q272	8-729-201-56	TRANSISTOR	2SK246-GR2	R103	1-249-437-11	CARBON	47K 5% 1/4W
Q301	8-729-806-24	TRANSISTOR	2SC3899	R104	1-249-405-11	CARBON	100 5% 1/4W
Q302	8-729-900-89	TRANSISTOR	DTC144ES	R105	1-249-437-11	CARBON	47K 5% 1/4W
Q303	8-729-900-89	TRANSISTOR	DTC144ES	R106	1-249-437-11	CARBON	47K 5% 1/4W
Q304	8-729-900-65	TRANSISTOR	DTA144ES	R107	1-249-399-11	CARBON	33 5% 1/4W
				R108	1-249-441-11	CARBON	100K 5% 1/4W

TUNER

Ref. No.	Part No.	Description			Remark
R109	1-249-441-11	CARBON	100K	5%	1/4W
R110	1-249-441-11	CARBON	100K	5%	1/4W
R111	1-249-405-11	CARBON	100	5%	1/4W
R112	1-249-405-11	CARBON	100	5%	1/4W
R114	1-249-431-11	CARBON	15K	5%	1/4W
R115	1-249-437-11	CARBON	47K	5%	1/4W
R116	1-249-405-11	CARBON	100	5%	1/4W
R117	1-249-411-11	CARBON	330	5%	1/4W
R118	1-249-437-11	CARBON	47K	5%	1/4W
R119	1-249-405-11	CARBON	100	5%	1/4W
R151	1-249-721-11	CARBON	100K	5%	1/2W
R152	1-249-721-11	CARBON	100K	5%	1/2W
R153	1-249-404-00	CARBON	82	5%	1/4W
R154	1-249-404-00	CARBON	82	5%	1/4W
R155	1-249-398-11	CARBON	27	5%	1/4W
R156	1-247-800-11	CARBON	51	5%	1/4W
R157	1-247-800-11	CARBON	51	5%	1/4W
R201	1-249-411-11	CARBON	330	5%	1/4W
R202	1-249-411-11	CARBON	330	5%	1/4W
R203	△ 1-212-857-00	FUSIBLE	10	5%	1/4W F
R204	1-249-411-11	CARBON	330	5%	1/4W
R205	1-249-405-11	CARBON	100	5%	1/4W
R206	1-249-411-11	CARBON	330	5%	1/4W
R207	△ 1-212-857-00	FUSIBLE	10	5%	1/4W F
R208	1-249-411-11	CARBON	330	5%	1/4W
R209	1-249-405-11	CARBON	100	5%	1/4W
R210	1-249-413-11	CARBON	470	5%	1/4W
R211	△ 1-212-857-00	FUSIBLE	10	5%	1/4W F
R212	1-249-422-11	CARBON	2.7K	5%	1/4W
R213	1-249-422-11	CARBON	2.7K	5%	1/4W
R217	1-249-411-11	CARBON	330	5%	1/4W
R218	1-249-409-11	CARBON	220	5%	1/4W
R219	1-249-405-11	CARBON	100	5%	1/4W
R220	1-249-411-11	CARBON	330	5%	1/4W
R221	1-249-395-11	CARBON	15	5%	1/4W
R222	1-249-409-11	CARBON	220	5%	1/4W
R223	1-249-441-11	CARBON	100K	5%	1/4W
R224	1-249-411-11	CARBON	330	5%	1/4W
R225	1-249-429-11	CARBON	10K	5%	1/4W
R226	1-249-434-11	CARBON	27K	5%	1/4W
R227	△ 1-212-857-00	FUSIBLE	10	5%	1/4W F
R228	1-249-417-11	CARBON	1K	5%	1/4W
R229	1-249-431-11	CARBON	15K	5%	1/4W
R230	1-249-434-11	CARBON	27K	5%	1/4W
R231	1-249-428-11	CARBON	8.2K	5%	1/4W
R232	1-249-429-11	CARBON	10K	5%	1/4W
R233	1-249-429-11	CARBON	10K	5%	1/4W
R234	1-249-429-11	CARBON	10K	5%	1/4W
R241	1-247-895-00	CARBON	470K	5%	1/4W

Ref. No.	Part No.	Description			Remark
R242	1-249-417-11	CARBON	1K	5%	1/4W
R243	1-249-437-11	CARBON	47K	5%	1/4W
R244	1-249-437-11	CARBON	47K	5%	1/4W
R251	1-249-411-11	CARBON	330	5%	1/4W
R252	1-249-441-11	CARBON	100K	5%	1/4W
R253	1-249-432-11	CARBON	18K	5%	1/4W
R254	1-247-903-00	CARBON	1M	5%	1/4W
R255	1-249-434-11	CARBON	27K	5%	1/4W
R256	1-249-430-11	CARBON	12K	5%	1/4W
R257	1-249-417-11	CARBON	1K	5%	1/4W
R258	1-249-425-11	CARBON	4.7K	5%	1/4W
R259	△ 1-212-881-11	FUSIBLE	100	5%	1/4W F
R260	1-249-438-11	CARBON	56K	5%	1/4W
R261	1-249-441-11	CARBON	100K	5%	1/4W
R262	1-249-437-11	CARBON	47K	5%	1/4W
R263	1-249-437-11	CARBON	47K	5%	1/4W
R264	1-249-433-11	CARBON	22K	5%	1/4W
R265	1-249-437-11	CARBON	47K	5%	1/4W
R266	1-249-437-11	CARBON	47K	5%	1/4W
R271	1-249-421-11	CARBON	2.2K	5%	1/4W
R272	1-249-411-11	CARBON	330	5%	1/4W
R273	1-249-417-11	CARBON	1K	5%	1/4W
R274	△ 1-212-857-00	FUSIBLE	10	5%	1/4W F
R275	1-249-417-11	CARBON	1K	5%	1/4W
R276	1-249-417-11	CARBON	1K	5%	1/4W
R277	1-249-417-11	CARBON	1K	5%	1/4W
R278	1-249-417-11	CARBON	1K	5%	1/4W
R279	△ 1-212-881-11	FUSIBLE	100	5%	1/4W F
R280	1-249-441-11	CARBON	100K	5%	1/4W
R281	1-249-409-11	CARBON	220	5%	1/4W
R282	1-249-410-11	CARBON	270	5%	1/4W
R283	1-249-417-11	CARBON	1K	5%	1/4W
R284	1-249-434-11	CARBON	27K	5%	1/4W
R285	1-249-429-11	CARBON	10K	5%	1/4W
R286	1-249-429-11	CARBON	10K	5%	1/4W
R287	1-249-422-11	CARBON	2.7K	5%	1/4W
R288	1-249-413-11	CARBON	470	5%	1/4W
R289	1-247-903-00	CARBON	1M	5%	1/4W
R290	1-249-417-11	CARBON	1K	5%	1/4W (AEP, UK)
R291	1-249-418-11	CARBON	1.2K	5%	1/4W (AEP, UK)
R291	1-249-434-11	CARBON	27K	5%	1/4W (G, IT)
R293	1-249-426-11	CARBON	5.6K	5%	1/4W (G, IT)
R294	1-249-432-11	CARBON	18K	5%	1/4W (G, IT)
R292	△ 1-212-881-11	FUSIBLE	100	5%	1/4W F
R301	△ 1-212-857-00	FUSIBLE	10	5%	1/4W F
R302	1-249-423-11	CARBON	3.3K	5%	1/4W

The components identified by mark △ or dotted line with mark △ are critical for safety. Replace only with part number specified.

TUNER

Ref. No.	Part No.	Description	Remark			Ref. No.	Part No.	Description	Remark		
R303	1-249-431-11	CARBON	15K	5%	1/4W	R454	1-249-433-11	CARBON	22K	5%	1/4W
R304	1-249-427-11	CARBON	6.8K	5%	1/4W	R455	1-249-433-11	CARBON	22K	5%	1/4W
R305	1-249-426-11	CARBON	5.6K	5%	1/4W	R456	1-247-903-00	CARBON	1M	5%	1/4W
R306	1-249-441-11	CARBON	100K	5%	1/4W	R457	1-249-429-11	CARBON	10K	5%	1/4W
R307	1-247-886-11	CARBON	200K	5%	1/4W	R501	1-249-429-11	CARBON	10K	5%	1/4W
R308	1-249-441-11	CARBON	100K	5%	1/4W	R502	1-249-429-11	CARBON	10K	5%	1/4W
R309	1-247-886-11	CARBON	200K	5%	1/4W	R503	1-249-429-11	CARBON	10K	5%	1/4W
R310	1-247-887-00	CARBON	220K	5%	1/4W	R504	1-249-423-11	CARBON	3.3K	5%	1/4W
R311	1-247-887-00	CARBON	220K	5%	1/4W	R505	1-249-433-11	CARBON	22K	5%	1/4W
R312	1-249-399-11	CARBON	33	5%	1/4W	R511	△ 1-212-889-00	FUSIBLE	220	5%	1/4W F
R313	1-249-399-11	CARBON	33	5%	1/4W	R512	1-249-421-11	CARBON	2.2K	5%	1/4W
R314	1-249-417-11	CARBON	1K	5%	1/4W	R516	△ 1-217-402-00	FUSIBLE	180	5%	1/4W F
R315	1-249-417-11	CARBON	1K	5%	1/4W	R521	1-249-414-11	CARBON	560	5%	1/4W
R316	1-249-437-11	CARBON	47K	5%	1/4W	R522	1-249-414-11	CARBON	560	5%	1/4W
R317	1-249-437-11	CARBON	47K	5%	1/4W	R523	1-249-418-11	CARBON	1.2K	5%	1/4W
R318	1-249-429-11	CARBON	10K	5%	1/4W	R524	1-249-411-11	CARBON	330	5%	1/4W
R319	1-247-903-00	CARBON	1M	5%	1/4W	R525	1-249-420-11	CARBON	1.8K	5%	1/4W
R320	1-247-903-00	CARBON	1M	5%	1/4W	R526	1-249-427-11	CARBON	6.8K	5%	1/4W
R321	1-249-429-11	CARBON	10K	5%	1/4W	R527	1-249-425-11	CARBON	4.7K	5%	1/4W
R322	1-249-429-11	CARBON	10K	5%	1/4W	R528	1-249-417-11	CARBON	1K	5%	1/4W
R323	1-249-417-11	CARBON	1K	5%	1/4W	R529	1-249-415-11	CARBON	680	5%	1/4W
R324	1-249-417-11	CARBON	1K	5%	1/4W	R530	1-249-425-11	CARBON	4.7K	5%	1/4W
R325	1-249-405-11	CARBON	100	5%	1/4W	R551	1-249-429-11	CARBON	10K	5%	1/4W
R327	△ 1-212-873-11	FUSIBLE	47	5%	1/4W F	R552	1-249-414-11	CARBON	560	5%	1/4W
R328	1-249-429-11	CARBON	10K	5%	1/4W	R553	1-249-418-11	CARBON	1.2K	5%	1/4W
R329	1-249-436-11	CARBON	39K	5%	1/4W	R554	1-249-411-11	CARBON	330	5%	1/4W
R401	1-249-429-11	CARBON	10K	5%	1/4W	R555	1-249-441-11	CARBON	100K	5%	1/4W
R402	1-249-421-11	CARBON	2.2K	5%	1/4W	R556	1-249-427-11	CARBON	6.8K	5%	1/4W
R403	△ 1-212-889-00	FUSIBLE	220	5%	1/4W F	R557	1-249-425-11	CARBON	4.7K	5%	1/4W
R404	1-249-413-11	CARBON	470	5%	1/4W	R601	1-249-433-11	CARBON	22K	5%	1/4W
R405	1-249-429-11	CARBON	10K	5%	1/4W	R602	1-249-433-11	CARBON	22K	5%	1/4W
R406	1-249-429-11	CARBON	10K	5%	1/4W	R603	1-249-433-11	CARBON	22K	5%	1/4W
R407	1-249-405-11	CARBON	100	5%	1/4W	R604	1-249-437-11	CARBON	47K	5%	1/4W
R408	1-249-404-00	CARBON	82	5%	1/4W	R605	1-249-437-11	CARBON	47K	5%	1/4W
R409	1-249-424-11	CARBON	3.9K	5%	1/4W	R606	1-249-437-11	CARBON	47K	5%	1/4W
R410	△ 1-212-885-00	FUSIBLE	150	5%	1/4W F	R607	1-249-437-11	CARBON	47K	5%	1/4W
R411	1-249-422-11	CARBON	2.7K	5%	1/4W	R608	1-249-429-11	CARBON	10K	5%	1/4W
R412	1-249-429-11	CARBON	10K	5%	1/4W	R609	1-249-429-11	CARBON	10K	5%	1/4W
R413	1-249-441-11	CARBON	100K	5%	1/4W	R610	1-249-429-11	CARBON	10K	5%	1/4W
R414	1-249-430-11	CARBON	12K	5%	1/4W	R611	1-249-429-11	CARBON	10K	5%	1/4W
R415	1-249-430-11	CARBON	12K	5%	1/4W	R612	1-249-429-11	CARBON	10K	5%	1/4W
R416	1-249-422-11	CARBON	2.7K	5%	1/4W	R613	1-249-429-11	CARBON	10K	5%	1/4W
R417	1-249-426-11	CARBON	5.6K	5%	1/4W	R614	1-249-437-11	CARBON	47K	5%	1/4W
R418	1-249-433-11	CARBON	22K	5%	1/4W	R615	1-249-429-11	CARBON	10K	5%	1/4W
R419	1-249-429-11	CARBON	10K	5%	1/4W	R616	1-249-433-11	CARBON	22K	5%	1/4W
R420	1-247-903-00	CARBON	1M	5%	1/4W	R617	1-249-433-11	CARBON	22K	5%	1/4W
R451	1-249-441-11	CARBON	100K	5%	1/4W	R618	1-249-433-11	CARBON	22K	5%	1/4W
R452	1-249-421-11	CARBON	2.2K	5%	1/4W	R619	1-249-433-11	CARBON	22K	5%	1/4W
R453	1-249-417-11	CARBON	1K	5%	1/4W	R620	1-249-429-11	CARBON	10K	5%	1/4W

The components identified by mark △ or dotted line with mark △ are critical for safety.
Replace only with part number specified.

TUNER

Ref. No.	Part No.	Description	Remark
R621	1-249-429-11	CARBON	10K 5% 1/4W
R622	1-249-429-11	CARBON	10K 5% 1/4W
R623	1-249-429-11	CARBON	10K 5% 1/4W
R624	1-247-895-00	CARBON	470K 5% 1/4W
R625	1-249-433-11	CARBON	22K 5% 1/4W
R626	△ 1-212-873-11	FUSIBLE	47 5% 1/4W F
R627	1-249-417-11	CARBON	1K 5% 1/4W
R629	1-247-883-00	CARBON	150K 5% 1/4W
R630	1-249-433-11	CARBON	22K 5% 1/4W
R631	1-249-429-11	CARBON	10K 5% 1/4W
R671	1-249-410-11	CARBON	270 5% 1/4W
R672	1-249-393-11	CARBON	10 5% 1/4W
R673	1-249-437-11	CARBON	47K 5% 1/4W
R674	1-249-429-11	CARBON	10K 5% 1/4W
R903	1-249-409-11	CARBON	220 5% 1/4W
R904	1-249-429-11	CARBON	10K 5% 1/4W
R905	1-249-427-11	CARBON	6.8K 5% 1/4W
R910	△ 1-212-865-00	FUSIBLE	22 5% 1/4W F
R911	1-249-437-11	CARBON	47K 5% 1/4W
R921	△ 1-212-889-00	FUSIBLE	220 5% 1/4W F
R922	1-249-424-11	CARBON	3.9K 5% 1/4W
R931	△ 1-217-497-00	FUSIBLE	220 5% 1W F
R932	1-249-425-11	CARBON	4.7K 5% 1/4W
R933	1-247-883-00	CARBON	150K 5% 1/4W
R934	1-249-440-11	CARBON	82K 5% 1/4W
< VARIABLE RESISTOR >			
RV201	1-237-460-11	RES. ADJ. CARBON	20K
RV202	1-237-460-11	RES. ADJ. CARBON	20K
RV203	1-237-458-21	RES. ADJ. CARBON	5K
RV204	1-237-455-11	RES. ADJ. CARBON	500
RV241	1-237-463-11	RES. ADJ. CARBON	200K
RV251	1-237-459-11	RES. ADJ. CARBON	10K
RV252	1-237-463-11	RES. ADJ. CARBON	200K
RV301	1-237-465-11	RES. ADJ. CARBON	1M
RV302	1-237-465-11	RES. ADJ. CARBON	1M
RV303	1-237-461-11	RES. ADJ. CARBON	50K
RV401	1-237-463-11	RES. ADJ. CARBON	200K
< RELAY >			
RY151	1-515-614-11	RELAY	
RY152	1-515-614-11	RELAY	
RY153	1-515-614-11	RELAY	
< THERMISTOR >			
TH201	1-807-970-11	THERMISTOR	150
TH202	1-808-269-11	THERMISTOR	250
TH203	1-808-269-11	THERMISTOR	250
TH271	1-807-972-11	THERMISTOR	1250

Ref. No.	Part No.	Description	Remark
< TERMINAL >			
TM101	1-537-352-11	TERMINAL BOARD	
< TEST PIN >			
TP201	* 1-565-513-11	PIN. CONNECTOR	2P
TP271	* 1-565-513-11	PIN. CONNECTOR	2P
TP602	* 1-565-513-11	PIN. CONNECTOR	2P
< VIBRATOR, CRYSTAL >			
XT501	1-567-826-21	VIBRATOR, CRYSTAL	
XT601	1-577-359-21	VIBRATOR, CERAMIC	

MISCELLANEOUS			

5	1-452-419-21	MAGNET	
78	△ 1-574-383-11	CORD, POWER (AEP)	
78	△ 1-574-384-11	CORD, POWER (UK)	
PT901	△ 1-450-409-11	TRANSFORMER, POWER	
S951	△ 1-572-267-11	SWITCH, PUSH (AC POWER)	(1 KEY)

ACCESSORIES & PACKING MATERIALS			

1-417-090-00 TRANSFORMER, ANTENNA MATCHING			
1-501-224-00 ANTENNA, FEEDER			
1-501-451-11 ANTENNA, LOOP			
1-558-233-11 CORD (WITH CONNECTOR) (SIRCS) 4P			
1-559-533-11 CORD, CONNECTION			
3-704-366-01 SCREW (CASE) (M3X8) ... (BLACK)			
3-704-366-11 SCREW (CASE) (M3X8) ... (GOLD)			
3-753-233-11 MANUAL, INSTRUCTION (AEP, UK, IT)			
(ENGLISH, FRENCH, SPANISH, ITALIAN)			
3-753-233-41 MANUAL, INSTRUCTION (AEP, G.)			
(GERMAN, DUTCH, SWEDISH, PORTUGUESE)			
* 4-923-472-01 CUSHION			
* 4-926-284-31 INDIVIDUAL CARTON			

HARDWARE LIST			

#1	7-682-547-09	SCREW +BV 3X6, S TIGHT	
#2	7-682-548-09	SCREW +B 3X8	
#3	7-682-549-09	SCREW +BVTT 3X10 (S)	
#4	7-682-560-09	SCREW +BVTT 4X6 (S)	
#5	7-685-883-09	SCREW +BVTT 4X12 (S)	

The components identified by mark △ or dotted line with mark △ are critical for safety. Replace only with part number specified.