

HiFi ENGINE®

For more Hi-Fi manuals and set-up information
please visit www.hifiengine.com

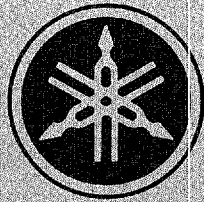

YAMAHA

FM STEREO TUNER

T-2

OWNER'S MANUAL

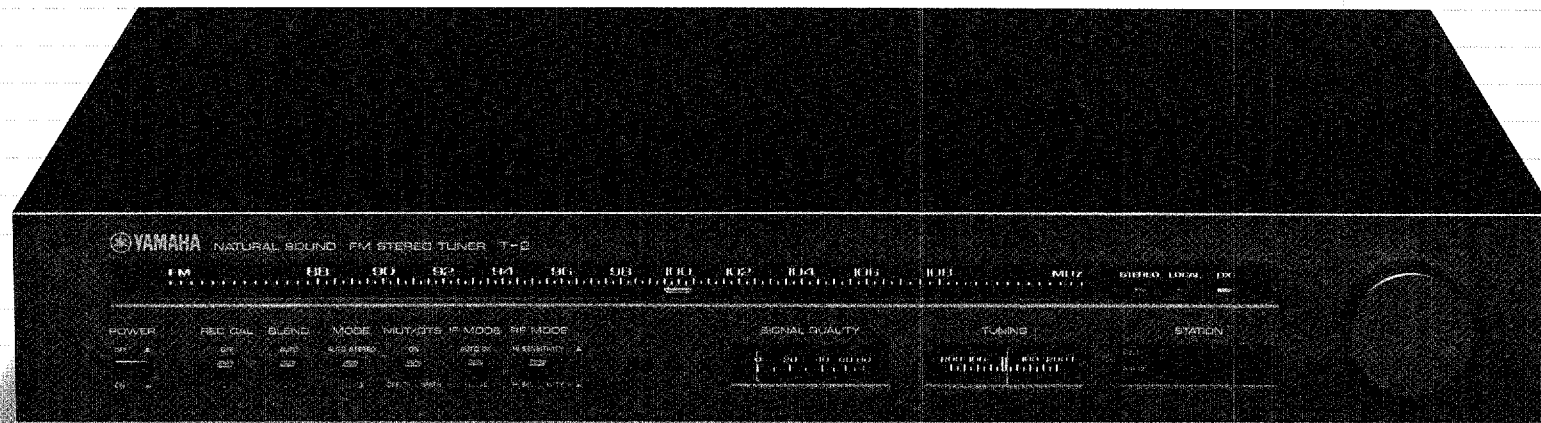

CENTER

U/C

Thank you for your purchase of this new Yamaha T-2 FM Stereo Tuner. You will find it to be the product of the most sophisticated Yamaha research and technology which continually attempts to make the best possible audio performance available to the widest range of enthusiasts. To make the most of the outstanding performance features of this tuner, you are encouraged to thoroughly familiarize yourself with the operating instructions in these pages.

Features

- Dual Gate MOS FET and FM 7-gang Frequency Linear Variable Capacitor are used for the front-end. RF MODE Switching-over Circuit provided on the RF stage delivers high sensitivity reception and excellent interference suppression characteristics.
- Signal Meter of the interference wave detection type displays existence of such wave and multipath.
- Timing Circuit is provided to deliver muting function which eliminates shock noise when the power switch is turned ON/OFF.
- Station Indicator equipped performs digital display of the frequency of a station as it is tuned in.
- AUTO DX Circuit is equipped, which detects "quality" of received signals and automatically switches over IF ranges so as to make high quality reception possible, i.e., it automatically switches over to LOCAL MODE to deliver excellent audio characteristics (low distortion, wide range) in case of reception with comparatively less interference, and to DX MODE to efficiently cut interference and perform high sensitivity reception when wave is weak with strong interference.
- MPX Circuit is exclusively Yamaha's DC NFB SWITCHING circuit depending on High-Slew-Rate DC amplifier. 19 kHz pilot signals are completely canceled as they become unnecessary so that high frequency characteristics are extensively improved (flat at up to 18 kHz or thereabouts).

Contents

Caution; Read this Before Operating	
Your T-2	3
Connection Diagram	4
Connections	5
The Names and Functions of Components	6
Broadcast Reception	8
IF MODE Switch	9
REC CAL Switch	10
Multipath Detection	10
Circuit Explanation	11
Performance Graphs	14
Specifications	16
Block Diagram	17
Schematic Diagram	18
Trouble shooting	19

IMPORTANT!

Please record the serial number of your unit in the space below

Model Name T-2

Serial No. _____

The serial number is located on the rear of the chassis.

Retain this Owner's Manual in a safe place for future reference.

T-2

CAUTION; READ THIS BEFORE OPERATING YOUR T-2

1

The T-2 is a high performance FM stereo tuner with excellent selectivity, sensitivity, and several special features. This manual is required reading if you are to get the best from it.

2

Do not drop or otherwise jar the T-2 which is precision instrument.

3

Do not place the T-2 where it will be exposed to direct sunlight, excessive heat (for instance over a radiator or on top of an amplifier which generates a fair amount of heat), moisture, or dust.

4

Do not use chemical solvents (such as benzene or alcohol) to remove traces of dirt. Wipe only with a soft, slightly damp cloth.

5

Do not attempt to carry out internal adjustments or repairs. Leave this to your local service representative.

6

Do not assume your T-2 is faulty before checking the 'Trouble Shooting' list on page 19 for common operating errors.

7

Operate all switches and knobs in accordance with the instructions. Avoid applying undue force, which should never be necessary, and do not attempt to use intermediate settings.

8

Keep this manual in a safe place for future reference, and refer to it frequently until you are perfectly familiar with all T-2 controls and functions.

Warning — to prevent fire or shock hazard, do not expose this appliance to rain or moisture.

T-2

CONNECTION DIAGRAM

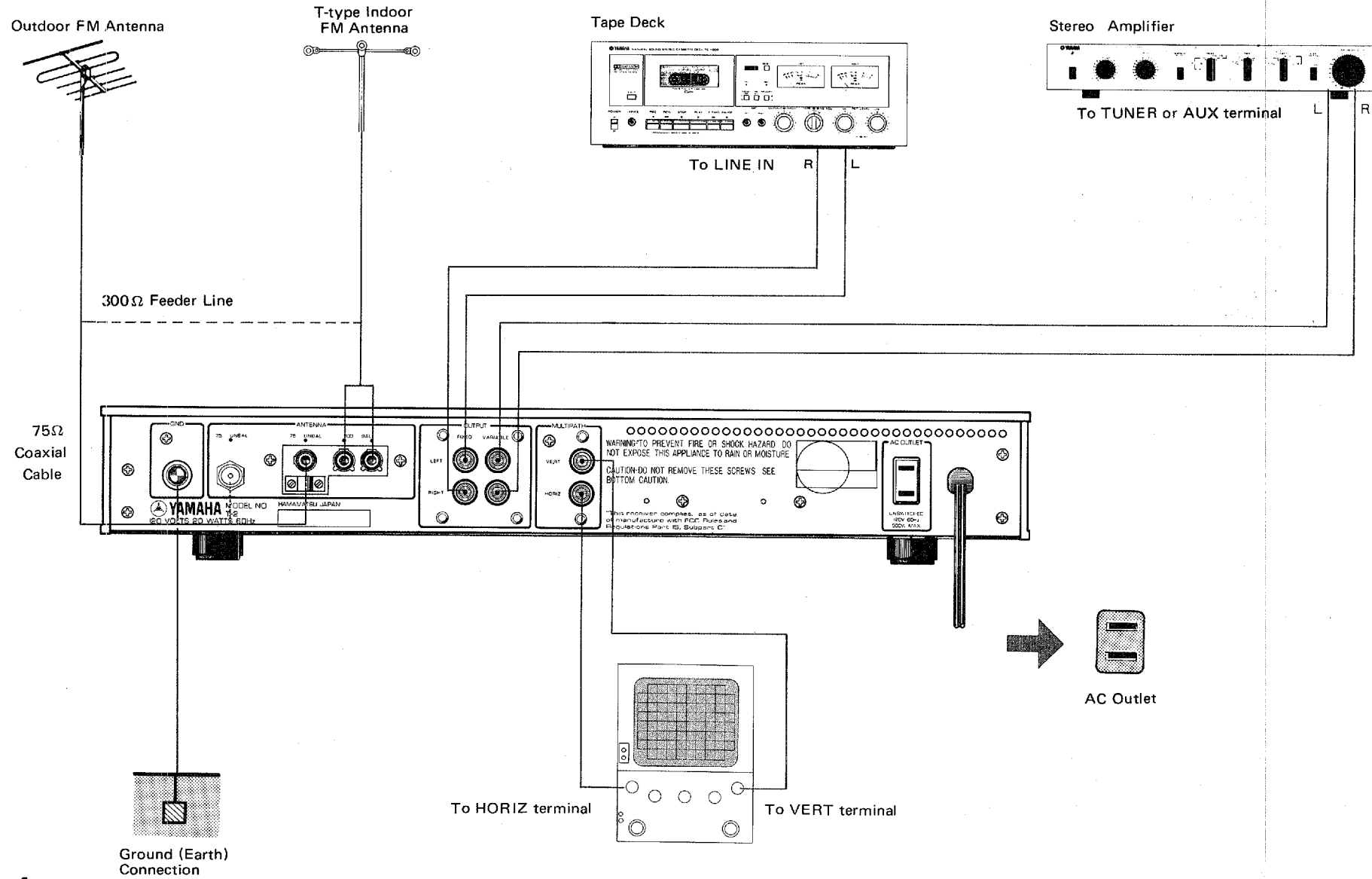

T-2 CONNECTIONS

1 T-TYPE INTERNAL (INDOOR) ANTENNA

The T-type internal (indoor) antenna, which comes with the tuner itself, is for use in areas close to the broadcasting station where there is a strong signal.

First, connect the feeder line of the T-type antenna to the rear panel 300Ω BAL terminals (Fig. 1). Extend the two antenna arms horizontally to form a T, then slowly turn the T until you find the position at which reception is best. Secure the arms in that orientation by attaching to walls or ceiling.

Fig. 1

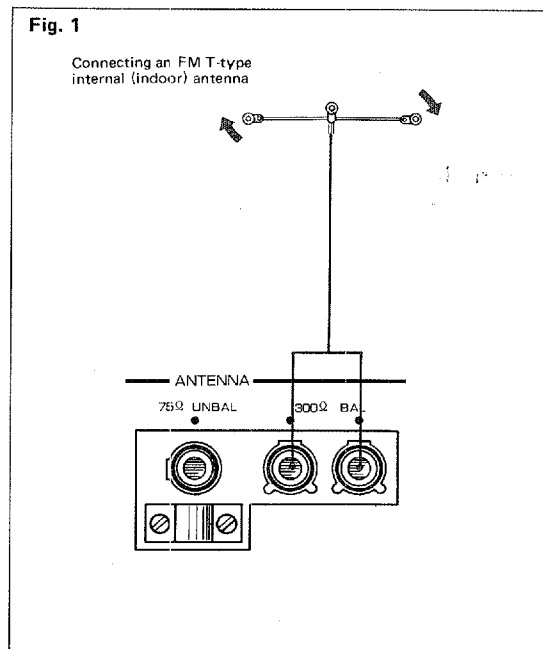

2 FM OUTDOOR ANTENNA

If reception is unsatisfactory with the T-type internal (indoor) antenna, install an outdoor FM antenna (good for both FM reception).

- An FM antenna may be connected to the 300Ω and 75Ω terminals on the rear panel. For an FM antenna, you may use either a 300Ω balanced feeder or a 75Ω coaxial cable. However, in areas in which there is much outside static from motorcycle or auto ignition noise, a 75Ω coaxial cable (3C-2V or 5C-2V) is recommended.

- When connecting up a coaxial cable, be careful not to let the braiding and inner core contact one another so as to cause a short (see Fig. 2).

Fig. 2

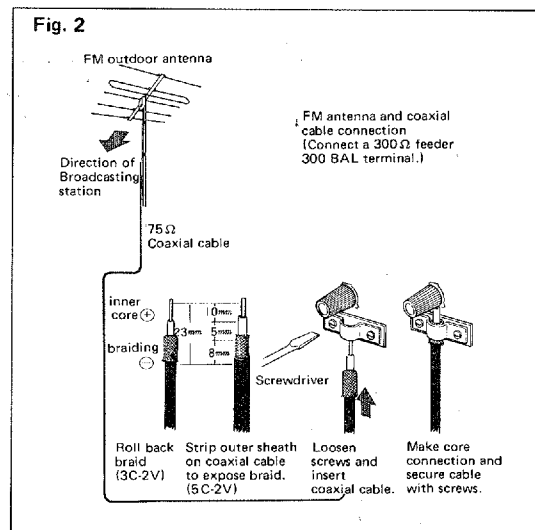

3 F TYPE CONNECTOR

- The F type connector facilitates connection of your T-2 tuner to an outdoor antenna or other through a coaxial cable. To connect the F type connector with a coaxial cable (3C-2V or alike), please follow the procedures shown in the diagram below and do it firmly.

Fig. 3 HOW TO CONNECT F TYPE CONNECTOR

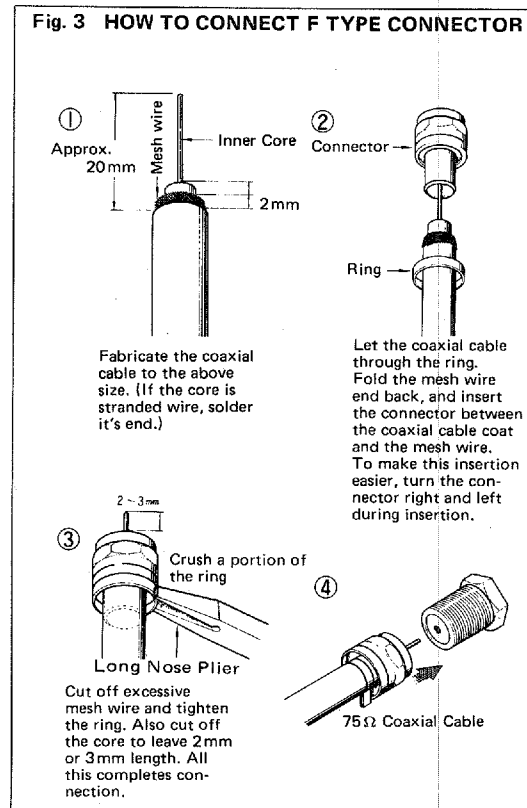

T-2

THE NAMES AND FUNCTIONS OF COMPONENTS

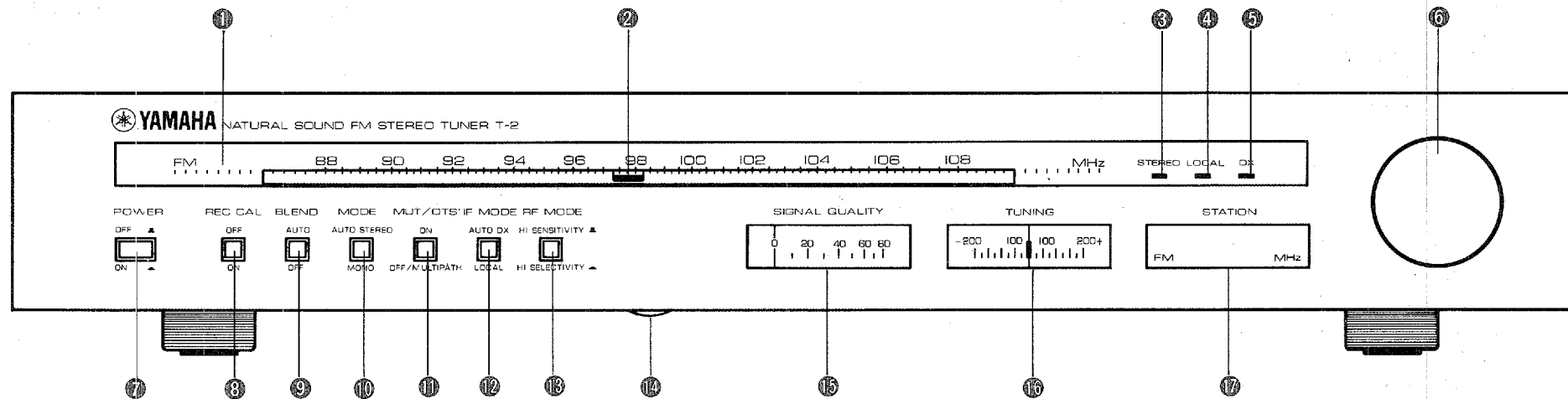

① Tuning Scale

The FM frequency indication is calibrated in MHz (megahertz) units.

② Dial Pointer

Turn the tuning knob so that this pointer points to a station frequency to tune in.

③ STEREO (Stereo Indicator)

This indicator comes on automatically when FM stereo broadcasting is received and goes out automatically when there is monaural reception.

(There is no lighting for monaural reception.)

④ LOCAL (Local Indicator)

It lights up during LOCAL (general) reception. When IF MODE SWITCH is in LOCAL (—), however, it lights up regardless of remote or local reception.

⑤ DX (DX Indicator)

If the DX indicator light is on when the IF MODE switch ② is in the AUTO DX (■) position, it signifies that the tuner is operating in the DX MODE. During FM broadcasts in which there is tuning to a powerful local station, the LOCAL MODE takes over.

⑥ Tuning Knob

Turn this knob to select a station. Watch both the SIGNAL QUALITY METER and TUNING METER to obtain the best possible reception.

⑦ POWER (Power Switch)

When it is depressed, i.e. ON (—) position, power is supplied, and when it is depressed once more, i.e. OFF (■) position, power is turned off.

* Because of the muting circuit, sounds will not be produced instantly when the power switch is turned on. Switch-on of the power can be known by lighting up of lamps illuminating the tuning scale, signal meter, and tuning meter.

⑧ REC CAL (Recording Level Calibration Switch)

When this switch is pressed ON (■) the 333Hz (50% modulation) signal which determines the recording output level is sent from the OUTPUT terminals.
(Refer to p.10 to REC CAL switch.)

⑨ BLEND Switch

In weak reception areas, when a hissing or high-pitched noise makes for poor FM stereo reception, press AUTO (■) this switch. The blend circuit will cut in to eliminate the high-range noise completely. If the BLEND switch is set to the OFF (■), you can obtain better FM stereo separation in the higher ranges whenever there is strong signal. At this time, the stereo indicator becomes dim in proportion to the quantity of blending achieved.

⑩ MODE (Mode Switch)

When this switch is in AUTO STEREO (■), STEREO (Stereo Indicator) lights up and stereo reception is achieved, and when monaural signals are received, it turns out and monaural reception is achieved.
The switch in MONO (■) position forces the tuner monaural reception. This position used for reception of a remote station produces monaural reception even with stereo broadcasting for a better signal-to-noise ratio. Leave the switch in AUTO STEREO (■) position, normally.

⑪ MUT/OTS (Muting/OTS Switch)

With this switch ON (■), you can reduce the background noise that appears when selecting FM stations. However, in poor reception areas, the muting circuit activation may eliminate the weak station itself, so you are encouraged to set to the OFF/MULTIPATH position when tuning in very weak stations.
(In the OFF/MULTIPATH (■) position, FM Multipath detection is possible.
(Refer to p. 10 for multipath detection.)

⑫ IF MODE (IF Mode Switch)

When the switch is AUTO DX (■), DX (long distance) or LOCAL (general) function automatically switches to the other. So, please leave the switch at this position for normal use. The switch turned to LOCAL (■) position compels the tuner to perform the local function regardless of remote or local reception. Use this position if it is your choice.
(Refer to p. 9 for IF MODE SWITCH)

⑬ RF MODE (RF Mode Switch)

The switch turned to HI SENSITIVITY (■) permits high sensitivity receiving. For normal use, use this position.
Use HIGH SELECTIVITY (■) position in order to keep from distortion or crosstalk caused by adjacent station's strong interference.

⑭ OUTPUT LEVEL CONTROL

This knob permits you to adjust the output level of the rear panel OUTPUT VARIABLE terminals from 0.1 to 1Vr.m.s (100% FM modulation).

At the click stop in the center, the output level is 0.5 Vr.m.s.
(r.m.s. = root mean square)

⑮ SIGNAL QUALITY Meter

This meter indicates the quality (static, interference level) of the signal being received. When there is much interference the meter indicator will waver, the amount of deviation reflecting the degree of interference.

* During FM reception, when the MUT/OTS switch is set the OFF/MULTIPATH (■) position, the meter wavering means multipath detection is in process. When the multipath has been detected, adjust in accordance with the multipath detection instructions on p. 10.

⑯ TUNING Meter

This is used when tuning in FM stations: the indicator points to dead center when the tuning knob is turned and the signal quality meter indicator moves to the right.

⑰ STATION (Station Indicator)

When a desired station is tuned in, the indicator displays the station's frequency in digit. (No display is available when a station is detuned.) Generally, use the tuning scale to tune in the desired station's frequency and do micro adjustment by means of SIGNAL QUALITY METER and TUNING METER. Then, use this indicator to verify the frequency of the station you are receiving.

When MUT/OTS SWITCH is in OFF/MULTIPATH (■) position, it keeps light up and keeps displaying the frequency the dial pointer indicates.

T-2

BROADCAST RECEPTION

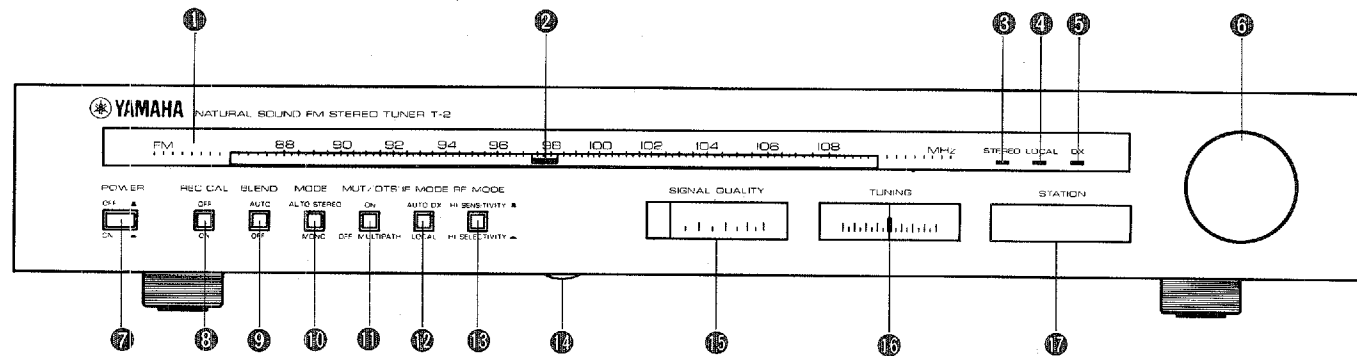

FM RECEPTION

- 1 Check the antenna and amp connections, then switch on the power 7.
- 2 The REC CAL switch 8 is OFF,
 - The BLEND switch 9 is set to AUTO,
 - The MODE switch 10 is set to AUTO STEREO,
 - The MUT/OTS switch 11 is ON,
 - The IF MODE switch 12 is set to AUTO DX,
 - The RF MODE switch 13 is set to the HI SENSITIVITY position.
- * The DX indicator lights up when the tuning is off at this time.
- 3 With the tuning knob 6, turn the tuning indicator 2 approximately to the desired station. The indicator light grows brighter and displays station's frequency in digit as you begin catching the station signal.

*When the signal you receive is sufficiently strong, the LOCAL MODE takes over and the DX indicator light goes out.

- 4 While referring to Fig. 4, tune in FM stations by turning the TUNING knob 6 so that the TUNING meter 16 indicator is placed at the center when the SIGNAL QUALITY meter 15 deflects to the extreme right. The signal quality meter, however, may happen to go further to the right when the TUNING meter is not at the dead center but stays with an amplitude of variation. Such a case, meter display indicates the existence of multipath interference. Change the orientation or position of the antenna so that there will be maximum indication on the signal quality meter when the tuning meter points to dead center (Fig. 4).

Fig. 4
Reading SIGNAL QUALITY meter and TUNING meter

When there is an interference wave, the SIGNAL QUALITY meter indicator deflects as follows.

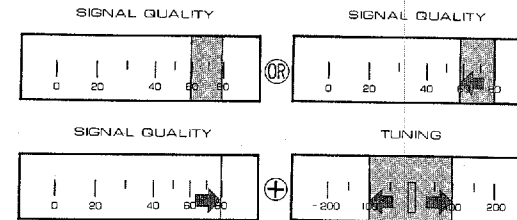

If the SIGNAL QUALITY meter indicator deflects to larger degree when the TUNING meter indicator is displaced from the center position than when it is in the center position, there is an interference wave. Adjust the direction and height of antenna so that the SIGNAL QUALITY meter indicator deflects to the extreme right with the TUNING meter indicator placed in the center.

When there is not interference wave:

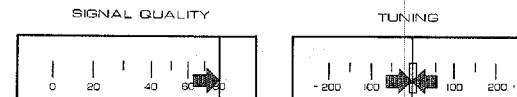

T-2

IF MODE SWITCH











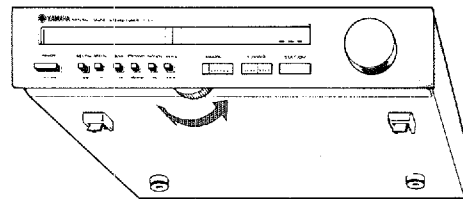

- 5 The STEREO indicator  lights up when the station is broadcasting stereo. It goes out automatically in the case of monaural. Adjust the output of the OUTPUT VARIABLE terminal by means of the OUTPUT LEVEL control . (Fig. 5)
- Note: For fine adjustments applicable to specific receiving conditions, please refer to 1, 2, and 3.



Fig. 5



By pulling the nail of this leg, the front panel can be turned upward. Do so when necessary.

- 1 For reception in the area of weak field strength remote from a station, where high sensitivity and remote receiving function are required, it is recommended to use RF MODE SWITCH  in HI SENSITIVITY () and IF MODE SWITCH  in AUTO DX (). In order to further secure the tuner's receiving capacity, use MODE SWITCH  in MONO () position, and MUT/OTS SWITCH  in OFF/MULTI-PATH () position, respectively. This remote reception however presents sound quality inferior to local reception.



- 2 If and when remote reception is subject to strong interference by an adjacent station (interference by an adjacent station or intermodulation interference by a powerful station), bring RF MODE SWITCH  to HI SELECTIVITY () position, whereby the dynamic range of the FR (front end) section is extended and at the same time a further increase is achieved in selectability so as to reduce interference by strong waves. With a station which imposes no interference, the switch in this position exhibits about one half sensitivity of that available in HI SENSITIVITY position. Please therefore use HI SENSITIVITY position when receiving a station free from interference by strong waves.

- 3 STATION indicator  lights up and displays a tuned frequency when it goes in tune with a station powerful to some extent as far as MUT/OTS SWITCH  is ON () position (that is, as far as muting circuit does not function). Here, notice that this indicator is not able to achieve fine adjustment, so do it with TUNING meter.

IF MODE SWITCH

This T-2 switch (Fig. 6) enables you to obtain good reception in remote areas or there is much interference.

●AUTO DX () Position

In a poor FM reception area or when there is interference from a nearby station, setting to the AUTO DX () position will automatically activate the DX MODE and its indicator light will come on. In the AUTO DX () position you get maximum suppression of interference as well as excellent sensitivity when listening to weak signals.

When the station signal is sufficiently strong, the T-2 automatically switches to LOCAL MODE for a wider range of reception with minimal distortion and excellent sound quality.

●LOCAL () Position

Set to this position whenever there is sufficiently large antenna input and only slight interference with reception. The low distortion characteristic takes over and you obtain crystal clear sound of very high resolution.

* In remote areas with poor reception, you are encouraged to set to the AUTO DX () position.

Fig. 6



T-2

REC CAL SWITCH AND MULTIPATH DETECTION

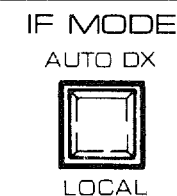
REC CAL

A suitable sound level is essential if you hope to obtain good sound quality when recording FM broadcasts. Press on the REC CAL switch for an OUTPUT terminal signal of 333Hz (50% modulation). When the tape deck is connected up, you can thus obtain a suitable recording level at all times irrespective of the program (Fig. 7). When setting for the right recording level, adjust either the T-2 OUTPUT LEVEL control or the deck LINE INPUT level control to the values indicated in the table below.

Tape Used	Setting Level By REC CAL
CrO ₂ tape	-6VU
LH tape	-4VU
FeCr type	-2VU

* The above values are only a rule of thumb. The actual value may differ in terms of the tape deck or FM modulation.

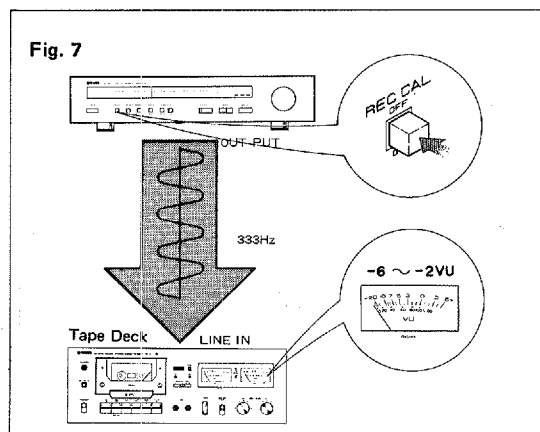

* If you switch off the power in the REC CAL (OFF) position, a certain amount of signal sound remains.

MULTIPATH DETECTION

FM multipath is somewhat like the TV "ghost" phenomenon. As shown in Fig. 8, some FM signals are received directly by the antenna while others reach it from many directions, bouncing off buildings or mountains. The latter are called multipath waves. These are received only slightly later than the direct waves, and this causes some sound distortion, separation and deterioration in tonal quality. This multipath effect can be prevented by using a tall antenna with good directional characteristics and by installing it after careful study to obtain the right orientation so as to eliminate interference.

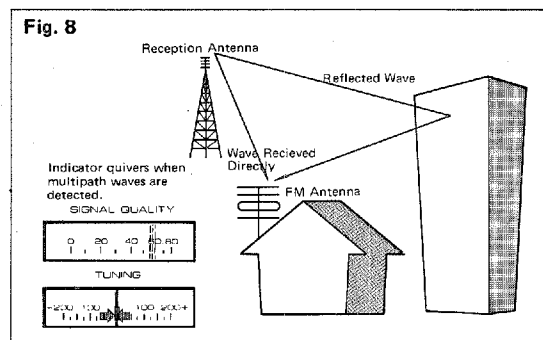

Multipath Detection

During FM reception, a delicate quiver of the signal meter indicator when the MUT/OTS switch is set to OFF/MULTIPATH (OFF) indicates multipath interference. Change your antenna orientation or position so that the indicator stabilizes.

•Using Oscilloscope

Connect VERT and HORIZ terminal i.e. MULTIPATH terminals, provided on the T-2' rear panel, to VERT (vertical) and HORIZ (horizontal) input terminals on a oscilloscope, and make the T-2 tune in with a station correctly and bring the Braun tube to display wave form.

Please refer to the below photographs to adjust the position and height of an antenna if multipath is revealed on the Braun tube.

Wave forms on oscilloscope

Photo. 1
No multipath exists

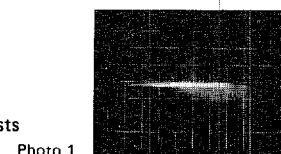
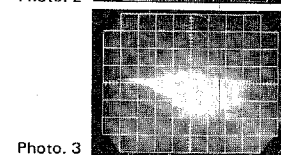
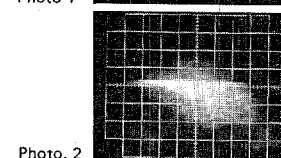

Photo. 2 & 3
Multipath exists



T-2

CIRCUIT EXPLANATION

1. FRONT END

Three dual-gate MOS FETs are used in the front end, allowing easy transmission of high-frequency signal to the rear stage. Further, an RF MODE switching circuit is provided for the first time in the world, enabling selection of a sensitivity in accordance with wave conditions of a station. The switch provides HI SENSITIVITY and HI SELECTIVITY positions. In the HI SENSITIVITY

position you can receive a station placing emphasis on the sensitivity, while in the HI SELECTIVITY position you can reject interference from a near station to securely obtain a desired wave. All this insures higher quality reception by matching the nature of radio waves you are receiving. (The circuit operation is shown in the block diagram below.)

2. DIGITAL READOUT

The T-2 provides a STATION indicator which digitally indicates the frequency when a station is tuned in. The indicator has an OTS (optimum tuning system), which is OFF during tuning but turns ON to automatically lock the frequency to the correct tuning point once a station is tuned in.

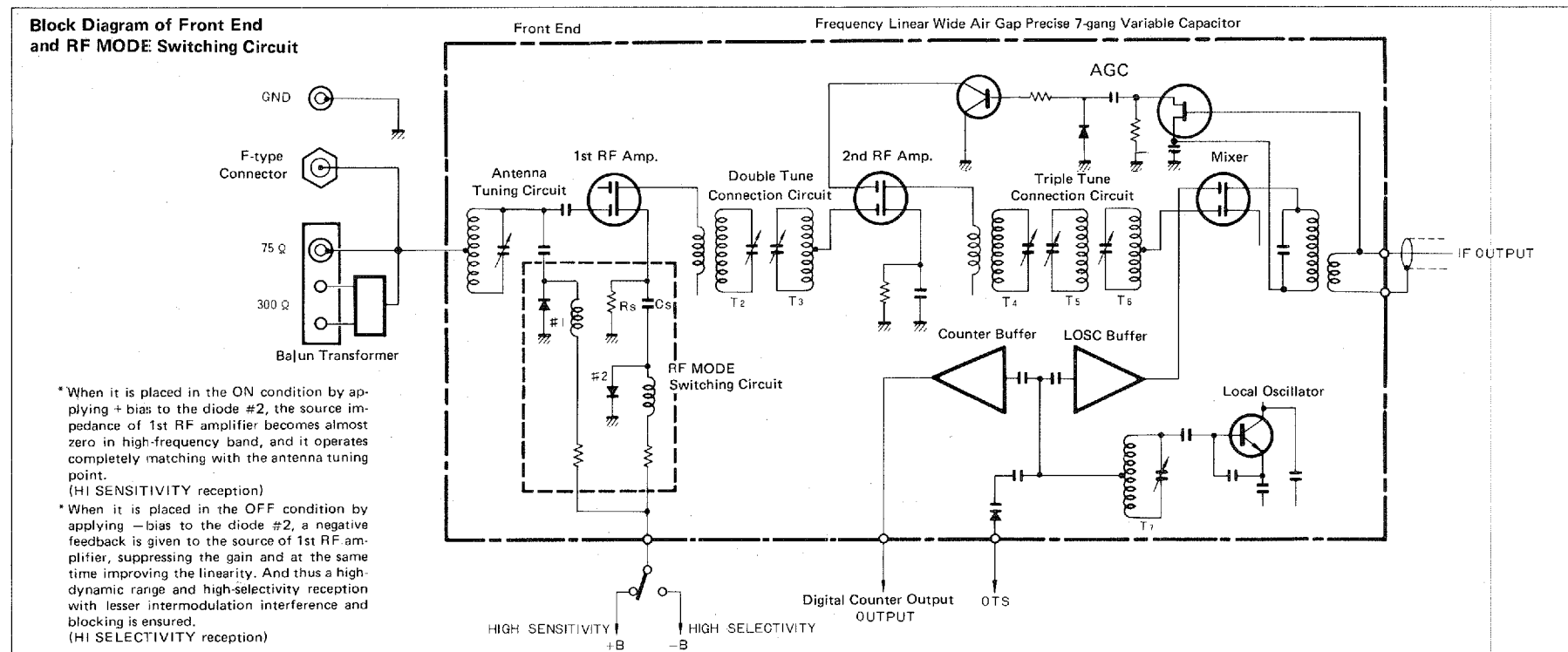

3. IF (Intermediate Frequency Amplifier) STAGE

To ensure high-quality reception under every wave condition, the T-2 provides an AUTO DX circuit which automatically switches IF band by checking the quality of receiving wave. For the LOCAL position which permits superior audio quality in a reception with comparatively less interference, are used two ceramic block filters checked and adjusted through differential-gain direct-assessment, and IF amplifier with a 7-stage differential current limiter and buffer amplifier is applied. These IF block filters with superior transmission characteristics realize high audio qualities of 55dB stereo separation and 0.05% distortion factor (stereo

1kHz) while ensuring a sufficient selectivity of 55dB in a normal area. Further, for the DX position which effects good reception in areas with much interferences, is used a low-spurious ceramic block filter of which the transmission characteristic is also checked through a differential-gain direct-assessment and which is equivalent to eight elements, making the effective selectivity 100dB. This AUTO DX circuit detects interference through the interference-detector circuit and switches IF band by operating the transistor switch. For the discriminator, is used a wide-band balanced ratio detector which is also analyzed through the differential gain direct-assessment, ensuring a detector output with a very low distortion.

Direct Assessment of Differential Gain

To improve interference-rejection characteristics for FM reception a high selectivity is to be obtained. But there is a problem that improving a selectivity results in an increased distortion and lowered fidelity. To ensure a lowest possible distortion and higher separation while improving a selectivity, Yamaha introduced a direct assessment of differential gain. This method checks a deviation of amplitude-conversion gain to a faint frequency shift in an FM signal transmission system, and permits a superior audio quality by reducing the differential-gain deviation while securing a required selectivity.

Block Diagram of AUTO DX Circuit

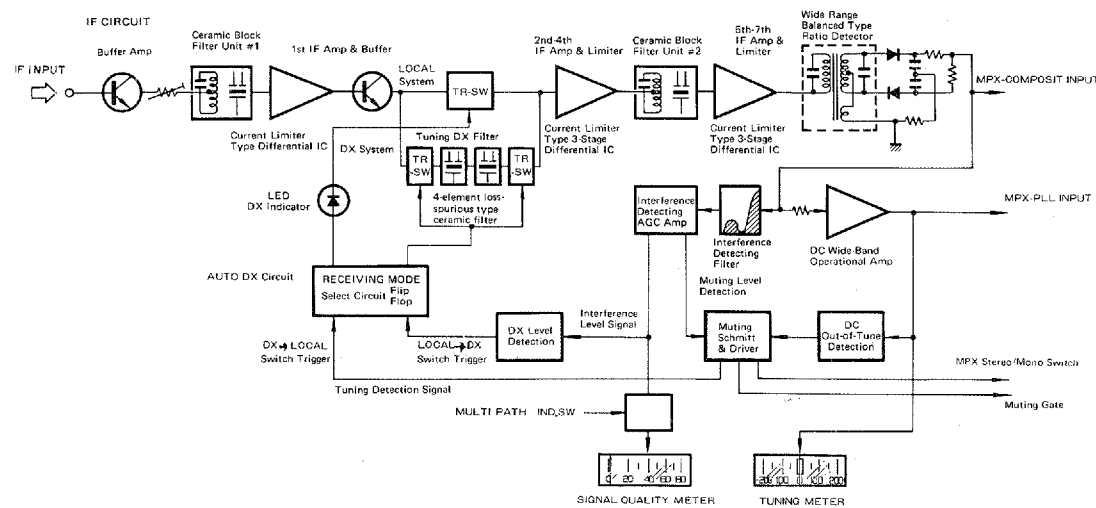

AUTO DX OPERATION

- At time of station selection . . . Normally in DX MODE (High sensitivity, selectivity)
- After station selection
 - When there is no interference and sufficient antenna input . . . Switches automatically to LOCAL MODE (Low distortion reception)
 - When there is much interference or insufficient antenna input . . . Switches to DX MODE for high interference suppression characteristics. (High sensitivity, selectivity)
- When Intermittences . . . Keep to DX MODE.

4. DC-NFB-PLL-MPX CIRCUIT

As the MPX circuit demodulates a stereo composite signal through switching it by 38 kHz sub-carrier, the intermodulation distortion in the circuit needs to be extremely reduced. This is because the composite signal thus switched contains frequency response of DC to over 1MHz. The MPX circuit of the T-2 makes up a unique DC-NFB-SWITCHING circuit on the foundation of a high slew rate DC amplifier. The PLL section for subcarrier generation provides an interference filter, forming an anti-interference PLL system which is hardly affected by a stereo signal. Further, utilizing 19kHz signal generated in the PLL section, 19kHz signal with the level and phase equivalent to those of the input pilot signal is reproduced,

and, passing through the waveform converter circuit, it becomes almost completely equivalent to the pilot signal in the waveform, level and phase to cancel the pilot signal in the input section of switching circuit. This tracking-type pilot pure cancel circuit permits demodulation of only pure composite signal without 19kHz pilot signal which is unnecessary for the multiplex stereo decoder. All this result in the MPX demodulation system with extremely low intermodulation distortion, and at the same time enable the cutoff frequency of low-pass filter at the rear stage to be set to over 19kHz for a stable reproduction frequency response — almost flat at up to 18kHz.

5. METER & MUTING SYSTEM

The signal meter indicates a signal quality based on interference detection (indicates S/N ratio in the stereo mode). It permits quick setting of time constant with the MUT/OTS switch placed in the OFF/MULTIPATH position, and eases interference detection in multipath phasing, etc. With the muting system a de-tuning detector signal and an interference detector signal are applied to the Schmitt circuit, forming a powerful detector system against erroneous operation. And the driven gate section is provided in two stages after and active-load emitter-follower buffer amplifier (2-stage symmetrical gate muting circuit). Also, a timing circuit is put against power ON-OFF to effect muting.

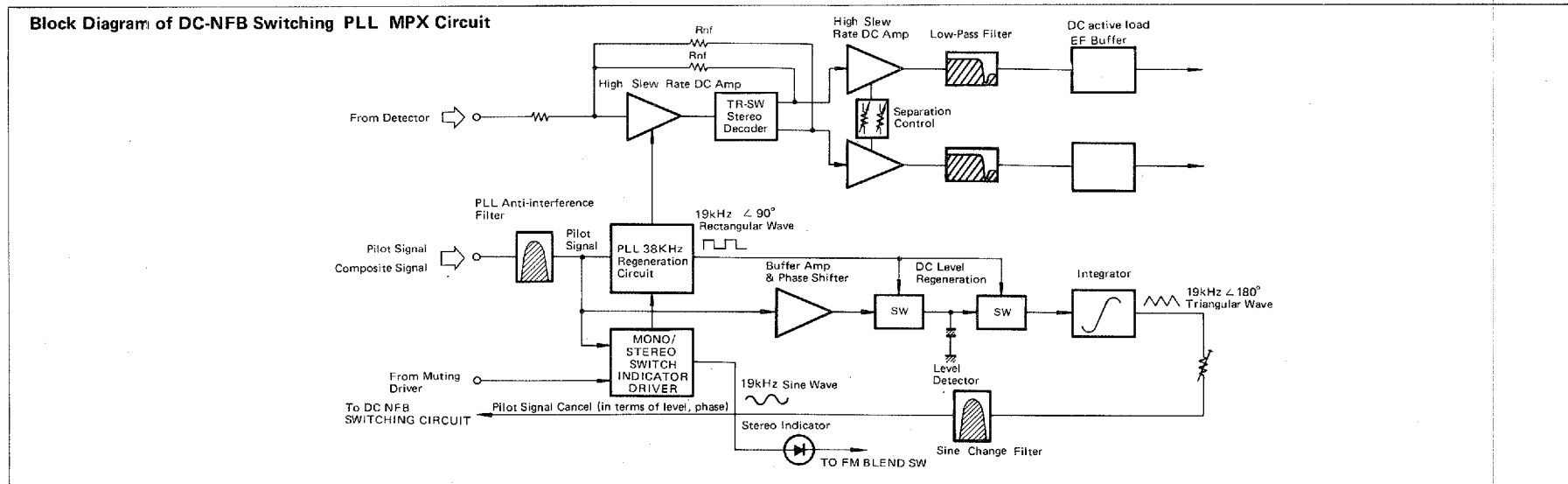

■ Output/Noise Level vs. Antenna Input Level

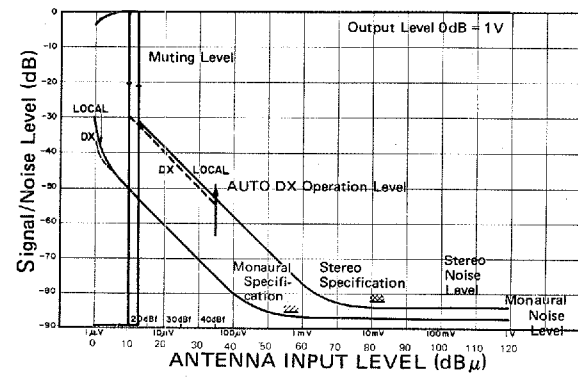

■ Antenna Input Level vs. Distortion

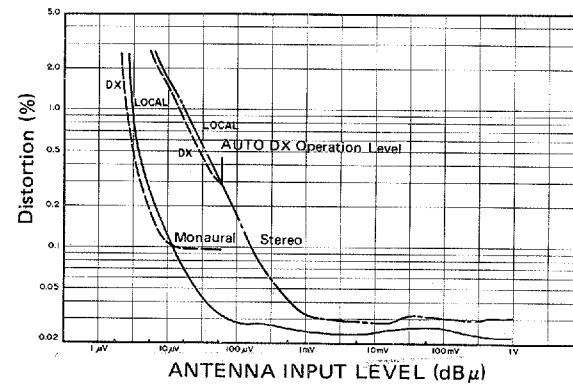

■ Distortion, Mistuning and OTS Effect

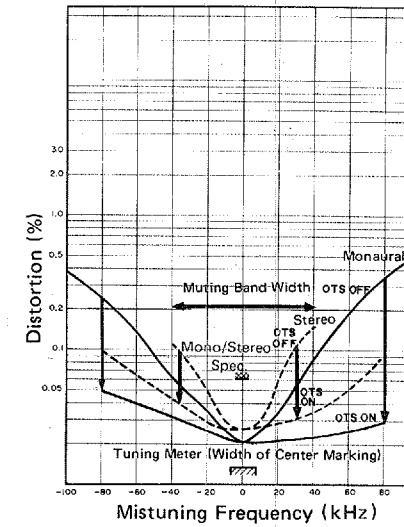

■ Modulation Frequency vs. Distortion

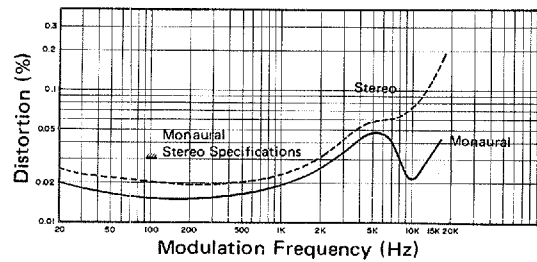

■ Frequency Characteristic and Separation Characteristic

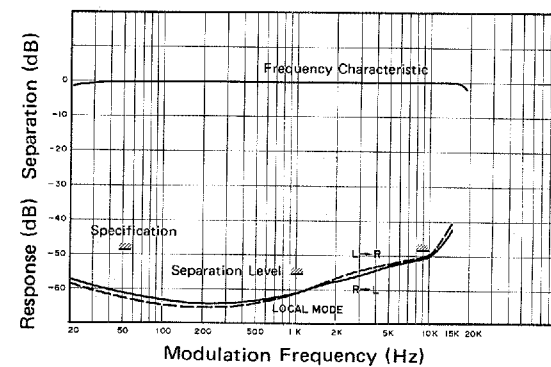

■ Effective Selectivity Characteristic

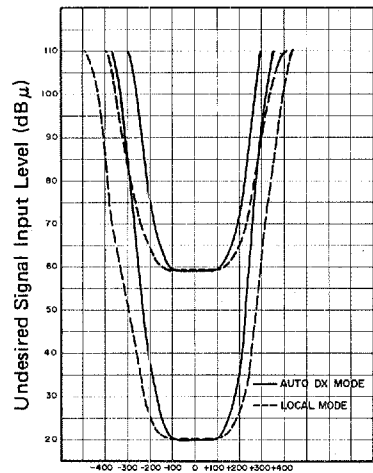

Undesired Carrier Frequency's Deviation From Desired Carrier Frequency (kHz)

■ Capture Ratio

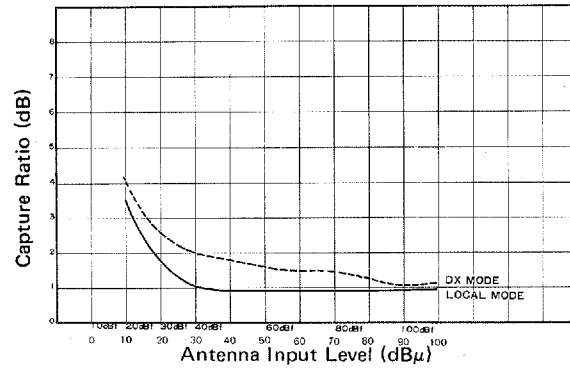

■ RF Intermodulation Characteristics

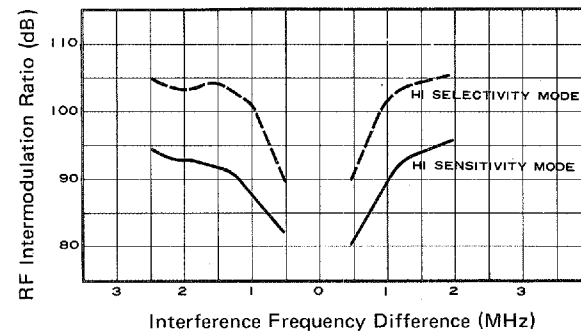

■ Comparison of MPX Circuit Characteristics

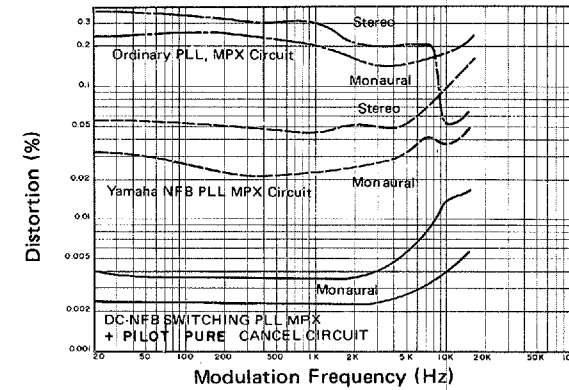

■ Signal Quality Meter Indication Characteristic

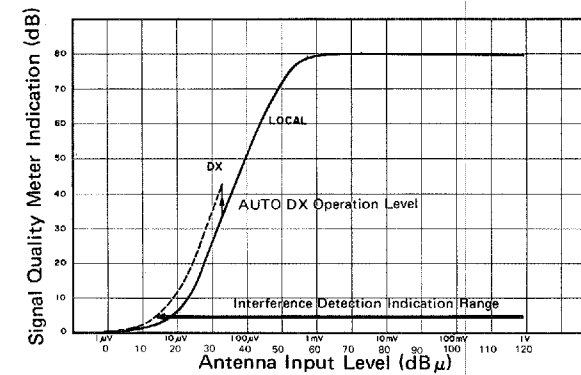

T-2

SPECIFICATIONS

FM SECTION

Tuning Range	87.6 to 108 MHz
50 dB Quieting Sensitivity	
Mono (HI SENS., AUTO DX MODE)	2.5 μ V 13.2 dBf
Stereo (HI SENS., AUTO DX MODE)	28 μ V 34.2 dBf
Usable Sensitivity (40 kHz Dev.)	
IHF (98 MHz)	
HI SENS. MODE	1.5 μ V (300 Ω) 8.8 dBf
HI SELECT MODE	3 μ V (300 Ω) 14.8 dBf
Image Response Ratio (98 MHz)	120 dB
IF Response Ratio (98 MHz)	120 dB
Spurious Response Ratio (98 MHz)	120 dB
AM Suppression Ratio (IHF)	68 dB
Capture Ratio (IHF)	
LOCAL MODE	1.0 dB
DX MODE	1.5 dB
Alternate Channel Selectivity (IHF)	
AUTO DX, HI SELECT MODE	100 dB (Automatically switched to DX mode by interference detection)
LOCAL MODE	55 dB
Signal-to-Noise Ratio (at 65 dBf)	
Mono	88 dB
Stereo	85 dB
RF Intermodulation (± 1 MHz)	
HI SELECT MODE	100 dB
HI SENS. MODE	85 dB

Distortion (at 65 dB)

Mono	LOCAL MODE	DX MODE
100Hz	0.03%	0.1%
1kHz	0.05%	0.15%
6kHz	0.08%	0.3%
10kHz	0.05%	0.1%
Stereo	LOCAL MODE	DX MODE
100Hz	0.05%	0.4%
1kHz	0.05%	0.4%
5kHz	0.07%	0.6%
10kHz	0.1%	1.0%
IM Distortion (IHF)	LOCAL MODE	DX MODE
Mono	0.03%	0.3%
Stereo	0.08%	0.5%
Stereo Separation	LOCAL MODE	DX MODE
1kHz	55dB	35dB
50Hz to 10kHz	48dB	30dB
Frequency Response		
30 Hz to 15 kHz	+0.3 dB, -0.5 dB	
10 Hz to 18 kHz	+0.3 dB, -3 dB	
Subcarrier Product Ratio	72 dB	
Muting Threshold	3 μ V (14.8 dBf): AUTO	
	DX HI SENS. MODE	
AUTO DX Active Level	50 μ V (39.2dBf)	
	(Automatically switched to DX mode when interference level reaches approx. -50 dB in stereo mode.)	
AUDIO SECTION		
Output Level/Impedance		
- Variable Terminals -		
FM (100% mod. 1 kHz)	0.1 to 1V/2.5 k Ω	
	(VR min. to max.)	
	500 mV/2.5 k Ω	
	(VR center)	
REC CAL Signal	50 to 500 mV/2.5 k Ω	
	(VR min. to max.)	

250 mV/2.5 k Ω

(VR center)

(333 Hz; Corresponding to 50% FM modulation)

- Fixed Terminals -

FM (100% mod. 1 kHz) 1V/330 Ω

REC CAL Signal (333 Hz) 500 mV/330 Ω

General

Semiconductors	60 Transistors, 19 ICs
	11 FETs, 32 Diodes, 5
	Zener Diodes, 3 LEDs,
	4 Ceramic Block Filters,
	1 Quartz Oscillator
Power Supply	120V AC, 60 Hz
Power Consumption	20W
Dimensions (W x H x D)	435 x 70 x 349 mm
	(17-1/8x2-3/4x13-3/4")
Weight	7 kg (15 lb / oz)

1. Measuring Instruments

This tuner was adjusted and measured by the following measuring instruments which include standard type and our specially-specified ones.

VHF FM SG: MSG-297 or 296 (Meguro Denpa Sokki)

VHF FM SG: GE501 A (Ando)

Stereo Modulator: MSG-211FSII

(Meguro Denpa Sokki)

Matching Transformer (50 to 300 Ω : ST Model 100

(Sound Technology)

Distortion Analyzer: YHP-4333A

(Yokogawa-Hewlett-Packard)

2. Adjustment and Measurement Conditions

Adjustment and measurement were made in accordance with the surrounding and measurement conditions provided by our company. (Conform to IHFM T-200.)

Specification subject to change without notice.

T-2

BLOCK DIAGRAM

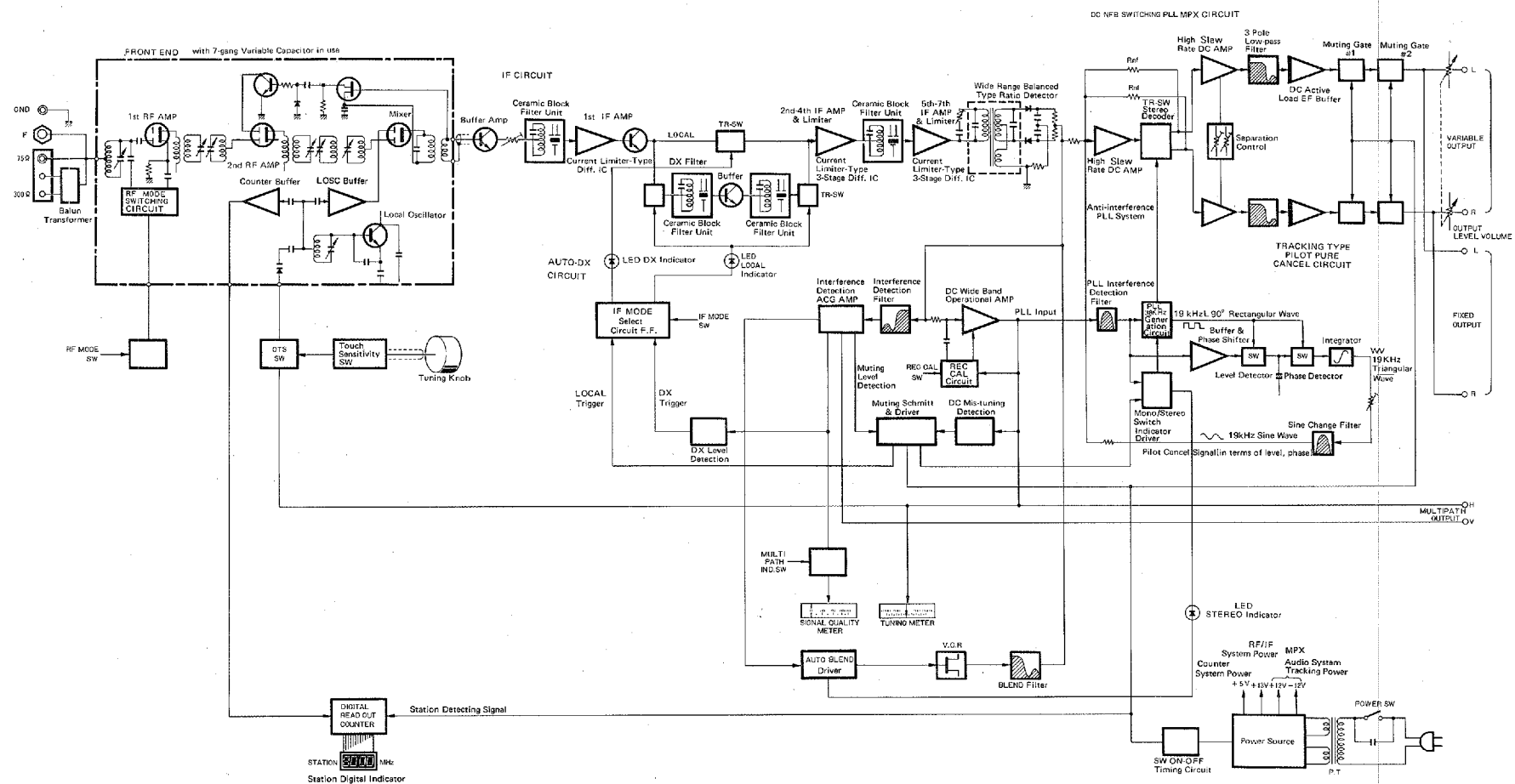

T-2

SCHEMATIC DIAGRAM

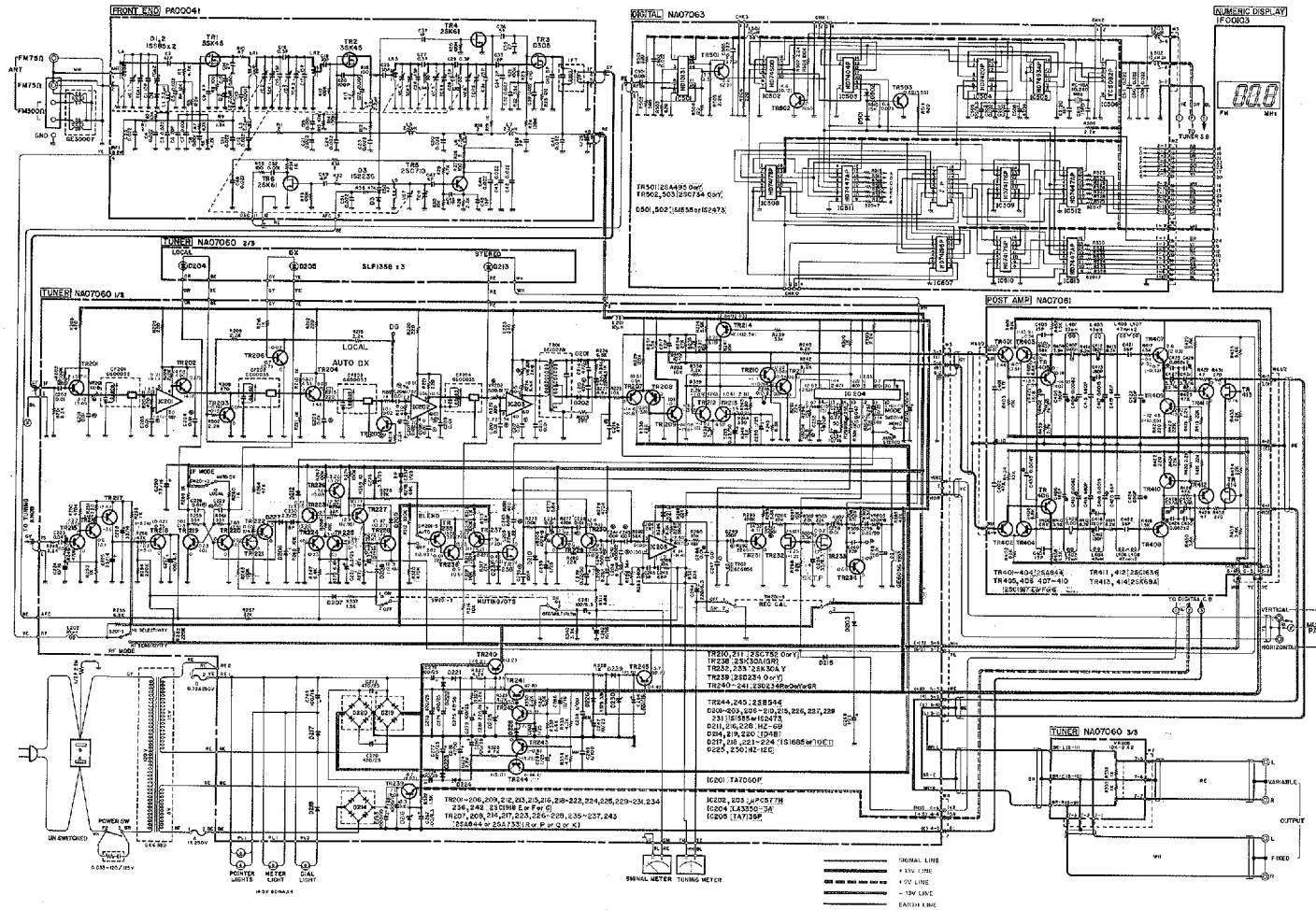

DESTINATION	TIME CONSTANT	Capacitor					Resistor
		C405, 406	C409, 410	C415, 416	C417, 418	C423, 424	
U.S. & Canada, General	75µS	0.0015µF	0.01µF	470pF	0.0033µF	0.001µF	8.8kΩ
Europe, North Europe, British, Australia	50µS	180pF	0.0082µF	680pF	0.0015µF	680pF	8.2kΩ

T-2

TROUBLE SHOOTING

Before assuming that your T-2 is malfunctioning, check the following trouble shooting list. There may be corrective action you can undertake by yourself without having to call a service representative.

	Fault	Cause	Cure
FM Broadcast Reception	Occasional crackling interference, especially in poor reception areas.	Ignition noise from passing cars, motorcycles.	Install a tall FM antenna as far from the road as possible. Use a coaxial feeder.
		Interference from thermostat-equipped electricals.	Equip the offending device with a noise suppressor.
	Stereo reception ruined by annoying static.	FM stereo broadcasts are prone to this in remote areas with weak antenna input.	Install an outdoor FM antenna, or increase the number of elements in the one you already have. Switch on BLEND or change from MUT/OTS to OFF/MULTIPATH.
	The STEREO indicator flickers and there is much static during stereo reception.	Insufficient antenna input, imperfect tuning.	Install an antenna to match your local signal strength.
	Sound is distorted or reception not clear despite use of an outdoor FM antenna.	Signal input from the antenna is too strong.	Try changing back to the indoor T-type antenna (standard equipped).
	During stereo test transmissions, sound which should come from only one channel is heard faintly from the other.	This is the crosstalk phenomenon. A certain degree is normal.	This does not constitute a fault as long as the leakage of one channel into the other is very small compared to the normal level for that channel.

Service should be requested at the point of purchase or at the audio department of your nearest Yamaha dealer.

SINCE 1887  **YAMAHA**
NIPPON GAKKI CO., LTD. HAMAMATSU, JAPAN