

**Nikon**

**N65 N65 QD**

N65 N65 QD

**INSTRUCTION MANUAL**

**E**

# Introduction

- Thank you for purchasing the Nikon N65/N65QD—a camera that is sure to make photography a bigger part of your life. Get to know your N65/N65QD camera, and be sure to read this manual thoroughly before using it. We recommend that you keep this manual handy.

## Main features of the N65/N65QD:

- **Exposure mode dial** makes operation simple and intuitive, so great pictures are a snap in every shooting situation.
- The big, high-visibility **LCD** lets you check camera settings at a glance.
- With  **AUTO** and **Vari-Program** modes, you don't have to be a pro to take better pictures—just press the shutter release button.
- **3D Matrix Metering** can read atmosphere as well as brightness and contrast, for recording the scene in all its nuanced detail.
- Wide-coverage **Five-Area Dynamic AF system** keeps subjects in clear focus and eliminates unintended blurring.
- The **auto pop-up** Speedlight, featuring **Matrix Balanced Fill-Flash**, throws just the right light on a scene to make the shot look beautiful and natural.
- Crisp, precise film advance and shutter release assure superb **2.5-frame-per-second continuous shooting**.
- The Nikon N65/N65QD is so **compact** and **lightweight**, anyone can handle it.

## ■ Take trial shots

Take trial shots before shooting at important occasions like weddings or graduations.

## ■ Have Nikon spot-check your camera regularly

Nikon recommends that you have your camera serviced by an authorized dealer or service center at least once every two years.

## ■ Using your camera correctly

The Nikon N65/N65QD's performance has been optimized for use with Nikon brand accessories. Accessories made by other manufacturers may not meet Nikon's criteria for specifications, and nonconforming accessories could damage the N65/N65QD's components. Nikon cannot guarantee the N65/N65QD's performance when it is used with other than Nikon brand accessories.

## Supplied accessories



Body cap (P. 19)

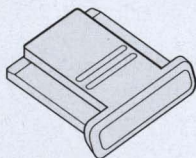

Accessory shoe cover

*\* Remove this cover when attaching an optional Speedlight to the accessory shoe.*

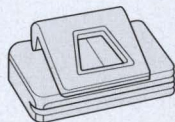

Eyepiece cap DK-5 (P. 67)

# Contents

Introduction .....	2-3
Nomenclature .....	6-7
LCD Panel/Viewfinder Display.....	8-9
Available Exposure Modes.....	10-11
<b>Start Shooting Immediately</b> .....	12-13

## **PREPARATION ..... 15-24**

1. Install Batteries and Check Battery Power .....	16-17
2. Mount Lens.....	18-19
3. Load Film.....	20-21
4. Set Date and Time (N65QD only) .....	22-23
About Shutter Release Button.....	24

## **BASIC OPERATION ..... 25-41**

1. Set Focus Mode to AF .....	26-27
2. Set Exposure Mode to  .....	28-29
3. Hold Camera and Focus .....	30-31
4. Release Shutter .....	32-33
Using Built-In Speedlight .....	34-35
Shooting with Vari-Program .....	36-38
Imprinting Date/Time (N65QD only).....	39
Self-Timer Operation .....	40-41

About Metering Systems and Exposure.....	42
--	----

**DETAILED OPERATION .....43-73**

Focus Mode .....	44-45
Focus Area .....	46-47
AF-Assist Illuminator .....	48-49
Focus Lock .....	50
Shooting in Each Exposure Mode.....	51-60
AUTO mode .....	51
Auto-Multi Program/Flexible Program.....	52-53
Shutter-Priority Auto .....	54-55
Aperture-Priority Auto.....	56-57
Manual .....	58-60
Exposure Compensation .....	61
Auto Exposure Bracketing .....	62-63
Multiple Exposure.....	64-65
Film Rewind .....	66
Diopter Adjustment/Viewfinder Accessories .....	67
Depth-of-Field Preview .....	68
Remote Control Operation (optional) .....	69-72
Available Mode Combinations.....	73

About Depth of Field .....	74
----------------------------	----

**FLASH PHOTOGRAPHY ..... 75-86**

Built-In Speedlight and TTL Flash Modes .....	76
Ready-Light/Accessory Shoe .....	77
Flash Sync Mode Features .....	78-79
Using Built-In Speedlight .....	80-83
Flash Shooting Distance Range .....	84
Usable Lenses with Built-In Speedlight.....	85
Available Flash Sync Mode Combinations .....	86

**MISCELLANEOUS .....87-113**

Lens Compatibility.....	88-90
Usable Optional Speedlights.....	91-93
Optional Accessories .....	94-95
Camera Care .....	96-97
Notes on Batteries .....	98
Troubleshooting.....	99-101
Glossary.....	102-105
Specifications .....	106-110
Index.....	112-113

# Nomenclature

Focus mode selector (PP. 44-45)

Lens release button  
(P. 19)

Flash lock-release (P. 80)/  
Flash sync mode button  
(P. 78)

Focus area (P. 46)/  
AF-Assist Illuminator  
cancel button (P. 49)

Camera strap  
eyelet

Exposure mode dial  
(P. 10)

Self-timer/Remote control  
button (P. 40/69)

Auto Exposure Bracketing (P. 62)/  
Multiple Exposure (P. 64)/  
Film rewind button (P. 66)

Accessory shoe (P. 77)

Depth-of-field preview button (P. 68)

Remote control sensor  
(P. 69)

Power switch (P. 16)

Shutter release  
button (P. 17/24)

Camera strap  
eyelet

Aperture (P. 59)/  
Exposure  
Compensation button  
(P. 61)/Film rewind  
button (P. 66)

LCD panel (P. 8)

Self-timer (P. 40)/  
AF-Assist Illuminator (P. 48)/  
Red-Eye Reduction lamp  
(P. 79)

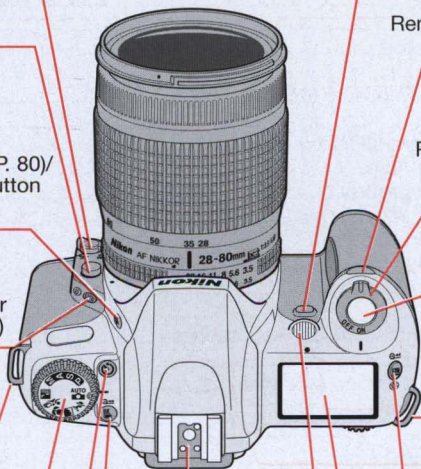

Viewfinder eyepiece

Diopter adjustment lever (P. 67)

Rubber eyecup (P. 67)

Command Dial

Camera back lock release lever (P. 20)

Film confirmation window (P. 21)

Data Back (N65QD only)  
(P. 22/39)

Tripod socket

Battery chamber cover lock lever  
(P. 16)

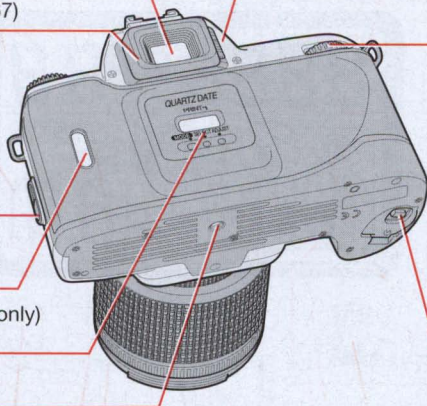

\* Illustration shown is the N65QD. The camera back of the N65 differs from the N65QD.

## ■ N65QD only: Data imprint LCD/buttons

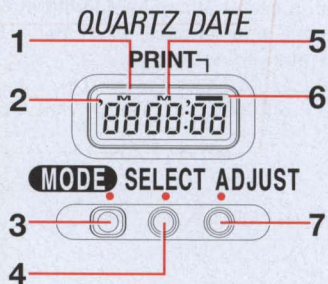

1. Date/time display LCD
2. ': Year indicator
3. MODE button: Push to select one of five available displays.
4. SELECT button: Push to select date/time to be adjusted.
5. **M**: Month indicator
6. **—**: Data imprint indicator: Blinks approx. 2 sec. when data is imprinted.
7. ADJUST button: Push to adjust date/time.

# LCD Panel/Viewfinder Display

## ■ LCD panel

Remote control (P. 69)

Self-timer (P. 40)

Shutter speed

Aperture

Exposure Compensation (P. 61)

Multiple Exposure (P. 64)

Battery power (P. 17)

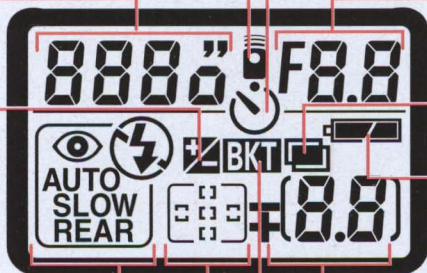

Flash sync mode (P. 78/80)

Frame counter (P. 21)/  
Exposure Compensation  
value (P. 61)

Focus area (P. 46)

Auto Exposure Bracketing (P. 62)

\* The illustrations are fully labeled for your reference.

## **NOTE: About LCD**

The LCD panel and viewfinder displays tend to turn darker at high temperatures and have slower response time at low temperatures. In either case, when the temperature returns to normal, the displays also return to normal.



## ■ Viewfinder display

Focus area (focus brackets) (P. 30/46)

12mm-dia. reference circle for Center-Weighted Metering area (P. 58)

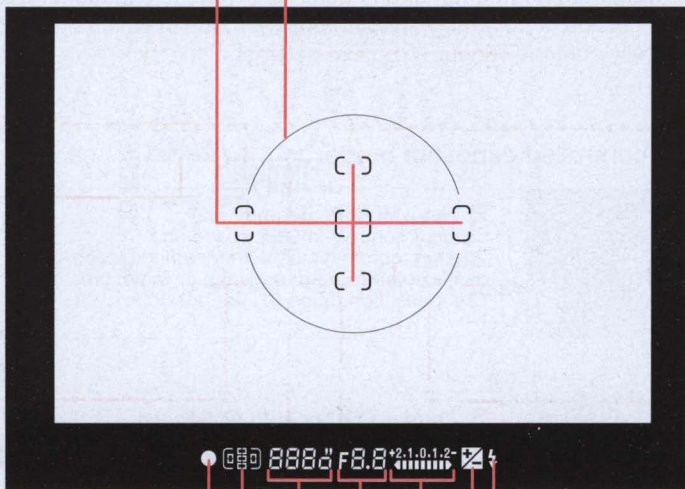

Focus indicator (P. 31)

Flash ready-light (P. 77)/  
Flash recommended  
indication (P. 76/80)

Focus area (P. 46)

Exposure Compensation  
(P. 61)

Shutter speed

Electronic analog exposure  
(P. 59)/Exposure Compensation  
value display (P. 61)

Aperture

# Available Exposure Modes

The exposure mode dial of the Nikon N65/N65QD can be divided into two sections. One is the user-controlled exposure mode with Auto-Multi Program, Shutter-Priority Auto, Aperture-Priority Auto or Manual exposure modes, where the photographer can determine various exposure factors. The other section is point-and-shoot exposure mode in which the camera automatically controls various exposure settings.

## ■ User-controlled exposure mode



### **P: Auto-Multi Program (P. 52)**

Camera controls shutter speed and aperture automatically. Other settings, such as Flexible Program (page 53) or Exposure Compensation (page 61) are possible.



### **S: Shutter-Priority Auto (P. 54)**

You set desired shutter speed, and the camera selects the correct aperture. Freeze the motion of a moving subject or blur the subject.



### **A: Aperture-Priority Auto (P. 56)**

You set the desired aperture, and the camera selects the correct shutter speed. Lets you determine depth of the in-focus area.



### **M: Manual (P. 58)**

Shutter speed and aperture are set manually. Suitable for taking photographs with unique effects.



## ■ Point-and-shoot exposure mode

AUTO

### **AUTO mode (P. 28, 51)**

Camera automatically controls all the exposure settings. Suitable for taking pictures right away.



### **Portrait mode (P. 37)**

Use this mode to take portraits. The background is blurred to accentuate your main subject.



### **Landscape mode (P. 37)**

Use this mode to take pictures of distant scenes. The overall landscape will be sharply focused.



### **Close-Up mode (P. 37)**

Use this mode to take up-close pictures of subjects such as flowers or insects.



### **Sports Continuous mode (P. 38)**

Use this mode to freeze the motion of fast-moving subjects. Continuous shooting is also possible with this mode.



### **Night Scene mode (P. 38)**

Use this mode for subjects with an evening or night background.



# Start Shooting Immediately

- 1** Open the battery chamber and install batteries while the camera's power is off (page 16).

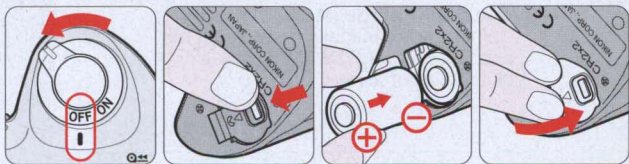

- 2** Attach the lens and turn the power switch on (page 18).

- With CPU Nikkor lens other than G-type, set the lens aperture to its minimum and lock.

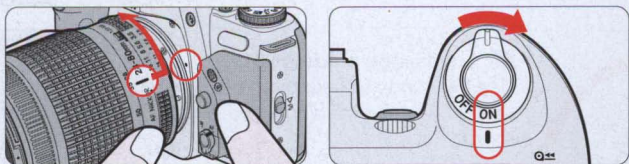

- 3** Open the camera back and install the film (page 20).

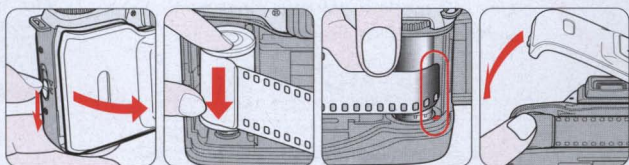

- 4** Set the focus mode selector to AF (autofocus) (page 26).

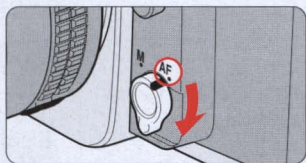

**5** Set the exposure mode dial to  (AUTO mode) (page 28).

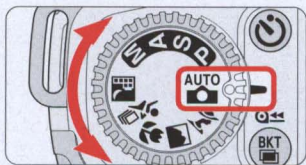

**6** Hold the camera properly, compose frame and focus by lightly pressing the shutter release button (page 30).

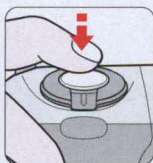

**7** Confirm focus indicator ● appears without blinking and slowly depress the shutter release button (page 32).

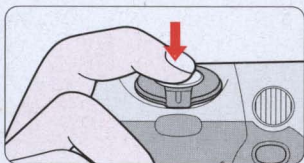

**8** Film starts to rewind automatically when it reaches the end of the roll (page 33).

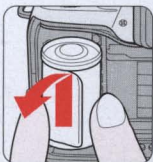
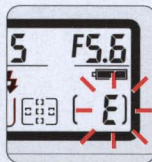
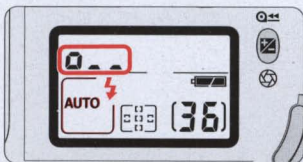





# PREPARATION



This section introduces the various operations necessary before you start shooting.

- Install batteries and check battery power
  - Mount lens
  - Load film
  - Set date and time (N65QD only)
  - About shutter release button
- 

# 1 Install Batteries and Check Battery Power

Use two CR2-type 3V lithium batteries. (For other power sources, see page 94.)

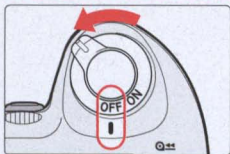

**1** Turn the power switch off and open the battery chamber cover by sliding the battery chamber cover lock lever toward indicated direction.

- When replacing batteries, be sure to turn the power switch off and replace both batteries at the same time. Always use fresh batteries of the same brand.

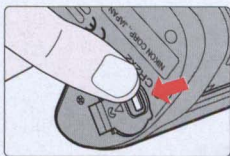

## NOTE: Storing batteries

Keep the batteries out of children's reach. If swallowed, contact a doctor immediately. (For "Notes on Batteries", see page 98.)

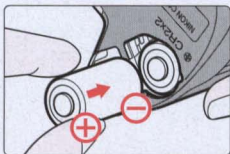

**2** Insert batteries with the  $\oplus$  and  $\ominus$  ends positioned as marked inside the battery chamber, then firmly close the battery chamber cover.

- Incorrect positioning of  $\oplus$  and  $\ominus$  poles may damage the camera.

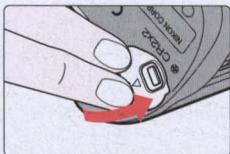

## Check points



- We recommend that you take spare batteries with you, especially when traveling.
- For the number of film rolls that can be shot with fresh batteries, see page 110.

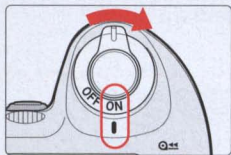

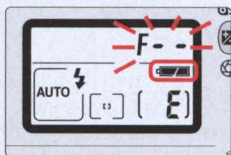

### 3 Turn the power switch on and confirm battery power with the indication.



-  appears: Sufficient battery power.
-  appears: Batteries are nearing exhaustion. Have a fresh set ready. (Viewfinder indications turn off when you release your finger from shutter release button after taking the picture.)



blinks: Batteries are exhausted. Replace batteries. (Shutter locks.)

- Shutter speed and aperture indications in the LCD panel automatically turn off 5 sec. after the power switch is turned on and the camera remains unused. (All indications in the viewfinder turn off.)

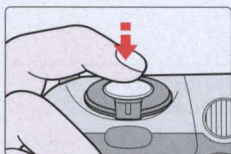

### 4 Lightly press the shutter release button to activate the exposure meter.

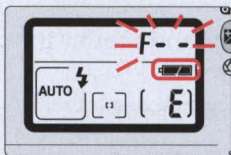

- Lightly pressing the shutter release button reactivates the exposure meter and indications in the LCD panel and viewfinder for approx. 5 sec. See page 24 about the shutter release button.

#### LCD panel when the power switch is off

When the power switch is turned off with batteries installed, the frame counter display remains on in the LCD panel.

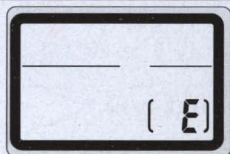

# 2 Mount Lens

Turn the power switch off and mount the lens to the camera body.

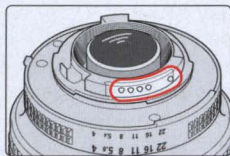

CPU contacts of CPU  
Nikkor lens

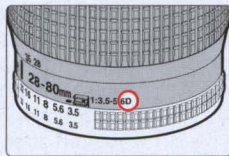

① CPU Nikkor lens  
other than G-type

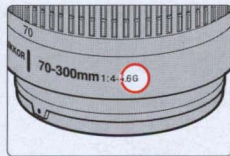

② G-type Nikkor lens

## 1 Check the lens type.

- ① CPU Nikkor lenses other than G-type (Illustration is D-type Nikkor lens), with aperture ring
- ② G-type Nikkor lens, without aperture ring

### G-type Nikkor lens

The G-type Nikkor lens has no aperture ring; aperture should be selected from camera body. Unlike other CPU Nikkor lenses, aperture does not need to be set to minimum.

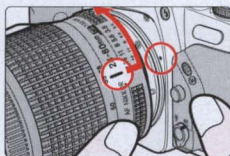

## 2 Turn the power switch off and mount the lens to the camera body.

**With CPU Nikkor lens with aperture ring (other than G-type)**

Position lens in the camera's bayonet mount so that the mounting indexes on lens and camera body are aligned, then twist lens counterclockwise until it locks into place. (Be sure not to touch the lens release button.) And then, **set the lens aperture to its minimum and lock.**

- When the lens is not set to its minimum aperture setting and the power switch is turned on, **fE** blinks in the LCD panel and viewfinder and the shutter cannot be released.



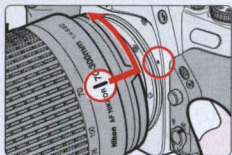

### With G-type Nikkor lens

Position lens in the camera's bayonet mount so that the mounting indexes on lens and camera body are aligned, then twist lens counterclockwise until it locks into place. (Be sure not to touch the lens release button.)

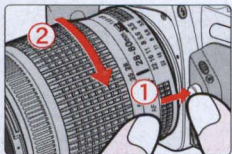

## 3 Detaching the lens.

- Push and hold the lens release button, then turn the lens clockwise to detach the lens.

### When camera is left unattended without lens

When you leave the camera unattended without a lens attached, be sure to attach the supplied body cap (page 3), or optional body cap BF-1A. (BF-1 body cap cannot be used.)

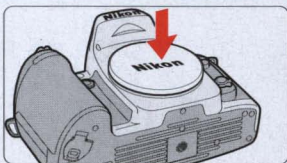

### NOTE: Non-CPU Nikkor lens

When a non-CPU Nikkor lens is attached and the power switch is turned on, F- - blinks in the LCD panel and viewfinder, and the shutter cannot be released (except in Manual exposure mode). See page 90 for a non-CPU lens.

### Check points

- Use a D- or G-type AF Nikkor lens to utilize all of this camera's functions. (See page 88 for Lens Compatibility.)
- Make sure to turn the power switch off when attaching/detaching the lens.
- Avoid direct sunlight when attaching/detaching the lens.

# 3

## Load Film

Turn the power switch on and load DX-coded film. With DX-coded film, film speed will be set automatically (ISO 25-5000). Closing the camera back after loading film automatically advances the film to the first frame.

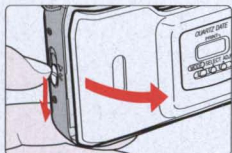

- 1 Turn the power switch on, open the camera back by sliding the camera back lock release lever and load film.

- Film cartridge can be loaded smoothly if inserted from the bottom.

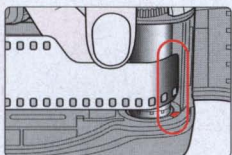
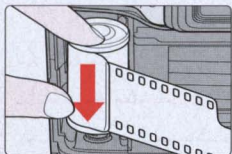

- 2 Pull film leader across to red index mark.

- Do not insert the film leader beyond the red index mark.
- Hold the film cartridge and ensure film is properly positioned with no slack.

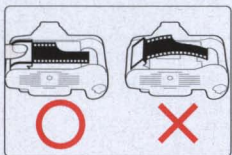

### NOTE: Loading/removing film



Shutter curtains are very thin. Do not touch the shutter curtains with your finger or the film leader.

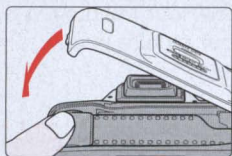

**3** Gently close the camera back until the camera back snaps closed. Film automatically advances to the first frame.

- When *i* appears on the LCD panel, the film has advanced to the first frame.
- When *Err* and *E* in the LCD panel and *Err* in viewfinder blink, film is not properly installed. Open the camera back again and reload film.
- Frame number display remains when the power switch is off.

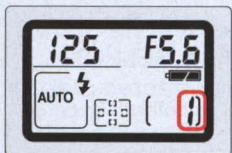

### DX-coded film

With DX-coded film, film speed will be set automatically between ISO 25 to ISO 5000. Film speed is set to ISO 100 with non-DX-coded film.

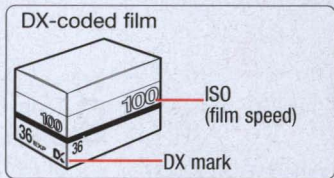

### Check points

- Avoid direct sunlight when changing film outdoors.
- You can check the number of available exposures on the film roll and film speed through the film confirmation window.
- Infrared films cannot be used with this camera since an infrared sensor is used for the detection of the film frame position.

# 4 Set Date and Time (N65QD only)

This camera allows you to imprint Year/Month/Day, Day/Hour/Minute (24-hour clock), Month/Day/Year or Day/Month/Year on your picture in any exposure mode. (For imprinting date/time, see page 39.)

## ■ Adjusting date and time (Example: year 2001, January 15)

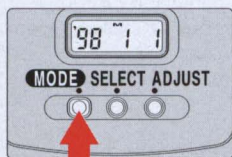

**1** Push MODE button to select one of the date or time displays. Push SELECT button so section to be corrected starts blinking.

- Date cannot be set in Day/Hour/Minute display. To set date, select Year/Month/Day, Month/Day/Year or Day/Month/Year.
- Set the time in Day/Hour/Minute display.

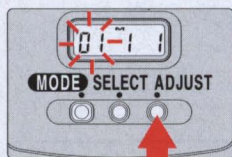
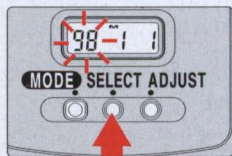

**2** Push ADJUST button to change the blinking numbers and after correction, push SELECT button until the numbers stop blinking.

- Each time you push the ADJUST button, year section moves up from 98 to 49 (back to 98 after 49).
- To change the numerical indication rapidly, hold the ADJUST button down for more than 1 sec.
- Push SELECT button until the date/time display stops blinking. When the imprint indicator — appears in the data imprint LCD panel, the setting is complete.

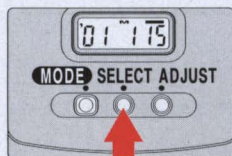

### NOTE: Battery requirements for imprinting

Imprinting of date/time requires one CR2025 3V lithium battery separate from the batteries required for the camera body. Battery life is approx. 3 years. When the imprinting on the photo appears faded and/or the display of the data imprint on the LCD becomes faint or disappears, this indicates low battery power. Replace the battery (making sure to set correct date/time after changing battery).

## ■ Changing battery for imprinting

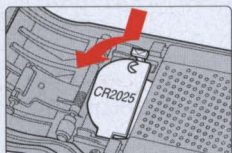

- 1 Open camera back, remove the battery chamber cover for imprinting and then remove the used battery.

- Use a pointed object to remove the battery.

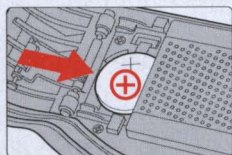
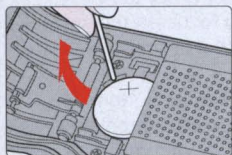

- 2 Insert a new CR2025 3V lithium battery with  $\oplus$  side facing up. Attach the battery chamber cover.

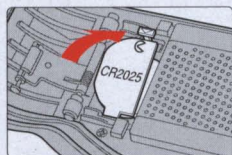

### NOTE: Storing batteries

Keep the batteries out of children's reach. If swallowed, contact a doctor immediately. (For "Notes on Batteries", see page 98.)

# About Shutter Release Button

Lightly pressing the shutter release button and holding it halfway down activates the camera's exposure meter and pressing it all the way down releases the shutter.

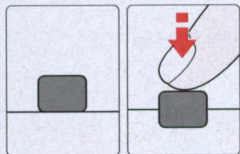

Before  
pressing

Lightly  
pressing

## 1 Lightly press the shutter release button.

- When the focus mode selector is set to AF (autofocus), camera starts to focus on the subject when the shutter release button is lightly pressed (page 30).
- Lightly pressing the shutter release button activates the indications in the LCD panel and viewfinder (for approx. 5 sec. from removal of finger). (See page 17 for the exposure meter.)

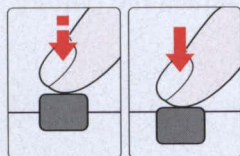

Lightly  
pressing

Fully  
depressing

## 2 Fully depress the shutter release button.

- Fully depressing the shutter release button releases shutter and film automatically advances to the next frame.

### **NOTE: Camera shake**

Pressing the shutter release button abruptly can result in picture blur. Make sure to press the shutter release button slowly.



# BASIC OPERATION

This section features the settings for most common picture-taking situations using AUTO mode (AUTO) to enable easy operation even for the inexperienced beginner.

Shooting modes/functions explained in this section are as follows:

Lens attached	D-type AF Nikkor
Focus mode	AF (autofocus)
Focus Area	Dynamic AF Mode with Closest-Subject Priority*
Exposure metering system	Six-segment 3D Matrix Metering*
Exposure mode	AUTO mode (AUTO)
Flash sync mode	Front-Curtain Sync (⚡)*

\* Automatically set when AUTO mode is selected.

Set focus mode to AF (autofocus). (See page 44 for details.)

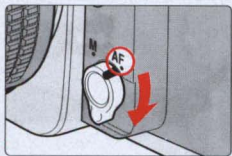



Turn the power switch on and set the focus mode selector to AF (autofocus).

- Make sure to turn the focus mode selector until it clicks into position.
- To focus, lightly press the shutter release button (page 24).

#### NOTE: AF focus mode

Do not rotate the lens focusing ring manually when the focus mode selector is set to AF.

#### Dynamic AF Mode with Closest-Subject Priority

Dynamic AF Mode with Closest-Subject Priority automatically focuses on the subject located closest to any of five focus areas (page 46). If the subject moves from the selected focus area before focus is achieved, camera automatically focuses on the subject determining the data from the other focus areas. When the exposure mode is set to  (AUTO mode, page 51) or to any Vari-Program (page 36) (except  Close-Up mode), the N65/N65QD automatically selects Dynamic AF Mode with Closest-Subject Priority for easy operation, making it unnecessary to switch the focus area.

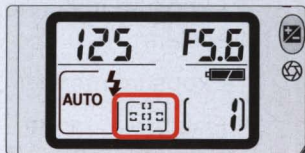
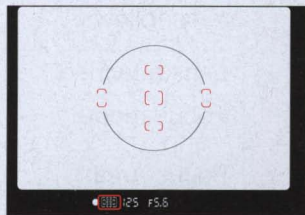

## ■ Situations where autofocus may not work as expected

Autofocus may not work as expected in the following situations. In such situations, focus manually using the clear matte field (page 45) or focus on a different subject located at the same distance, use focus lock (page 50) then recompose.

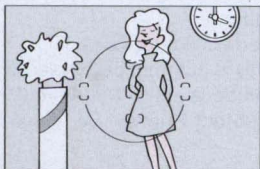

### Low-contrast scenes

For example, where the subject is wearing clothing the same color as a wall or other background.



### Scenes with subjects within the focus brackets located at different distances from the camera

For example, when photographing an animal in a cage or a person in a forest.

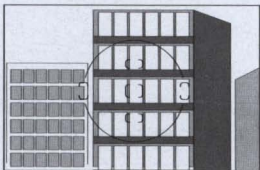

### Patterned subject or scene

For example, building windows.

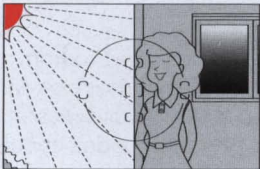



### Scenes with pronounced differences in brightness within the focus brackets

For example, when the sun is in the background and the main subject is in shadow.

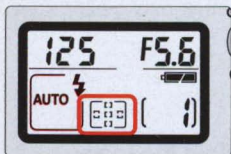
When the exposure mode is set to , the camera automatically controls all the exposure settings.



Set exposure mode to  (AUTO mode).

- When the shutter release button is lightly pressed, shutter speed and aperture are indicated in the LCD panel and viewfinder.
- When the exposure mode is set to  (AUTO mode), **Matrix Metering** is automatically selected.
- Check if the AF Area mode is set to **Dynamic AF Mode with Closest-Subject Priority**. See page 46 for details.

### Matrix Metering (page 42)

The Matrix Meter employed in the N65/N65QD uses a six-segment sensor to achieve superior metering results even in extremely complex lighting conditions. The microcomputer analyzes data including scene brightness and contrast—and subject distance when you use a D- or G-type Nikkor lens (the **3D Matrix Meter** is performed)—and makes the calculations

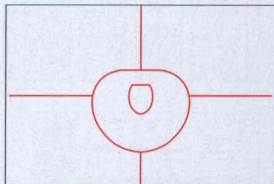







necessary to assure correct exposure. This camera automatically selects Matrix Metering in all exposure modes except Manual exposure mode (page 58).

### ■ About exposure mode

Four exposure modes besides  (AUTO mode) and five Vari-Program modes are available with this camera. Utilizing the characteristics of each exposure mode, effective results can be achieved with various types of subjects or shooting situations. And the five Vari-Program modes enable you to easily choose proper exposure controls by simply selecting the desired mode for various shooting situations.

See each reference page for operating instructions and details.

Symbol	Exposure mode	Characteristics/Shooting situations
	AUTO mode P. 51	The easiest exposure mode for general shooting. Camera controls shutter speed and aperture automatically depending on the subject's brightness—allowing you to freely take pictures, concentrating only on the shutter release opportunity.
Vari-Program	 Portrait mode P. 37	Use this mode to take portraits. The background is blurred to accentuate your main subject.
	 Landscape mode P. 37	Use this mode to take pictures of distant scenes. The overall landscape will be sharply focused.
	 Close-Up mode P. 37	Use this mode to take up-close pictures of subjects such as flowers or insects. Your close-ups will be taken with an artistically blurred background.
	 Sports Continuous mode P. 38	Use this mode to take sports pictures. Using a fast shutter speed, it freezes the motion of fast-moving subjects to create exciting action photos. Continuous shooting is possible with this mode.
	 Night Scene mode P. 38	Use this mode for subjects with an evening or night background. This mode captures all lighting in the scene, including the foreground subject which is illuminated by the flash, and the background. When flash is canceled, a natural-looking night scene or twilight scene can be captured.
<b>P</b>	Auto-Multi Program P. 52	Camera controls shutter speed and aperture automatically, while allowing you to make other settings, such as Flexible Program (page 53) or Exposure Compensation (page 61).
<b>S</b>	Shutter-Priority Auto P. 54	You set desired shutter speed, and the camera selects the correct aperture. Freeze the motion of a moving subject using a fast shutter speed or blur the subject using a slower speed.
<b>A</b>	Aperture-Priority Auto P. 56	You set the desired aperture, and the camera selects the correct shutter speed. Lets you determine depth of the in-focus area, so you can choose whether near or far subjects are in sharp focus, or whether foreground or background is to be blurred.
<b>M</b>	Manual P. 58	Shutter speed and aperture are set manually. Suitable for situations where it is difficult to attain the desired effect using other exposure modes. Long Time exposure is possible with this exposure mode.

# 3

## Hold Camera and Focus

Lightly pressing the shutter release button automatically focuses the camera on the subject and when the subject is in focus, causes ● to appear in the viewfinder.



### 1 Hold the camera properly.

- Keep your elbow propped against your body for support.
- Stand with one foot forward a half step and keep your upper body still.
- Grasp the camera handgrip with your right hand and use your left hand to cradle the camera (or lens).

#### NOTE: Camera shake

Camera shake is likely to occur when the camera is not held steady or with slow shutter speed. The Speedlight automatically fires in dark conditions (where slow shutter speed is required) in  or Vari-Program with this camera but always remember to hold the camera correctly.



### 2 Compose frame, center focus brackets on your subject, and focus by lightly pressing the shutter release button.

- Compose frame so that the subject to be focused is located closest at any of five focus areas and lightly press the shutter release button. When the Dynamic AF Mode with Closest-Subject Priority (page 26, 46) is set, camera automatically maintains focus on the subject located closest to any of five focus areas.

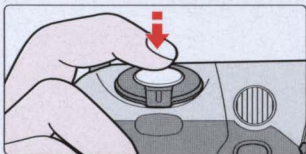









- When shutter release button is lightly pressed, the camera focuses automatically and focus indicator appears or blinks as follows.
  - appears: Subject is in focus.
  - blinks: Unable to focus using autofocus.
- With dark subjects, the camera's AF-Assist Illuminator (page 48) is automatically activated to guide autofocus. See page 44 for details on focusing.



### NOTE: Composing frame

This camera's viewfinder frame shows approximately 89% of the image actually exposed on the film frame. Therefore, the actual exposed frame is somewhat larger than the image you see through the viewfinder. Note that the edges of a negative film are partially cropped by most labs.

### Built-in Speedlight

When the subject is dark or backlit (except in  or ) and the shutter release button is lightly pressed, the built-in Speedlight automatically pops up in  (AUTO mode) or Vari-Program (, , ,  or ). See page 76 for details.

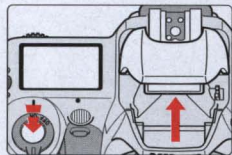

### Check points

- Diopter adjustment (page 67) enables you to see more clearly through the viewfinder.
- To take a picture of a subject outside the focus area, shift the focus area (page 46) or use focus lock (page 50).
- In situations where autofocus may not work as expected, see page 27.

# 4

## Release Shutter

Confirm that ● (in-focus indicator) appears in the viewfinder, then slowly, fully depress the shutter release button. With a moving subject, Continuous Servo AF (page 44) activates and camera continuously focuses on the subject.

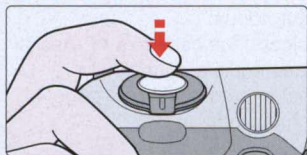

### 1 Confirm indications in the viewfinder while lightly pressing the shutter release button.

- When the subject is dark or backlit and shutter release button is lightly pressed, the built-in Speedlight automatically pops up and starts charging (pages 34, 76).



### 2 Confirm that focus indicator ● appears and slowly depress the shutter release button.

- After the shutter is released, the film automatically advances to the next frame and the next shot can be taken.

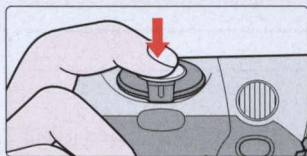



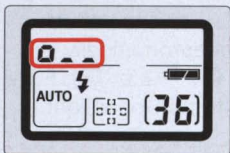

### 3 Film starts to rewind automatically when film reaches the end of the roll.

- The frame counter counts down until rewind is complete.
- Pictures taken on frames beyond the indicated number of the exposures for the film roll may be discarded in the process of developing.

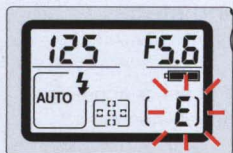

### 4 Confirm that film is completely rewound, then remove film cartridge.









- Film is completely rewound when the frame counter shows blinking E in the LCD panel. (E appears without blinking when the exposure meter is off.) Make sure the film is completely rewound (E is blinking in the LCD panel), open the camera back away from sunlight and remove the film cartridge by tilting it to one side.



#### Check points

- If any other warning indications appear, see page 99.
- For mid-roll rewind, see page 66.

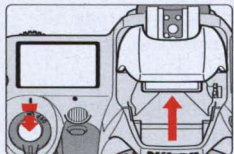

# Using Built-In Speedlight

When the subject is dark or backlit (except in  or ) and the shutter release button is lightly pressed, the built-in Speedlight automatically pops up in  (AUTO mode) or Vari-Program (, , ,  or ). Fully depress the shutter release button to take pictures with the Speedlight.

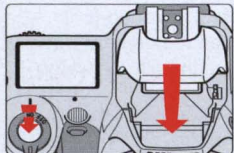

**1** When the subject is dark or backlit and the shutter release button is lightly pressed, the built-in Speedlight automatically pops up and starts charging.



- When the Speedlight is ready to fire,  appears without blinking in the viewfinder (when the camera's meter is on).
- When you want to take a picture without the flash, close the Speedlight until it clicks shut while lightly pressing the shutter release button. (When the flash is canceled in this manner, as long as the shutter release button is kept lightly pressed, flash is canceled for subsequent shots. When you remove your finger from the shutter release button and shutter release button is lightly pressed again, the built-in Speedlight pops up again and flash starts charging.)
- To cancel the flash for subsequent shots, select the Flash Cancel mode (page 79).
- When the subject is backlit in  or  mode, built-in Speedlight does not fire automatically.



## **NOTE: Continuous use of built-in Speedlight**

After continuous use of the built-in Speedlight, it may stop firing to protect the firing tube. Wait for a while before using the Speedlight again.

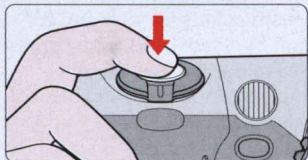

**2** Confirm  in viewfinder, then compose, focus and take the picture with flash by fully depressing the shutter release button.



- The shutter cannot be released unless  appears without blinking in the viewfinder.
-  blinks in the viewfinder approx. 3 sec. after full flash output. If this happens, underexposure may have occurred. Check the flash shooting distance range (page 84) and shoot again.
- With dark subjects, the camera's AF-Assist Illuminator is automatically activated to guide autofocus. See page 48 for details.

### Built-in Speedlight and Matrix Balanced Fill-Flash

- The built-in Speedlight offers an angle of coverage of 28mm lens with a guide number of 12/40 (ISO 100, m/ft.). When a wide-angle lens of less than 28mm focal length is used in flash photography using the built-in Speedlight, the flash may not reach the peripheral area and may result in a dark picture.
- Using CPU Nikkor lenses such as a D- or G-type Nikkor lens enables use of **Matrix Balanced Fill-Flash**. Analyzing the brightness and contrast level derived from Matrix Metering, the **Matrix Balanced Fill-Flash** ensures proper exposure of the main subject and background, while providing adequate flash output to create natural-looking flash photography. See page 76 for details.

### Check points

- Be sure to remove (or store) the lens hood before flash shooting.
- Some lenses have limitations using the built-in Speedlight and may cause vignetting (a shadow may appear within the frame) (page 85).
- Normal Front-Curtain Sync flash mode is introduced in this section. Various flash sync modes are also available. For details, see page 78.

# Shooting with Vari-Program

Vari-Program gives you the option to choose from Portrait, Landscape, Close-Up, Sports Continuous or Night Scene mode—designed for specific picture-taking situations and photographic images.





**1** Set the exposure mode dial to the desired Vari-Program, then lightly press the shutter release button.

- Center the focus brackets on your subject (where you want the focus) and lightly press the shutter release button. The camera focuses automatically and focus indicator appears or blinks as follows.

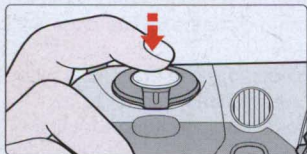
- appears: Subject is in focus.
- (with radiating lines) blinks: Unable to focus using autofocus.



**2** Confirm that focus indicator ● appears and slowly depress the shutter release button.

- Shutter speed and aperture are automatically determined to suit the selected Vari-Program and are displayed in the LCD panel and viewfinder.
- When the subject is dark or backlit, the built-in Speedlight automatically pops up and fires.
- When the subject is backlit in  Sports Continuous or  Landscape mode, the Speedlight does not fire automatically.

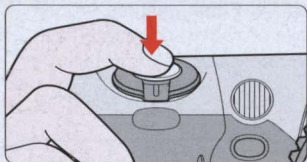

## NOTE: Vari-Program

Flexible Program (page 53), Auto Exposure Bracketing (page 62) and Multiple Exposure (page 64) cannot be performed in Vari-Program. When using the flash in Vari-Program, the Flash Sync modes (page 78) automatically change according to each mode selected.



## Portrait mode

Use this mode whenever you are taking pictures of people. It creates a blurred background to accentuate your main subject.

- 85mm to 200mm telephoto lenses with large maximum apertures are recommended.
- Distancing the main subject and the background emphasizes the effect.



## Landscape mode

Use this mode whenever you're taking a picture of a distant scene. The overall picture, whether the subject is near or far, is sharply focused.

- A wide-angle lens is suited to capturing a wide view of the landscape.
- In some shooting situations, slow shutter speed is selected. To avoid camera shake, use a tripod.
- Use of the Speedlight is not recommended for only landscape shots. To cancel flash, set the flash sync mode to Flash Cancel (🚫) (page 79) or close the built-in Speedlight while lightly pressing the shutter release button.



## Close-Up mode

Use this mode when you are taking pictures up close. It creates a blurred background to accentuate your main subject. Useful in taking close-ups of subjects such as flowers or insects.

- Effect is maximized at minimum focusing distance of the lens in use. When using a zoom lens, use telephoto zoom position.
- For more professional uses, Micro-Nikkor lenses are recommended.
- In some shooting situations, slow shutter speed is selected. To avoid camera shake, use a tripod.
- Dynamic AF Mode and center focus area are automatically selected (page 46).



## : Sports Continuous mode

Use this mode to freeze action. It uses a fast shutter speed suitable for stop-action photography. In Sports Continuous mode, Continuous Servo AF (page 44) is automatically activated and the camera continues to focus on the subject without Focus lock (page 50). Also, the shutter is released repeatedly as long as the shutter release button is fully depressed.

- 80mm to 300mm telephoto lenses are recommended.
- Use of ISO 400 or faster film speed is recommended.
- A tripod is recommended when using a telephoto lens to avoid camera shake.
- Continuous shooting is not possible when the built-in Speedlight is in up position.



## : Night Scene mode

Use this mode for subjects with an evening or night background. Night Scene mode captures all the lighting in the scene, including the foreground subject and background. When the flash is canceled, it allows you to capture the beauty of nighttime or twilight scenes.

- Use of ISO 400 or faster film speed is recommended.
- To avoid camera shake, use a tripod.
- To cancel flash, set the flash sync mode to Flash Cancel  (page 79) or close the built-in Speedlight while lightly pressing the shutter release button.



# Imprinting Date/Time (N65QD only)

You can imprint the following date information on your picture:  
Year/Month/Day, Day/Hour/Minute, Month/Day/Year or Day/Month/Year.  
See page 22 to set date and time.

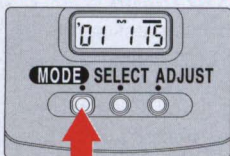

## 1 Push MODE button to select available imprinting displays. (Example: year 2001, January 15, 15:30)

- Each time you push the MODE button the display changes as follows:

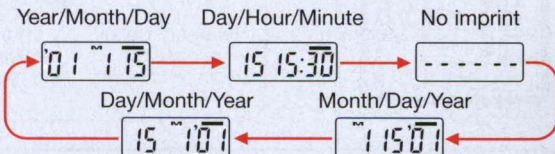

- The data displayed on the data imprint LCD will be imprinted on the picture. Select - - - - (no imprint) to cancel data imprint. Compatible film speeds for data imprinting are ISO32-3200.

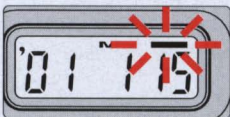

## 2 Compose picture, focus and fully depress the shutter release button to take a picture with the imprinted date/time.

- Data imprint indicator  blinks for approx. two to three sec. immediately after the shutter is released (when film is loaded).

### Imprinted date/time



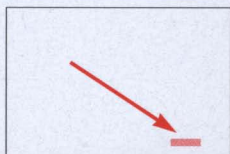

The illustration at right indicates the position of the imprinted date/time on the film. It may be difficult to read against bright colors such as white or reddish hues.

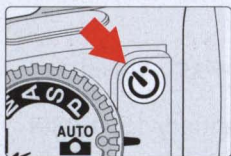

# Self-Timer Operation

You can use the self-timer when you want to be in the photograph.



- 1 Press  (self-timer) button and confirm that  appears on the LCD panel. (Or, rotate the Command Dial while pressing the  button until  appears on the LCD panel.) The display changes as follows:

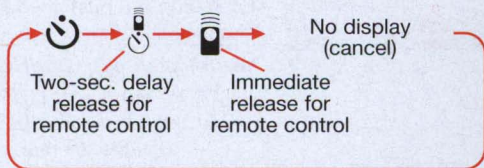
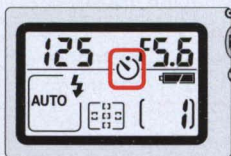





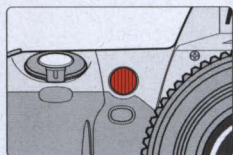
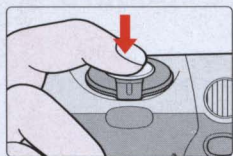

## Check points

- Use a tripod or place the camera on a stable surface before using the self-timer.
- To shoot in an exposure mode other than Manual, cover the eyepiece with the supplied eyepiece cap DK-5 (page 3) or with your hand before pressing the shutter release button to prevent interference from stray light and achieve correct exposure.
- Do not stand in front of the lens when setting the self-timer in autofocus mode.





## 2 Compose picture, focus by lightly pressing the shutter release button and fully depress the shutter release button.

- Self-timer shooting cannot be performed unless the camera's shutter can be released (i.e. when subject cannot be brought into focus with autofocus).
- Once the self-timer is activated, the shutter will release in 10 seconds. The self-timer lamp will blink for 8 sec. and then illuminate for 2 sec. before the shutter is released. When Red-Eye Reduction (page 79) is set, self-timer activates and the self-timer/red-eye reduction lamp lights for 1 sec. before the shutter releases at the same output level as the normal Red-Eye Reduction function.
- To cancel the self-timer, either turn the power switch off, press the  button until  and  disappear in the LCD panel, or rotate the Command Dial while pressing the  button until  and  disappear in the LCD panel.
- To cancel the self-timer during self-timer operation, turn the power switch off or press the  button again.

# About Metering Systems and Exposure

Metering systems and exposure are important factors for taking pictures. Knowing the characteristics of each factor helps you widen your photographic expression.

## ■ Metering Systems

As the proper combination of shutter speed and aperture for correct exposure is determined according to subject brightness and film sensitivity, measuring subject brightness is very important.

In general, brightness inside the viewfinder is not uniform. The N65/N65QD provides two metering systems: **Matrix Metering** (page 28) and **Center-Weighted Metering** (page 58). With **Matrix Metering**, data on scene brightness is detected by the six-segment Matrix sensor. With **Center-Weighted Metering**, most of the meter's sensitivity is concentrated on the 12mm-diameter center circle in the viewfinder. With the N65/N65QD, **Matrix Metering** is automatically selected when the exposure mode is set to other than Manual and **Center-Weighted Metering** is selected with Manual exposure mode.

Using D- or G-type Nikkor lenses, the N65/N65QD camera performs **3D Matrix Metering** by adding distance information to determine correct exposure.

## ■ Exposure

Light from the subject passes through the lens and exposes the film. Light reaching the film is controlled by the shutter speed and aperture. The proper combination of shutter speed and aperture for subject brightness and film sensitivity results in the correct exposure.

The N65/N65QD's AUTO mode (page 51), Auto-Multi Program (page 52) and Vari-Program (page 36) automatically control shutter speed and aperture. In Shutter-Priority Auto exposure mode (page 54), you can manually set shutter speed and the camera automatically sets the proper aperture. In Aperture-Priority Auto exposure mode (page 56), you can manually set aperture and the camera automatically sets the proper shutter speed. In Manual exposure mode (page 58), you manually set both shutter speed and aperture.





# DETAILED OPERATION



This section features detailed descriptions of camera functions and advanced operations.

- Focus mode
- Focus area
- AF-Assist Illuminator
- Focus lock
- Shooting in each exposure mode
- Exposure Compensation
- Auto Exposure Bracketing
- Multiple Exposure
- Film rewind
- Diopter adjustment/Viewfinder accessories
- Depth-of-field preview
- Remote control operation (optional)
- Available mode combinations

Two focus modes, autofocus using the Auto-Servo AF (Single Servo AF and Continuous Servo AF) and Manual focus, are available with this camera.

## ■ Autofocus

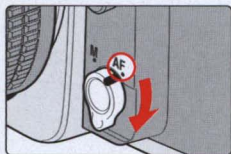

- With the focus mode selector set to **AF**, lightly pressing the shutter release button automatically focuses the camera on the subject at the focus area (page 46) and causes ● to appear in the viewfinder.

## ■ Auto-Servo AF

Camera automatically chooses Single Servo AF or Continuous Servo AF operation according to the subject status, i.e. stationary or moving (including directional information).

### • Single Servo AF

The shutter can be released when the focus indicator ● appears in the viewfinder. Once focused on a subject, keeping the shutter release button lightly pressed locks focus (Focus Lock, page 50). However, if the subject starts moving, Focus Lock is deactivated, and the focus mode automatically switches to Continuous Servo AF.

### • Continuous Servo AF

Continuous Servo AF is automatically activated when the subject is moving. The shutter can be released when the focus indicator ● appears in the viewfinder; however, focus is not locked and the camera continues to focus on the subject until shutter release. With a moving subject, Focus Tracking (page 104) is activated and the camera continuously focuses on the subject. Also, N65/N65QD will continue to focus firmly on a main subject with Lock-On™.

- When  Sports Continuous mode is selected, Continuous Servo AF is automatically activated and the camera continuously focuses on the subject.

### About Lock-On™

Lock-On™ Autofocus keeps focus firmly on a main subject even if some other object momentarily blocks it in the viewfinder.

## Manual focus

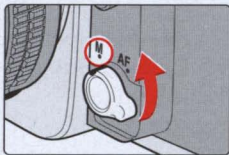

- Set the focus mode selector to **M**. Look through the viewfinder and rotate the lens focusing ring until the image appears sharp on the clear matte field in the viewfinder. The shutter can be released whether or not the subject is in focus and regardless of the focus indicator status.
- Use Manual focus in situations where autofocus may not work as expected (page 27) or lens other than AF Nikkor (page 89) is attached.
- When using a lens with the A-M select function, set the switch/ring to M to focus manually. If M/A (autofocus with manual priority) is available with your lens, Manual focus is possible either with the switch/ring set to M or M/A. See the instruction manual of your lens for details.

### Manual focus using Electronic Rangefinder

Set the focus mode selector to **M**. The focus can be confirmed with ● indication in the viewfinder. The Electronic Rangefinder works with most Nikkor lenses (including AF Nikkors when operated manually) having a maximum aperture of f/5.6 or faster.

Lightly press the shutter release button and while the meter is on, rotate the lens focusing ring until ● appears in the viewfinder. The shutter can be released anytime. The Electronic Rangefinder can be activated with any of five focus brackets selected as the focus area (page 46).

# Focus Area

This camera's five focus areas cover a wide frame area, and you can select among them, depending on the subject's position in the frame or your desired composition. When the focus mode is set to **AF** (autofocus, page 44), you can select either **Dynamic AF Mode with Closest-Subject Priority**, where the camera automatically selects the focus area, or **Dynamic AF Mode**, where you select the desired focus area.

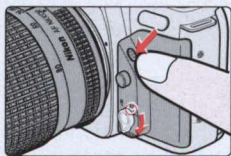

Set the focus mode selector to **AF** (autofocus) and rotate the Command Dial while pressing the focus area button to select focus area.

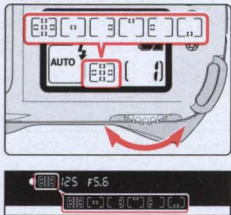

- Rotating the Command Dial while pressing the focus area button changes the display as follows:

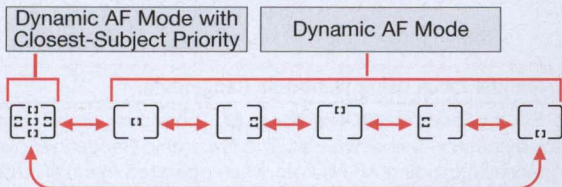

- Confirm selected focus area in the LCD panel and viewfinder.

## • Dynamic AF Mode with Closest-Subject Priority

Dynamic AF Mode with Closest-Subject Priority automatically maintains focus on the subject located closest to any of five focus areas and focus is locked once it is achieved. If the subject moves from the selected focus area before focus lock, the camera automatically focuses on the subject determining the data from the other focus areas. When **AUTO** mode or Vari-Program (except **Close-Up** mode) is selected, Dynamic AF Mode with Closest-Subject Priority is automatically selected.

## • Dynamic AF Mode

Focus is obtained at the selected focus area and focusing is locked (as long as the shutter release button is lightly pressed) once it is achieved. If the subject moves from the selected focus area before focus lock, the camera automatically focuses on the subject determining the data from the other focus areas. When **Close-Up** mode is selected, Dynamic AF Mode and center focus area are automatically selected.

## ■ When focus mode is set to Manual

**Single Area Mode** is automatically selected when the focus mode selector is set to **M** (manual, page 45).

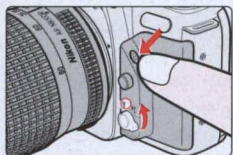

Set the focus mode selector to **M** (manual) and rotate the Command Dial while pressing the focus area button to select focus area.

### • Single Area Mode

Focus is obtained only at the selected focus area when using the manual focus with Electronic Rangefinder (page 45).

• Rotating the Command Dial while pressing the focus area button changes the display as follows:

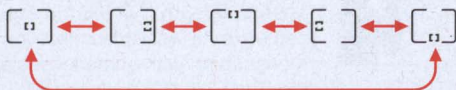
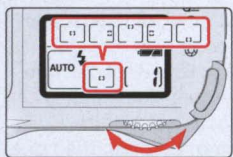

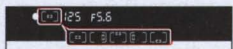

• Confirm selected focus area in the LCD panel and viewfinder.

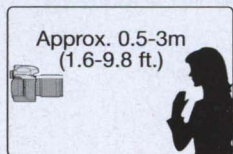
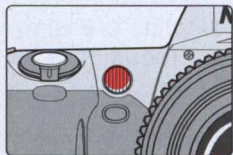

# AF-Assist Illuminator

When the subject is dark and the shutter release button is pressed lightly, the camera's AF-Assist Illuminator automatically turns on and enables autofocus operation in a dark environment.



- AF-Assist Illuminator automatically turns on in the following situations:  
Focus mode is autofocus, AF Nikkor lens is used, subject is dark and center focus area is selected or Dynamic AF Mode with Closest-Subject Priority is activated.
- AF-Assist Illuminator does not turn on in  Landscape mode or  Sports Continuous mode.
- Focal length of the usable AF Nikkor lens is 24-200mm and the distance range of the AF-Assist Illuminator is approx. 0.5-3m (1.6-9.8 ft.). Autofocus using the camera's AF-Assist Illuminator cannot be performed due to vignetting with some lenses at a shooting distance less than 1m (3.3 ft.) (page 49).
- When the optional Speedlight SB-28/28DX, SB-27, SB-26, SB-25 or SB-24 is attached and the conditions for the AF-Assist Illumination are met, the AF-Assist Illuminator of the optional Speedlight automatically turns on. With other optional Speedlights, the camera's Illuminator turns on (page 92).

## NOTE: Continuous use of the AF-Assist Illuminator

When the AF-Assist Illuminator is used continuously, illumination is limited temporarily to protect the firing tube. The illumination restarts after a few moments. Also, when the AF-Assist Illuminator is used repeatedly in a short period of time, be careful not to touch the AF-Assist Illuminator lamp because it may become hot.



## Canceling AF-Assist Illuminator

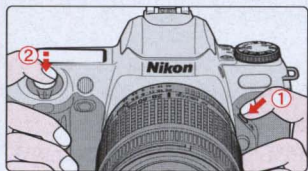

AF-Assist Illuminator automatically turns on in the conditions mentioned on the previous page. To cancel AF-Assist Illuminator (i.e., when the subject feels the illumination is too bright), lightly press the shutter release button while pressing the AF-Assist Illuminator cancel button. However, the correct focus may not be achieved without AF-Assist Illuminator.

## ■ Lenses incompatible with AF-Assist Illuminator

Autofocus using the camera's AF-Assist Illuminator cannot be performed due to vignetting with the following lenses.

### NOTE: Lenses incompatible with AF-Assist Illuminator

- Lens with autofocus using the camera's AF-Assist Illuminator cannot be performed due to vignetting at a shooting distance less than 1m (3.3 ft.).
  - AF Micro 200mm f/4 IF-ED
  - AF-S 17-35mm f/2.8 IF-ED
  - AF 18-35mm f/3.5-4.5 ED
  - AF 20-35mm f/2.8 IF
  - AF 24-85mm f/2.8-4
  - AF 24-120mm f/3.5-5.6 IF
  - AF Micro 70-180mm f/4.5-5.6 ED
- Lens with autofocus using the camera's AF-Assist Illuminator cannot be performed due to vignetting at a shooting distance less than 1.5m (4.9 ft.).
  - AF-S 28-70mm f/2.8 IF-ED at 70mm (usable at approx. 1m [3.3 ft.] or longer at wideangle)
- Lens with autofocus using the camera's AF-Assist Illuminator cannot be performed due to vignetting.
  - AF-S 80-200mm f/2.8 IF-ED
  - AF 80-200mm f/2.8 ED
  - AF VR 80-400mm f/4.5-5.6 ED

# Focus Lock

Focus lock is useful in autofocus shooting when you want to capture a subject that's framed outside of the N65/N65QD's five focus areas, and in situations where autofocus may not work as expected (page 27).



**1** Position the focus area on the subject and lightly press the shutter release button. (For example, when center focus is selected.)

- appears when the subject is in focus and the focus is locked as long as the shutter release button is kept lightly pressed.
- Focus lock cannot be used in  Sports Continuous mode.
- Focus is not locked with a moving subject. To lock focus on a stationary subject which has been moving, remove your finger from the shutter release button and lightly press the shutter release button again.

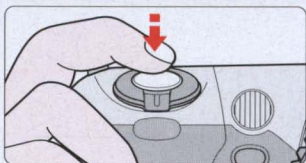

**2** Confirm focus indicator ●, compose while lightly pressing the shutter release button and shoot.

- After you have locked focus, do not change the camera-to-subject distance. If you keep the shutter release button lightly pressed after releasing the shutter, the shutter can be released repeatedly with the same focusing.

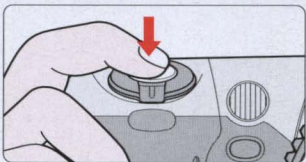

# Shooting in Each Exposure Mode



## : AUTO mode

The simplest exposure mode with this camera. The camera automatically controls exposure. When the subject is dark or backlit, the built-in Speedlight automatically pops up to fire. Recommended for beginner SLR camera users.

-  (AUTO mode) can only be used with a CPU Nikkor lens such as D- or G-type Nikkor (page 88).

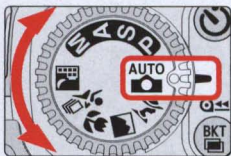

## 1 Set the exposure mode dial to .

- With exposure mode set to , other modes are set as follows:

AF Area Mode: Dynamic AF Mode with Closest-Subject Priority (page 46)

Metering system: Matrix (page 28)

Flash sync mode: Front-Curtain sync (Normal Sync) (page 78)

### Check point

In , Flexible Program, Exposure Compensation, Auto Exposure Bracketing, Multiple Exposure, Slow Sync flash, Red-Eye Reduction with Slow Sync flash and Rear-Curtain Sync flash cannot be used.

### NOTE: Minimum aperture with CPU Nikkor lens (except G-type)

Always set the aperture ring of a CPU Nikkor lens (except G-type) to its minimum (largest f-number). When the lens is not set to its minimum aperture setting, **fE E** blinks in the LCD panel and viewfinder, and the shutter locks.

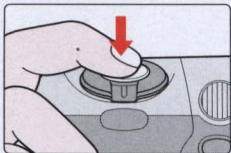

## 2 Compose picture, confirm focus indicator ● and shoot.

- When the subject is dark or backlit, the built-in Speedlight automatically pops up and fires (page 34).
- See page 99 if any warning indication appears in the LCD panel or viewfinder.

# Shooting in Each Exposure Mode—continued



## **P**: Auto-Multi Program

The camera automatically controls exposure to achieve correct exposure in any shooting situation. For more complex shooting, use Flexible Program (page 53), Exposure Compensation (page 61) or Auto Exposure Bracketing (page 62).

- **P** (Auto-Multi Program) can only be used with a CPU Nikkor lens such as D- or G-type Nikkor (page 88).



**1** Set the exposure mode dial to **P**.

### **NOTE: Minimum aperture with CPU Nikkor lens (except G-type)**

Always set the aperture ring of a CPU Nikkor lens (except G-type) to its minimum (largest f-number). When the lens is not set to its minimum aperture setting, **fE** blinks in the LCD panel and viewfinder, and the shutter locks.

### **Difference between (AUTO mode) and P (Auto-Multi Program)**

Although exposure controls are the same, with Auto-Multi Program, you can select functions such as Flexible Program (page 53), Exposure Compensation (page 61), Auto Exposure Bracketing (page 62), Multiple Exposure (page 64), Slow Sync (page 78) or Rear-Curtain Sync (page 78) flash for more flexible shooting. In Auto-Multi Program, however, the built-in Speedlight does not pop up automatically.

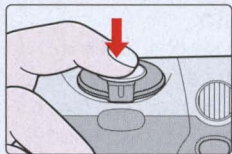

## 2 Compose picture, confirm focus indicator ● and shoot.

- When the subject is too dark or too bright, one of the following warning indications will appear in the viewfinder and LCD panel.
  - **H i**: Use ND filter.
  - **L a**: Use Speedlight.
- If the subject is too dark or backlit, the flash recommended indication **⚡** blinks in the viewfinder when you lightly press the shutter release button. Use the Speedlight (page 80/92).

### Flexible Program

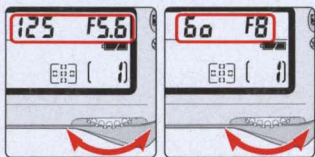

By rotating Command Dial in Auto-Multi Program, you can change the combination of shutter speed and aperture while maintaining correct exposure. With this function, you can shoot in Auto-Multi Program as though shooting in Shutter-Priority Auto or Aperture-Priority Auto. To cancel the Flexible Program,

either change the exposure mode, turn off the power switch, or use the built-in Speedlight (page 80).

# Shooting in Each Exposure Mode—continued



Fast shutter speed 1/500 sec.



Slow shutter speed 1/30 sec.

## **S**: Shutter-Priority Auto

Enables you to manually set the desired shutter speed (30-1/2000 sec.); the camera automatically selects the proper aperture to provide correct exposure. With high shutter speeds, you can freeze the motion of a fast-moving subject; with slower speeds, you can create a motion effect.

- **S** (Shutter-Priority Auto) can only be used with a CPU Nikkor lens such as D- or G-type Nikkor (page 88).



**1** Set the exposure mode dial to **S**.

### **NOTE: Minimum aperture with CPU Nikkor lens (except G-type)**

Always set the aperture ring of a CPU Nikkor lens (except G-type) to its minimum (largest f-number). When the lens is not set to its minimum aperture setting, **fE** blinks in the LCD panel and viewfinder, and the shutter locks.

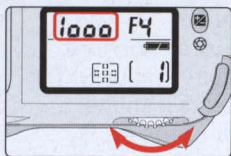

**2** Set the shutter speed (30-1/2000 sec.) with the Command Dial.

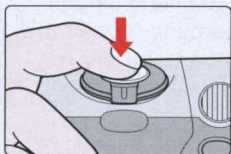

**3** Compose picture, confirm focus indicator ● and shoot.

- When the subject is too dark or too bright, one of the following warning indications will appear in the viewfinder and LCD panel. (Over or underexposure value is indicated with the electronic analog exposure display in the viewfinder.)
  - **H i**: Select higher shutter speed. If the warning indication still remains on, use an ND filter.
  - **L o**: Select slower shutter speed. If the warning indication still remains on, use the Speedlight.
- If the subject is too dark or backlit, the flash recommended indication **⚡** blinks in the viewfinder when you lightly press the shutter release button. Use the Speedlight (page 80/92).

#### Check point

- If -- (Long Time exposure) is selected in Manual exposure mode and the exposure mode is changed to Shutter-Priority Auto without canceling --, -- blinks and the shutter locks. To shoot in Shutter-Priority Auto exposure mode, select shutter speed other than -- by rotating the Command Dial.



Small aperture  $f/22$



Large aperture  $f/2.8$

## A: Aperture-Priority Auto

Enables you to set the desired aperture (lens' minimum to maximum) manually. The camera automatically selects a shutter speed suitable for correct exposure. By varying the aperture, and thus controlling the depth of field (page 74), you can sharpen the background and foreground, or blur the background. In flash photography, varying the aperture changes the flash shooting distance (page 84).

- **A** (Aperture-Priority Auto) can only be used with a CPU Nikkor lens such as D- or G-type Nikkor (page 88).



**1** Set the exposure mode dial to **A**.

### **NOTE: Minimum aperture with CPU Nikkor lens (except G-type)**

Always set the aperture ring of a CPU Nikkor lens (except G-type) to its minimum (largest f-number). When the lens is not set to its minimum aperture setting,  $fE E$  blinks in the LCD panel and viewfinder, and the shutter locks.



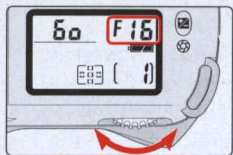

**2** Set the aperture (lens' minimum to maximum) by rotating the Command Dial.



**3** Compose picture, confirm focus indicator ● and shoot.

- When the subject is too dark or too bright, one of the following warning indications will appear in the viewfinder and LCD panel. (Over or underexposure value is indicated with the electronic analog exposure display in the viewfinder.)
  - **H i**: Select smaller aperture (larger f-number). If the warning indication remains on, use an ND filter.
  - **L o**: Select larger aperture (smaller f-number). If the warning indication remains on, use the Speedlight.
- If the subject is too dark or backlit, the flash recommended indication **⚡** blinks in the viewfinder when you lightly press the shutter release button. Use the Speedlight (page 80/92).

# Shooting in Each Exposure Mode—continued



## M: Manual

Enables you to set both shutter speed (30 sec. - 1/2000 sec.) and aperture (lens' minimum to maximum) manually. With electronic analog exposure display in the viewfinder, you can produce various creative effects by adjusting the exposure. Long Time exposure (Time) can be set in Manual exposure mode.

- Non-CPU lenses (page 90) can only be used in Manual exposure mode.



## 1 Set the exposure mode dial to M.

- Metering system automatically switches to **Center-Weighted** from Matrix in Manual exposure mode.
- When a non-CPU Nikkor lens is attached, F- - appears in the LCD panel and viewfinder. Set/confirm aperture with the lens aperture ring. Camera's exposure meter cannot be used. See page 90 for details.

### Center-Weighted Metering

Center-Weighted Metering places special emphasis on brightness within the 12mm-diameter circle in the viewfinder and is thus useful for basing exposure on a specific area of the scene.

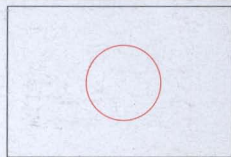

### NOTE: Minimum aperture with CPU Nikkor lens (except G-type)

Always set the aperture ring of a CPU Nikkor lens (except G-type) to its minimum (largest f-number). When the lens is not set to its minimum aperture setting, fE E blinks in the LCD panel and viewfinder, and the shutter locks.

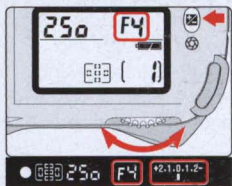
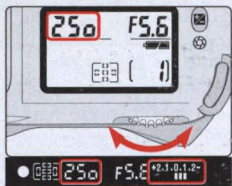

## 2 Set the shutter speed and aperture while checking the electronic analog exposure display in the viewfinder.

- Set the shutter speed (--- and 30-1/2000 sec.) by rotating the Command Dial and aperture (minimum to maximum) by rotating the Command Dial while pressing the aperture button.
- The electronic analog display in the viewfinder indicates the difference between the selected exposure (shutter speed and aperture) and the correct exposure. The electronic analog exposure display blinks when the subject brightness is beyond the camera's exposure range. (Electronic analog exposure display is not available with Long Time exposure.)

The following examples show electronic analog exposure display indications:

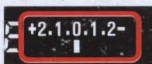

Correct exposure



-1/2 EV



Over +2 EV

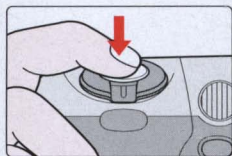

## 3 Compose picture, focus and shoot.

- If the subject is too dark or backlit, the flash recommended indication blinks in the viewfinder when you lightly press the shutter release button. Use the Speedlight (page 80/92).
- The Exposure Compensation cannot be set in Manual exposure mode.

## **Long Time (Time) Exposure**

---

Rotate the Command dial to set the shutter speed indication to - - (next after 30 sec.) to set Long Time (Time) exposure. Depressing the shutter release button once opens the shutter and the self-timer lamp flickers slightly once every 2 sec. during Long Time (Time) exposure. - - and other indications such as aperture are displayed in the LCD panel, but all the indications turn off in the viewfinder. Lightly press the shutter release button again to close the shutter. This function is useful for shooting nighttime scenes or stars. Camera shake can be reduced by using the Self-Timer (page 40), Remote Control (page 69) and tripod. Continuous exposure is possible for approx. 4 hours with a fresh set of batteries. Note that continuous exposure time is reduced when shooting in low temperatures, and Auto Exposure Bracketing (page 62) cannot be performed during Long Time (Time) exposure.

# Exposure Compensation

To modify exposure control (i.e. from the ISO standard), use the Exposure Compensation function. This can be useful when intentionally achieving under or overexposure to obtain a specific photographic effect.

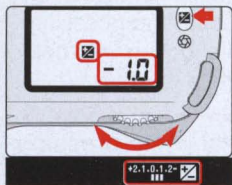

Electronic analog exposure display

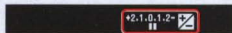

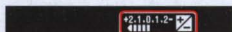

-0.5 EV compensation





+2 EV compensation

**1** Set Exposure Compensation by rotating the Command Dial while pressing the  button until the desired compensation value appears (-2 EV to +2 EV in 1/2 steps).



- When the Exposure Compensation is set,  appears in the LCD panel and viewfinder. The compensation value can be checked by pressing the  button. The electronic analog exposure display also appears as illustrated in the viewfinder when the  button is pressed.
- Normally, you should compensate exposure to the + side when the background is brighter than your main subject, or to the - side when the background is darker.

## Exposure mode with Exposure Compensation

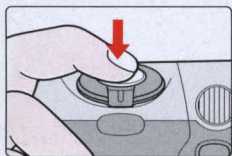
Exposure Compensation can be set in **P** (Auto-Multi Program), **S** (Shutter-Priority Auto), **A** (Aperture-Priority Auto) and Vari-Program. Once the Exposure Compensation is set in each **P**, **S** or **A** exposure mode, compensation remains in that exposure mode. Changing the exposure mode to **M**,  AUTO or Vari-Program temporarily cancels the compensation. Exposure Compensation set in Vari-Program is canceled when exposure mode is changed. The Exposure Compensation cannot be set in  AUTO or **M** exposure mode.





**2** Compose picture, confirm focus indicator  and shoot.

- To cancel Exposure Compensation, rotate the Command Dial while pressing the  button to reset the compensation value to . In Vari-Program, changing the exposure mode also cancels the Exposure Compensation. (Turning the power switch off does not cancel the Exposure Compensation.)

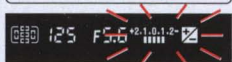
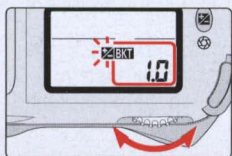
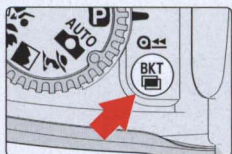

# Auto Exposure Bracketing

Auto Exposure Bracketing allows you to shoot in selected compensated EV values (maximum of  $\pm 2$  EV) shifting from the automatically set proper exposure (or selected exposure in Manual exposure mode) for three shots each time the shutter is released. For example, this is useful in selecting one shot out of several shots with bracketed exposures after processing the film, when the subject has pronounced contrast in shooting with color slide film and where the latitude of the proper exposure is minimal.



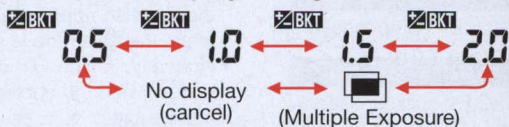



- 1 Rotate the Command Dial while pressing the Auto Exposure Bracketing  button to set desired bracketing value (within  $\pm 2$  EV without combining exposure compensation). The display changes as follows:



- When the bracketing value is set (and while the exposure meter is on), **BKT** appears and  blinks in the LCD panel, and  and electronic analog exposure display blink in the viewfinder. Bracketing value can be confirmed by pressing the  button.
- Shutter speed and aperture in Auto-Multi Program, aperture in Shutter-Priority Auto and shutter speed in Aperture-Priority Auto and Manual exposure mode are bracketed.
- In any of the exposure modes, Flash Exposure Bracketing and Auto Exposure Bracketing are simultaneously performed when a Speedlight is used.

## ■ Compensated EV value and bracketing order

Compensated EV value	Electronic analog exposure display	Bracketing order
0.5		0, -0.5, +0.5
1.0		0, -1.0, +1.0
1.5		0, -1.5, +1.5
2.0		0, -2.0, +2.0

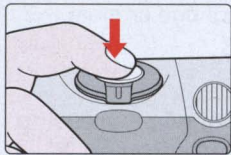

Electronic analog exposure display

First shot  
(correct EV)

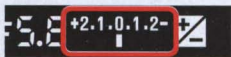

Second shot  
(under EV)

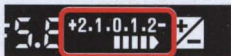

Third shot  
(over EV)

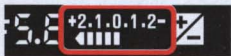

## 2 Compose picture, confirm focus indicator ● and shoot.

- Each time the shutter release button is depressed, correct EV, under EV, and over EV exposure are performed in that order while the blinking electronic analog exposure display shows the correct, under, then overexposure. Compensated shutter speed and aperture values are displayed during shooting.
- If the Exposure Compensation function (page 61) is also set, bracketing will be combined with the Exposure Compensation values. It is useful to perform Bracketing with a compensated value of over +2 EV or under -2 EV.
- If the end of the film roll is reached during bracketing, the remaining shots can be taken after new film has been loaded. Also, if you turn the power switch off during bracketing, the remaining shots can be taken after the power is turned back on.

## 3 Auto Exposure Bracketing is completed and automatically canceled when the third shot is taken.

- and in the LCD panel and and the electronic analog exposure display in the viewfinder disappear when the bracketing is completed.
- To cancel the bracketing, rotate the Command Dial while pressing the button so the display disappears from the LCD panel. Bracketing is not canceled by turning the power switch off.



### Check points

- Auto Exposure Bracketing cannot be performed in (AUTO mode) and Vari-Program.
- Auto Exposure Bracketing and Multiple Exposure (page 64) cannot be set simultaneously.
- Auto Exposure Bracketing and Long Time exposure (page 60) cannot be set simultaneously.

# Multiple Exposure

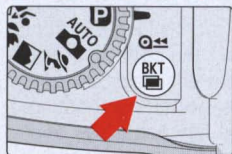
Multiple Exposure consists of two or more exposures of one or more subjects in the same frame.



- 1 Rotate the Command Dial while pressing the multiple exposure  button so  appears in the LCD panel. The display changes as follows:

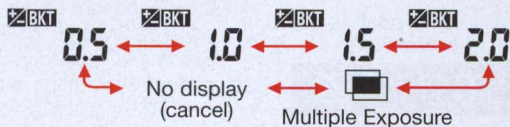

-  appears in the LCD panel when the Multiple Exposure is set.

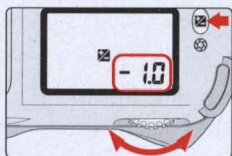
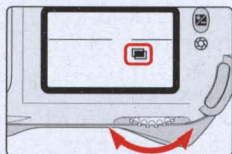

- 2 Rotate the Command Dial while pressing the  button to set the necessary Exposure Compensation.

- Test shooting is recommended since the compensation actually required varies depending on the shooting situation.
- When the background is completely dark and subjects do not overlap, no compensation is necessary for each shot.
- In some cases, frames may shift slightly in multiple exposure. In particular, film advance becomes unstable at the beginning and near the end of a film roll so multiple exposure is not recommended.

## Standard compensation value in multiple exposure





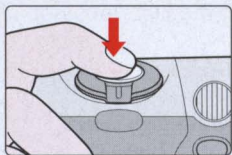

Number of exposures	Compensation value
Two	-1.0 EV
Three	-1.5 EV
Four	-2.0 EV
Eight or nine	-3.0 EV

Exposure Compensation is necessary depending on the number of exposures in multiple exposure since more than one image is exposed in the same frame.





### 3 Compose picture, confirm focus indicator ● and shoot.

- The first shot is taken and  and frame counter blink in the LCD panel when the shutter release button is fully depressed. The frame counter in the LCD panel does not count up and the film does not advance and multiple exposures can be taken from the second shutter release. The multiple exposure is canceled, film advances and  disappears from the LCD panel when the second shot is taken.
- To take more than two shots on the same frame, rotate the Command Dial while pressing the  button again after first shot is taken by depressing the shutter release button and while  is blinking so  appears without blinking. Repeat this operation as many times as you wish to continue taking pictures on the same frame.
- To cancel multiple exposure, rotate the Command Dial while pressing the  button so the display disappears from the LCD panel. Film is advanced and frame counter counts up when the multiple exposure is canceled before or during multiple exposure operation.

#### Check points

- Multiple Exposure cannot be performed in the  (AUTO mode) or Vari-Program.
- Multiple Exposure and Auto Exposure Bracketing (page 62) cannot be set simultaneously.

# Film Rewind

This section explains mid-roll rewind and what to do if the film does not rewind.

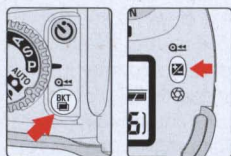

## Mid-roll rewind

- To rewind film at mid-roll, press the two film rewind buttons  $\mathcal{Q}$  simultaneously for approx. 1 sec.
- $\mathcal{Q}$ ,  $\mathcal{Q}$  and then  $\mathcal{E}$  appear in the LCD panel during film rewind and the frame counter counts backwards until rewind is complete.
- Film is completely rewound when a blinking  $\mathcal{E}$  shows in the frame counter. ( $\mathcal{E}$  appears without blinking when the exposure meter is off.) Make sure  $\mathcal{E}$  is blinking, open the camera back and remove the film cartridge.

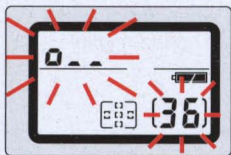
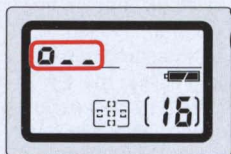

## If film does not start to rewind or film rewind stops at mid-roll

- When battery power is very low, or at low temperatures, film may not start rewinding or film rewind may stop at mid-roll, and  $\mathcal{Q}$ ,  $\mathcal{Q}$  and frame number will blink in the LCD panel. In this case, turn the power switch off, change batteries, then turn the power switch on and press the two film rewind buttons  $\mathcal{Q}$  simultaneously for approx. 1 sec. to rewind film again.

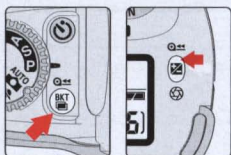

# Diopter Adjustment/Viewfinder Accessories

The N65/N65QD enables near- or far-sighted photographers to adjust the eyepiece diopter to suit their vision. Viewfinder accessories such as an eyepiece cap or eyepiece correction lens can also be attached.

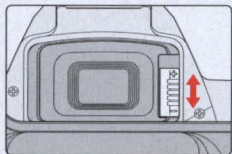
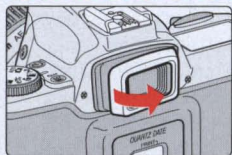

## Diopter adjustment

- Remove the rubber eyecup and slide the diopter adjustment lever while looking through the viewfinder until the focus brackets or other displays in the viewfinder appear sharp. Attach the rubber eyecup again after adjustment.
- The adjustable range of the finder diopter is  $-1.5\text{m}^{-1}$  to  $+0.8\text{m}^{-1}$ . Nine optional eyepiece correction lenses provide a viewfinder diopter range of  $-5$  to  $+3\text{m}^{-1}$  (page 94).

### NOTE: Using the diopter adjustment lever

Since the diopter adjustment lever is located next to the viewfinder, be careful not to poke yourself in the eye with your finger or fingernail while sliding the lever.

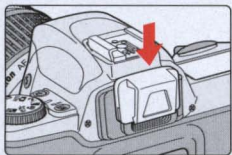
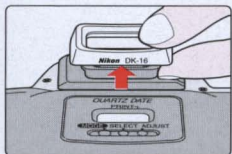



## Attaching viewfinder accessories

- To attach an eyepiece cap or eyepiece correction lens, remove the rubber eyecup and slide down the eyepiece cap or eyepiece correction lens.
- To reattach the rubber eyecup after removing eyepiece cap or eyepiece correction lens, make sure the "**Nikon DK-16**" stamp is at the bottom.

# Depth-of-Field Preview

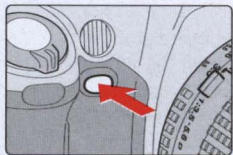
Electronic preview function is available with this camera. Depress the depth-of-field preview button to confirm the depth of field through the viewfinder (see page 74).







- Pressing the depth-of-field button stops the lens down to the aperture controlled in  (AUTO mode), Vari-Program, Auto-Multi Program or Shutter-Priority Auto exposure mode, and down to the aperture selected in Aperture-Priority Auto or Manual exposure mode. By looking through the viewfinder, the approximate depth of field with the given aperture can be confirmed.

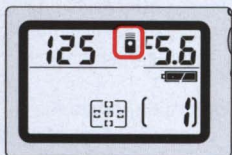
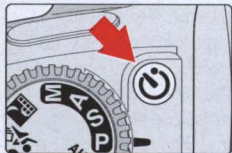



# Remote Control Operation (optional)

Use the optional remote control to release the camera's shutter from a distance. As with self-timer operation, the remote control can also be used when you want to be in the photograph. You can also use the remote control instead of a cable release to reduce camera shake.



- 1** Press the  remote control button a number of times so  (immediate release) or  (two-sec. delay release) appears in the LCD panel. (Or, rotate the Command Dial while pressing the  remote control button.) The display changes as follows:



- You can choose to release the shutter either immediately after () or two sec. after () the shutter release button on the remote control unit is pressed.
- Once remote control operation is set, the camera remains ready to receive a signal from the remote control unit for 60 sec. If no signal is sent for 60 sec., the remote control mode is canceled and  or  disappears from the LCD panel.
- The remote control cannot be operated unless the camera's shutter can be released (i.e. when subject is not in focus with autofocus).
- After the shutter is released, the camera remains ready to receive another signal from the remote control unit for 60 sec.



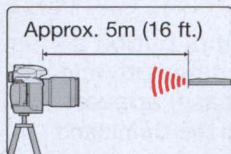
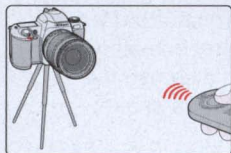

## NOTE: Before using remote control

When using the remote control for the first time, make sure to pull out the insulation sheet placed on the battery inside the remote control unit that is set when purchased.

# Remote Control Operation (optional)—continued



## 2 Point the remote control unit toward the camera and press the shutter release button.

- When immediate release is selected, the self-timer lamp lights after shutter release (except when the Speedlight is used). When Red-Eye Reduction (page 79) is also set, the self-timer lamp lights at the same output level as the normal Red-Eye Reduction before the shutter releases and the flash fires when the shutter is released.
- The shutter is released after the self-timer lamp lights for approx. 2 sec. in two sec. delay mode. When Red-Eye Reduction (page 79) is also set, the self-timer lamp lights at the same output level as the normal Red-Eye Reduction after the self-timer lamp lights for approx. 2 sec. and the flash fires when the shutter is released.
- To cancel the remote control operation, press the  button again or rotate the Command Dial while pressing the  button so  or  disappears from the LCD panel. Or, turn the power switch off.

### Focusing in remote control operation

Two methods to shoot with autofocus with remote control:

1. Autofocus activated by signal from remote control:  
Shutter is released when (or two sec. after) the subject is in focus. However, when focus cannot be achieved, it remains in standby mode.
2. Autofocus activated by lightly pressing shutter release button on the camera body before remote control operation:  
Lightly press the shutter release button on the camera body while the remote control is standing by to achieve focus. Once focus is achieved, focus is locked (even though the finger is removed from the shutter release button). Shutter is released when (or two sec. after) the shutter release signal is received from the remote control unit.

### Check points

- Use a tripod or place the camera on a stable surface before using the remote control.
- When you are taking pictures but not looking through the viewfinder, cover the eyepiece with the supplied eyepiece cap DK-5 (page 3) or with your hand before pressing the shutter release button to prevent interference from stray light and achieve correct exposure.
- The shooting distance for remote control operation is within 5m (16 ft.) directly in front of the camera. To shoot beyond the shooting distance of the remote control, use the self-timer (page 40). Remote control operation cannot be performed when the camera has extreme backlighting. Change the camera position in this case.
- If the shutter cannot be released with the remote control, change the battery inside the remote control unit (page 72). (The life of the battery inside the remote control unit is approx. 5 years.)
- Use one 3V CR2025 lithium battery in the remote control unit.

### Long Time (Time) exposure with remote control

When the camera is set to Long Time (Time) exposure (page 60), pressing the remote control's shutter release button opens the camera's shutter and pressing the shutter release button again closes the shutter. This function is useful for shooting nighttime scenes or stars. (Use of a tripod is recommended.) Self-timer lamp flickers slightly once every 2 sec. during Time exposure.

# Remote Control Operation (optional)—continued

## ■ Changing battery inside the remote control unit

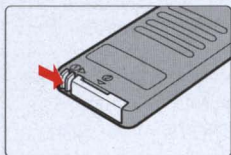

**1** While keeping the battery holder release lever pressed as the arrow on the remote control unit indicates to release the lock, pull out the battery holder from the remote control unit.

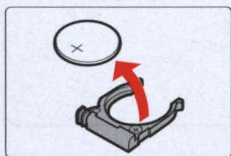
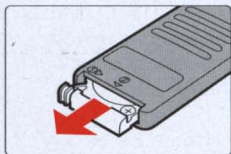

**2** Remove the used battery.

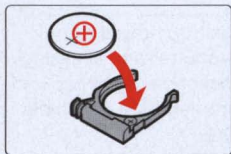

**3** Insert a new CR2025 3V lithium battery with ⊕ side facing up.

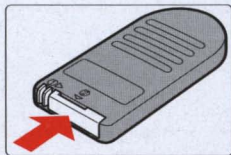

**4** Insert the battery holder until it clicks shut.

### **NOTE: Storing batteries**

Keep batteries out of children's reach. If swallowed, contact a doctor immediately. (For "Notes on Batteries", see page 98.)



# Available Mode Combinations

The following chart lists available modes when a CPU Nikkor lens such as D- or G-type lens is attached.

Exposure mode	AF-Assist Illuminator	Flexible Program	Exposure compensation	Auto Exposure Bracketing	Multiple exposure
AUTO	○	—	—	—	—
	○	—	○	—	—
	—	—	○	—	—
	○	—	○	—	—
	—	—	○	—	—
	○	—	○	—	—
<b>P</b>	○	○	○	○	○
<b>S</b>	○	—	○	○	○
<b>A</b>	○	—	○	○	○
<b>M</b>	○	—	—	○	○

Exposure mode	Metering system	Film advance mode	Focus mode		
			AF		MF
			①	②	③
AUTO	Matrix	Single frame	⊙	○	○
	Matrix	Single frame	⊙	○	○
	Matrix	Single frame	⊙	○	○
	Matrix	Single frame	○	⊙ (Center)	○
	Matrix	Continuous*	⊙	○	○
	Matrix	Single frame	⊙	○	○
<b>P</b>	Matrix	Single frame	⊙	○	○
<b>S</b>	Matrix	Single frame	⊙	○	○
<b>A</b>	Matrix	Single frame	⊙	○	○
<b>M</b>	Center-Weighted	Single frame	⊙	○	○

①: Dynamic AF Mode with Closest-Subject Priority

②: Dynamic AF Mode

③: Single Area Mode

○: Available

⊙: Automatically set when the exposure mode is selected. (Other mode also selectable.)

—: Unavailable

\* Single frame with use of built-in Speedlight.

## About Depth of Field

Basics of the relationship between focus and depth of field are explained in this section.

### ■ Depth of field

When focusing, depth of field should be considered. Depth of field is the zone of sharpest focus in front of and behind the subject on which the lens is focused. It varies according to shooting distance, focal length and, above all, aperture. Smaller apertures (larger f-numbers) will produce a deeper depth of field where the background and foreground become sharper; larger apertures (smaller f-numbers) will produce a shallower depth of field where the background becomes blurred. Similarly, shorter shooting distance or longer focal length will produce a shallower depth of field, and longer shooting distance or shorter focal length will produce a deeper depth of field. Note that depth of field tends to be shallower in front of and deeper behind the subject in focus.



Small aperture  $f/22$

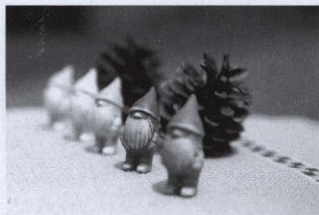

Large aperture  $f/2.8$





# FLASH PHOTOGRAPHY







This section introduces various aspects of flash photography using the built-in Speedlight.

- Matrix Balanced Fill-Flash, Standard TTL Flash
- Ready-light, accessory shoe
- Flash sync mode
- Built-in Speedlight
- Flash shooting distance range
- Usable lenses with built-in Speedlight

# Built-In Speedlight and TTL Flash Modes

## ■ Built-in Speedlight and TTL Flash modes

This camera is equipped with a built-in Speedlight that provides an angle of coverage for a 28mm lens with a guide number of 12 (ISO 100, m) or 40 (ISO 100, ft.). When the subject is dark or backlit (except in  or ) in  (AUTO mode) or Vari-Program, the built-in Speedlight automatically pops up. When the shutter is released, the flash fires to create natural-looking flash photography utilizing **Matrix Balanced Fill-Flash**.

In **P** (Auto-Multi Program), **S** (Shutter-Priority Auto), **A** (Aperture-Priority Auto) or **M** (Manual) exposure mode, when the subject is dark or backlit, flash recommended indication  blinks in the viewfinder, and the Speedlight pops up when the Speedlight lock-release button is pressed and the **Matrix Balanced Fill-Flash** is possible. (In Manual exposure mode, **Standard TTL Flash** is selected.) In addition to shooting in dim light, the flash can be used in daylight to reduce shadows on the main subject or to put catchlights in your subject's eyes.

Five flash sync modes—**Front-Curtain Sync** (Normal Sync), **Slow Sync**, **Rear-Curtain Sync**, **Red-Eye Reduction** and **Red-Eye Reduction with Slow Sync**—are available with this camera.

- See below for the TTL Flash modes, page 80 for using the built-in Speedlight and page 78 for the flash sync modes.



### Matrix Balanced Fill-Flash

Matrix Balanced Fill-Flash is automatically set in , Vari-Program, **P**, **S** or **A** exposure mode. In this flash mode, a well-balanced exposure of the main subject (subject in focus) and the background is achieved—based on the brightness sensed by the Matrix Metering.

### Standard TTL Flash

Standard TTL Flash is automatically selected when the exposure mode is set to **M**. In Standard TTL Flash, the main subject is correctly exposed but background exposure is not considered. Standard TTL Flash is useful when you want to highlight the main subject.

# Ready-Light/Accessory Shoe

## Ready-light

●  90 F5.6



- When using the built-in Speedlight or an optional Speedlight such as the SB-28/28DX, SB-27, SB-23 or SB-22s, the ready-light  appears in the viewfinder when the Speedlight is fully charged and ready to fire.
- If the ready-light blinks approx. 3 sec. after full flash output, underexposure may have occurred (when using built-in Speedlight or optional Speedlight set to TTL or non-TTL Auto Flash mode). Check the focus distance, aperture or flash shooting distance range and shoot again.

## Accessory shoe

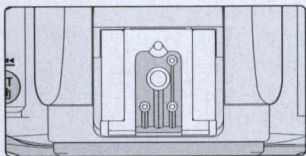

- An optional Speedlight, i.e. SB-28/28DX, SB-27, SB-23 or SB-22s can be attached directly to the accessory shoe of the N65/N65QD without a cord. This accessory shoe is equipped with a safety lock which prevents accidental drop when a Speedlight with a safety-lock pin (SB-28/28DX, SB-27, SB-26, SB-25 or SB-22s) is attached.



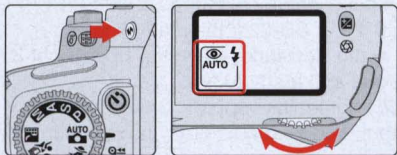

# Flash Sync Mode Features

Five flash sync modes are available with the N65/N65QD.





Set the flash sync mode by rotating the Command Dial while pressing the flash sync mode button .

## : Front-Curtain Sync (Normal Sync)

Set the flash sync mode to Front-Curtain Sync for normal flash photography. The camera's shutter speed is automatically set between 1/90 to 1/60 sec. for flash photography in  (AUTO mode) or , 1/90 to 1/15 sec. in , and to 1/90 sec. in Auto-Multi Program, Aperture-Priority Auto,  (Close-Up mode) or  (Sports Continuous mode). (With optional Speedlight SB-26, SB-25 and SB-24, set the Speedlight's sync mode selector to NORMAL.)



## : Slow Sync

Slow Sync can be used in  Night Scene mode, Auto-Multi Program or Aperture-Priority Auto exposure mode. Normally, the camera's shutter speed is automatically set to 1/90 sec. for flash photography. However, for shooting nighttime scenes, Slow Sync uses a slower shutter speed (down to maximum of 30 sec., 1 sec. in  Night Scene mode) to bring out background details using all of the available light.



## : Rear-Curtain Sync



Rear-Curtain Sync can be used in Auto-Multi Program, Shutter-Priority Auto, Aperture-Priority Auto or Manual exposure mode. Normally, the Speedlight fires at the end of the exposure, turning available light into a stream of light that follows the flash-illuminated moving subject. When Rear-Curtain Sync is set in Auto-Multi Program or Aperture-Priority Auto exposure mode, Slow Sync is automatically set. (With an optional Speedlight SB-26, 25 and 24, set the Speedlight's sync mode selector to REAR.)





## : Red-Eye Reduction

The Red-Eye Reduction lamp lights for approx. 1 sec. before the flash fires in order to reduce the red-eye effect in photos of people or animals. Red-Eye Reduction can

be used in  AUTO mode, Vari-Program (except for  Night Scene), Auto-Multi Program, Shutter-Priority Auto, Aperture-Priority Auto or Manual exposure mode. (With optional Speedlight SB-28/28DX, SB-27 and SB-26, the Red-Eye Reduction lamp of the Speedlight lights.)



## : Red-Eye Reduction with Slow Sync

Red-Eye Reduction with Slow Sync can be used in  Night Scene mode, Auto-Multi Program or Aperture-Priority Auto exposure mode. Red-Eye Reduction and Slow Sync mode are simultaneously set. (With optional Speedlight SB-28/28DX, SB-27 and SB-26, the Red-Eye Reduction lamp of the Speedlight lights.)



## : Flash Cancel

Flash Cancel can only be selected in  (AUTO mode) or Vari-Program. Set Flash Cancel when you want to cancel the flash and have the photograph exposed only with the natural light. Flash Cancel cannot be set when the built-in Speedlight is in the up position. Set the Flash Cancel before lightly pressing the shutter release button. (The built-in Speedlight is canceled but when optional Speedlights are attached, flash is not canceled.)

To cancel Flash Cancel, turn the power switch off or select another exposure mode.

### NOTE: Flash Sync Modes

- In Front-Curtain Sync, shutter speed shifts automatically to 1/90 sec. when the shutter speed is set to faster than 1/90 sec. in Shutter-Priority Auto or Manual exposure mode.
- When Red-Eye Reduction or Red-Eye Reduction with Slow Sync is selected, the Red-Eye Reduction lamp lights for approx. 1 sec. before the flash fires. Do not move the camera or let the subject move until the shutter is released. (Red-Eye Reduction is not recommended in shooting situations where shutter release is your top priority.)
- With some lenses, light from the Red-Eye Reduction lamp may not reach the subject's eyes. In some cases, the red-eye effect may not be sufficiently reduced due to the location of subject.
- With Slow Sync and Red-Eye Reduction with Slow Sync, keep the camera steady to prevent picture blur since the shutter speed is slow. Use of a tripod is recommended.

# Using Built-In Speedlight

This section explains how to use the built-in Speedlight set to desired flash sync mode when a D- or G-type AF Nikkor lens is attached.

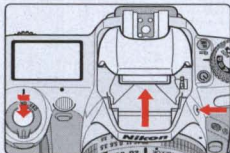



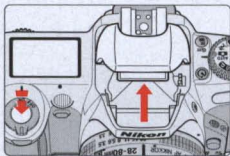

In **P, S, A** or **M** exposure mode

**1** In Auto-Multi Program, Shutter-Priority Auto, Aperture-Priority Auto or Manual exposure mode, release the built-in Speedlight by pressing the  flash lock-release button.



In **AUTO** or Vari-Program

- When the subject is dark or backlit and shutter release button is lightly pressed, the flash recommended indication  blinks in the viewfinder in Auto-Multi Program, Shutter-Priority Auto, Aperture-Priority Auto or Manual exposure mode.
- In **AUTO** (AUTO mode) or Vari-Program, when the subject is dark or backlit (except in  or ) and the shutter release button is lightly pressed, **AUTO**  appears in the LCD panel and the built-in Speedlight automatically pops up.
- When the Speedlight is ready to fire,  appears without blinking in the viewfinder (when the camera's meter is on).
- Press the Speedlight down gently until it clicks into place to retract it.

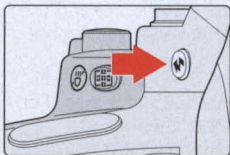



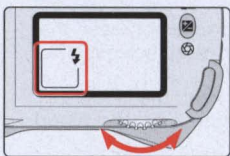

**2** Set the flash sync mode by rotating the Command Dial while pressing the  flash sync button.





- **Matrix Balanced Fill-Flash** is selected in exposure modes other than Manual, and **Standard TTL Flash** is selected for Manual exposure mode. See page 76 for details.
- See the table on pages 83 and 86 for shutter speed and aperture, available sync mode in each exposure mode.





- In Auto-Multi Program, Shutter-Priority Auto, Aperture-Priority Auto or Manual exposure mode, selected flash sync mode remains once it is set. To change the flash sync mode, rotate the Command Dial while pressing the  button to select another flash sync mode.
- In  (AUTO mode) or Vari-Program, turning the power switch off or selecting another exposure mode cancels the selected flash sync mode and returns to its initial setting (table on page 86).
- In  (AUTO mode) or Auto-Multi Program exposure mode, the camera automatically controls maximum available aperture according to the film speed. See page 93.
- Continuous shooting cannot be used in flash shooting even when  (Sports Continuous mode) is selected.

Rotating the Command Dial while pressing the  button changes the display as follows.

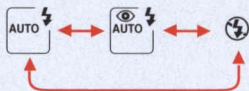
In  or Vari-Program (except ):



\*  does not appear when the built-in Speedlight is up.



In  (Night Scene mode):

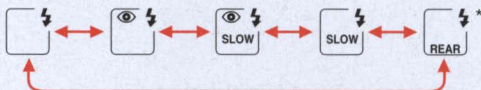

\*  does not appear when the built-in Speedlight is up.

In Auto-Multi Program or Aperture-Priority Auto exposure mode:





\*  is displayed when you release your finger from the  button.

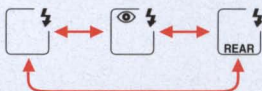

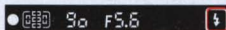



In Shutter-Priority Auto or Manual exposure mode:





**3** Confirm  appears in the viewfinder, make sure the subject is within the flash shooting distance range and shoot.

- The shutter cannot be released unless  appears without blinking in the viewfinder.
-  in the viewfinder blinks approx. 3 sec. after full flash output. This may indicate underexposure has occurred. Check the focus distance, aperture or flash shooting distance range and shoot again.
- When the subject is dark, the AF-Assist Illuminator automatically turns on to guide autofocus. See page 48 for details.
- With VR Nikkor lenses, the vibration reduction function when shutter release button is lightly pressed does not operate while the flash is charging.

Exposure mode	Available shutter speed	Available aperture	Page
	Automatically set to 1/90-1/60 sec.	Automatically set	51
			37
	Automatically set to 1/90-1/15 sec.		37
	Automatically set to 1/90 sec.		37
			38
	Automatically set to 1/90-1 sec.		38
<b>P</b>	Automatically set to 1/90 sec.*1		52
<b>S</b>	1/90-30 sec.*2		54
<b>A</b>	Automatically set to 1/90 sec.*1	Desired setting*3	56
<b>M</b>	1/90-30 sec.*2, -- (Time)		58

\*1 Shutter speed is prolonged up to 30 sec. with Slow Sync, Rear-Curtain Sync and Red-Eye Reduction with Slow Sync.

\*2 Shutter speed shifts automatically to 1/90 sec. when the shutter speed is set to faster than 1/90 sec. and the built-in Speedlight pops up (or attached optional Speedlight is turned on). In this case, 90 appears in the viewfinder and the selected shutter speed display blinks in the LCD panel.

\*3 Flash shooting distance range depends on the ISO speed of the film in use and aperture setting. In Aperture-Priority Auto or Manual exposure mode, set the aperture according to the flash shooting distance range table on page 84.

# Flash Shooting Distance Range

Flash shooting distance for the built-in Speedlight changes according to the film speed in use and aperture setting.

ISO film speed	25	50	100	200	400	800	Flash shooting distance range m/ft.
Guide number m/ft.	6/20	8.5/28	12/40	17/56	24/79	34/112	
Aperture value	—	—	1.4	2	2.8	4	2-8.5/6.6-28
	—	1.4	2	2.8	4	5.6	1.4-6/4.6-20
	1.4	2	2.8	4	5.6	8	1-4.2/3.3-14
	2	2.8	4	5.6	8	11	0.7-3/2.3-10
	2.8	4	5.6	8	11	16	0.6-2.1/2.0-6.9
	4	5.6	8	11	16	22	0.6-1.5/2.0-4.9
	5.6	8	11	16	22	32	0.6-1.1/2.0-3.6
8	11	16	22	32	—	0.6-0.8/2.0-2.6	

- The maximum flash shooting distance can also be calculated by dividing the guide number by the selected aperture value.

Example: When f/2.8 is selected with ISO 100 film using the camera's built-in Speedlight, the maximum flash shooting distance will be:

$12/2.8 = \text{approx. } 4.2\text{m}$  or  $40/2.8 = \text{approx. } 14\text{ ft.}$

# Usable Lenses with Built-In Speedlight

28mm to 200mm non-zoom CPU Nikkor lenses, AF 300mm f/4 ED and AF-S 300mm f/4 ED lenses can be used with the built-in Speedlight. AF-S 17-35mm f/2.8 ED, AF 18-35mm f/3.5-4.5 ED, AF 20-35mm f/2.8 zoom lenses cannot be used with the built-in Speedlight. Other zoom lenses can be used; however, refer to the table below for the zoom lenses with some limitations in usable focal length or shooting distance.







## NOTE: Using built-in Speedlight







- Make sure to remove the lens hood.
- The built-in Speedlight cannot be used with zoom lenses set to Macro in wideangle.
- Vignetting occurs at the edges of the frame resulting in underexposure with the following zoom lenses, which have limitations in usable focal length or shooting distance.

Lens	Limitations
AF 24-50mm f/3.3-4.5	35mm or longer focal length
AF 24-85mm f/2.8-4	50mm or longer focal length; and at 50mm, 1m (3.3 ft.) or longer shooting distance; at 70-85mm, 0.7m (2.3 ft.) or longer shooting distance
AF 24-120mm f/3.5-5.6	35mm or longer focal length; and at 35mm, at 3m (9.8 ft.) or longer shooting distance; at 50mm, 1m (3.3 ft.) or longer shooting distance; at 70mm, 0.7m (2.3 ft.) or longer shooting distance
AF-S 28-70mm f/2.8 ED	70mm focal length and at 1.5m (4.9 ft.) or longer shooting distance
AF 28-70mm f/3.5-4.5	At 28mm, at 1m (3.3 ft.) or longer shooting distance
AF 28-80mm f/3.5-5.6	At 28mm, at 1.8m (5.9 ft.) or longer shooting distance
AF 28-85mm f/3.5-4.5	35mm or longer focal length; and at 35mm, at 2m (6.6 ft.) or longer shooting distance
AF 28-105mm f/3.5-4.5	At 28mm, at 1.8m (5.9 ft.) or longer shooting distance
AF 28-200mm f/3.5-5.6	50mm or longer focal length
AF 35-70mm f/2.8	50mm or longer focal length
AF Micro 70-180mm f/4.5-5.6 ED	At 70mm, at 1.7m (5.6 ft.) or longer shooting distance; at 85mm, 1.3m (4.3 ft.) or longer shooting distance; at 105-135mm, at 0.8m (2.6 ft.) or longer shooting distance
AF 80-200mm f/2.8 ED	At 80mm, 3m (9.8 ft.) or longer shooting distance
AF-S 80-200mm f/2.8 ED	105mm or longer focal length

# Available Flash Sync Mode Combinations

The following chart lists available flash sync modes when a CPU Nikkor lens such as D- or G-type lens is attached.

Exposure mode	TTL Auto Flash	Front-Curtain Sync	Red-Eye Reduction	Red-Eye Reduction with Slow Sync
	①	⊙	○	—
	①	⊙	○	—
	①	⊙	○	—
	①	⊙	○	—
	①	⊙	○	—
	①	—	—	○
<b>P</b>	①	○	○	○
<b>S</b>	①	○	○	—
<b>A</b>	①	○	○	○
<b>M</b>	②	○	○	—

Exposure mode	Slow Sync	Rear-Curtain Sync	Flash Cancel
	—	—	○*
	—	—	○*
	—	—	○*
	—	—	○*
	—	—	○*
	⊙	—	○*
<b>P</b>	○	○	—
<b>S</b>	—	○	—
<b>A</b>	○	○	—
<b>M</b>	—	○	—

①: Matrix Balanced Fill-Flash

②: Standard TTL flash

○: Available

⊙: Automatically set when the exposure mode is selected. (Other flash sync mode also selectable.)

—: Unavailable

\* Selectable when built-in Speedlight is retracted.



# MISCELLANEOUS



This section explains miscellaneous information.

- Lens compatibility
  - Usable optional Speedlights
  - Optional accessories
  - Camera care
  - Notes on batteries
  - Troubleshooting
  - Glossary
  - Specifications
  - Index
- 

# Lens Compatibility

Use a CPU Nikkor lens (except IX-Nikkor) with this camera. D- or G-type AF lenses give you access to all available functions.

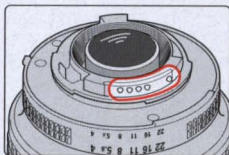

CPU contacts of CPU  
Nikkor lens

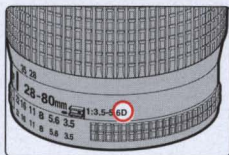

D-type Nikkor lens

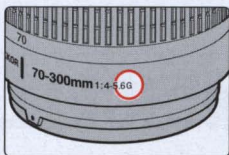

G-type Nikkor lens

## G-type Nikkor and other CPU Nikkor lens

- The G-type Nikkor lens has no aperture ring; aperture should be selected from camera body. Unlike other CPU Nikkor lenses, aperture does not need to be set to minimum (largest f-number) (page 18).
- CPU Nikkor lenses other than G-type Nikkor lens have an aperture ring. Set the lens aperture to its minimum and lock. When the lens is not set to its minimum aperture setting and the power switch is turned on, **FE** blinks in the LCD panel and viewfinder and the shutter cannot be released (page 18).



## Types of CPU lenses and other usable lenses/accessories

Lens/accessories		Focus mode			Exposure mode		Metering system		
		Autofocus	Manual with electronic rangefinder	Manual	Any mode other than M	M	Matrix		Center-Weighted*1
							3D 6-segment	6-segment	
CPU Nikkor*2	D-type AF Nikkor*3, G-type AF Nikkor, AF-S, AF-I Nikkor	○	○	○	○	○	—	○	
	PC Micro-Nikkor 85mm f/2.8D*4	—	○*5	○	—	○	—	○	
	AF-I Teleconverter*6	○*7	○*7	○	○	○	—	○	
	Non-D or G-type AF Nikkor (except AF Nikkor for F3AF)	○	○	○	○	○	—	○	
	AI-P Nikkor	—	○*8	○	○	○	—	○	
Non-CPU Nikkor*9	AI-S or AI type Nikkor, Series-E, AI-modified Nikkor	—	○*8	○	—	○*10	—	—	
	Medical-Nikkor 120mm f/4	—	○	○	—	○*11	—	—	
	Reflex-Nikkor	—	—	○	—	○*10	—	—	
	PC-Nikkor	—	○*5	○	—	○*10	—	—	
	AI-S or AI type Teleconverters	—	○*7	○	—	○*10	—	—	
	Bellows Focusing Attachment PB-6*12	—	○*7	○	—	○*10	—	—	
Auto Extension Rings (PK-11A, PK-12, PK-13 and PN-11)	—	○*7	○	—	○*10	—	—		

\*1 Metering system automatically switches to Center-Weighted Metering when the exposure mode is set to Manual.

\*2 IX-Nikkor lenses cannot be attached.

\*3 This camera is compatible with the Vibration Reduction function of the VR Nikkor lens.

\*4 The camera's exposure metering and flash control system do not work properly when shifting and/or tilting the lens, or when using an aperture other than the maximum aperture.

\*5 Without shifting and/or tilting the lens.

\*6 Compatible with AF-S and AF-I Nikkor except AF-S 17-35mm f/2.8D IF-ED and AF-S 28-70mm f/2.8D IF-ED.

\*7 With maximum effective aperture of f/5.6 or faster.

\*8 With maximum aperture of f/5.6 or faster.

\*9 Some lenses/accessories cannot be attached. (See page 90.)

\*10 With exposure mode set to Manual. The exposure meter cannot be used.

\*11 With exposure mode set to Manual and shutter speed set to 1/90 sec. or slower, the exposure meter cannot be used.

\*12 Attach the PB-6 vertically. (PB-6 can be set to horizontal position after attaching.)

- AS-15 must be attached in combination with Medical-Nikkor 200mm f/5.6 for the lens to fire the flash.
- Reprocopy Outfit PF-4 can be attached in combination with Camera Holder PA-4.

# Lens Compatibility—continued

## When a non-CPU lens is attached

Set exposure mode to Manual with a non-CPU lens. (When other modes are selected, shutter cannot be released.) The camera's exposure meter cannot be used and the aperture cannot be set using the Command Dial when using non-CPU lenses. F - - appears in place of the aperture indication in the LCD panel and viewfinder; set/confirm aperture using the lens aperture ring.

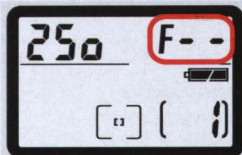

## CAUTION: Nikkor lenses/accessories that cannot be attached to the N65/N65QD

The following Nikkor lenses/accessories cannot be attached to the N65/N65QD (otherwise camera body or lens may be damaged):

- TC-16A Teleconverter
- Non-AI lenses
- 400mm f/4.5, 600mm f/5.6, 800mm f/8 and 1200mm f/11 with Focusing Unit AU-1
- Fisheye 6mm f/5.6, 7.5mm f/5.6, 8mm f/8 and OP 10mm f/5.6
- Old type 21mm f/4
- K1, K2 Ring, Auto Extension Ring PK-1, PK-11, Auto Ring BR-2, BR-4
- ED 180-600mm f/8 (No. 174041-174180)
- ED 360-1200mm f/11 (No. 174031-174127)
- 200-600mm f/9.5 (No. 280001-300490)
- 80mm f/2.8, 200mm f/3.5 and TC-16 Teleconverter for F3AF
- PC 28mm f/4 (No. 180900 or smaller)
- PC 35mm f/2.8 (No. 851001-906200)
- Old type PC 35mm f/3.5
- Old type Reflex 1000mm f/6.3
- Reflex 1000mm f/11 (No. 142361-143000)
- Reflex 2000mm f/11 (No. 200111-200310)

# Usable Optional Speedlights

Usable optional Speedlights and available flash modes are listed in the following table. Available modes are listed assuming a CPU lens is attached.

Flash mode Speedlight	Matrix Balanced Fill-Flash*1	Non-TTL Auto flash	Manual	Repeating Flash	Rear- Curtain Sync	Red-Eye Reduction
SB-28, SB-28DX	○	○	○	○	○	○
SB-27	○	○	○	—	○	○
SB-26*2	○	○	○	○	○	○
SB-25, SB-24	○	○	○	○	○	○
SB-23, SB-29*3, SB-21B*3	○	—	○	—	○	○
SB-22s, SB-22, SB-20, SB-16B, SB-15	○	○	○	—	○	○
SB-11*4, SB-14*4, SB-140*4	○	○	○	—	○	○

\*1 Selecting Manual exposure mode automatically changes the Matrix Balanced Fill-Flash mode to Standard TTL Flash (page 76).

\*2 Wireless Slave Flash can be performed. Shutter speed is automatically controlled to 1/60 sec. (or 1/60 sec. or slower in S or M exposure mode) with the Wireless Slave Flash selector set to D and camera's flash sync mode set to Front-Curtain Sync or Red-Eye Reduction.

\*3 With the SB-29 and SB-21B, autofocus can only be used when an AF Micro-Nikkor (60mm, 105mm, 200mm and 70-180mm) is attached.

\*4 TTL Auto Flash is possible with TTL Remote Cord SC-23.

In A or M flash mode, attach SU-2 to SC-13 with SB-11 and SB-14, or attach SU-3 to SC-13, SC-11 or SC-15 to AS-15 with SB-140.





Ultraviolet photography can be performed only when SB-140 is set to M. (Infrared photography cannot be performed.)

## NOTE: Flash attachments made by manufacturers other than Nikon

Use only Nikon Speedlights. Other units may damage the camera's electrical circuit due to incompatible voltage requirements (not compatible with 250V or higher), electric contact alignment or switch phase. When flash attachments made by manufacturers other than Nikon are attached, the built-in Speedlight may not pop up all the way (with power switch of the Speedlight on or off). When the built-in Speedlight is automatically fired in  AUTO mode or Vari-Program, vignetting or uneven illumination may result.

# Usable Optional Speedlights—continued

## ■ Notes on using optional Speedlights

- See your Speedlight manual for details. If the camera groups are defined in the manual of the Speedlight with TTL Auto Flash, see the section for camera **group II**.
- Flash sync speed is 1/90 sec. or slower when using an optional Speedlight.
- Available film speeds for TTL Auto Flash are ISO 25 to ISO 800.
- When Red-Eye Reduction or Red-Eye Reduction with Slow Sync is set on a camera attached with the SB-28/28DX, 27 or 26, the Red-Eye Reduction lamp of the Speedlight lights up. With other Speedlights, the Red-Eye Reduction lamp of the camera body lights up.
- When optional Speedlight with AF-Assist Illuminator, SB-28/28DX, 27, 26, 25 or 24, is attached, the AF-Assist Illuminator of the optional Speedlight emits light when the focus mode is set to AF, an AF Nikkor lens is attached, the subject is dark and center focus area is selected or Dynamic AF Mode with Closest-Subject Priority is activated. With other optional Speedlights, the AF-Assist Illuminator on the camera emits light.
- Set the exposure mode to Aperture-Priority Auto or Manual to take flash pictures with non-TTL flash mode.
- With the SB-26, 25 or 24, even if Front-Curtain Sync is set on the camera body, the Speedlight performs Rear-Curtain Sync when Rear-Curtain Sync is set on the Speedlight in **P**, **S**, **A** or **M** exposure mode (camera setting is overridden). In  or Vari-Program (except ) , Speedlight performs Front-Curtain Sync even if Rear-Curtain Sync is set on Speedlight (Speedlight setting is overridden).
- With the SB-26, 25 or 24, when Slow Sync is set on the camera body in , Rear-Curtain Sync is performed if Rear-Curtain Sync is set on the Speedlight.
- With the SB-26, 25 or 24, when Red-Eye Reduction or Red-Eye Reduction with Slow Sync is set on the camera body, Speedlight performs Red-Eye Reduction or Red-Eye Reduction with Slow Sync even if Rear-Curtain Sync is set on the Speedlight.
- **FE** in the LCD panel and **FE** and  in the viewfinder blink and the shutter cannot be released when the exposure mode is set to **P**,  or Vari-Program and the attached optional Speedlight is not set to TTL Auto Flash. Set the Speedlight flash mode to TTL, or set the camera's exposure mode to **S**, **A** or **M**.

- With SK-6 and SB-24 attached, the AF-Assist Illuminators of the camera body and the Speedlight do not emit light.
- In **P** or  exposure mode, the camera automatically controls the maximum available aperture as follows in relation to the film speed:

ISO film speed		25	50	100	200	400	800
Maximum available aperture	Built-in Speedlight	2	2.4	2.8	3.3	4	4.8
	Optional Speedlight	2.8	3.3	4	4.8	5.6	6.7

\* When film speed increases by one step, the maximum available aperture is stopped down by 1/2 f/stop. If you are using a lens with a maximum aperture smaller than that listed above, the automatically controlled aperture range is from the lens' maximum to minimum aperture.

- Use the optional Accessory Shoe Adaptor AS-15 to use the sync terminal.

**NOTE: When optional Speedlight is attached**

Turn on the optional Speedlight power switch or set the built-in Speedlight to Flash Cancel mode so the built-in Speedlight won't pop up automatically when an optional Speedlight is attached. When the built-in Speedlight automatically pops up in  AUTO mode or Vari-Program, vignetting or uneven illumination may result since the Speedlight may not pop up all the way.

# Optional Accessories

A variety of optional accessories, including power source and Speedlight is available for the N65/N65QD.

## Battery Pack MB-17

- With Battery Pack MB-17, four 1.5V AA-type alkaline-manganese, lithium, NiCd or Ni-MH batteries can be used to power the N65/N65QD. When AA-type lithium batteries are used, the usable number of film rolls increases and stable performance is maintained at low temperatures. (Film advance speed in  Sports Continuous mode remains the same [as that of batteries installed only in the camera body] with the MB-17.)

## Remote Control Unit ML-L3

- Remote control releases the camera's shutter from a distance. As with self-timer operation, the remote control can also be used when you want to be in the photograph. You can also use the remote control instead of a cable release to reduce camera shake.

## Eyepiece correction lenses

- Eyepiece correction lenses enable near- or far-sighted photographers to adjust the eyepiece diopter to suit their vision, and can be attached easily by inserting onto the viewfinder eyepiece. Nine optional eyepiece correction lenses provide viewfinder diopter settings of -5, -4, -3, -2, 0, +0.5, +1, +2 and +3m<sup>-1</sup> (combined diopter with setting on camera body). We recommend that you actually look through the viewfinder with various correction lenses attached before making a purchase, since viewfinder diopter differs from one person to another. Use the optional eyepiece correction lens when you need eyepiece correction over -1.5 to +0.8m<sup>-1</sup> that can be adjusted using the N65/N65QD's diopter adjustment lever.

## Lenses

- A wide variety of AF lenses — 14mm to 600mm wideangle, telephoto, zoom, Micro or DC (Defocus image Control) — is available for the N65/N65QD.

## Filters

- Nikon filters can be divided into three types: screw-in, drop-in and rear-interchange. With the N65/N65QD, the filter factor need not be considered except for the R60 filter. Compensate exposure +1 EV when using the R60. Note that when special filters available from manufacturers other than Nikon are used, autofocus or the electronic rangefinder may not operate properly.

- Use circular-polarizing filter C-PL instead of polarizing filter Polar. The linear polarizing filter cannot be used with the N65/N65QD.
- Use NC filter when using the filter to protect the lens.
- Moiré may occur when shooting a subject against bright light or if a bright light source is in the frame. In this case, remove the filter before shooting.

## **Speedlight SB-28/SB-27**

- Speedlight SB-28/SB-27 normally uses four AA-type alkaline-manganese batteries with a guide number of 36/118 (SB-28) and 30/98 (SB-27) (manual flash, 35mm zoom-head position, ISO 100, m/ft., 20°C/68°F). Optional external power source SD-7 and SD-8A or Power Bracket SK-6A (SB-28 only) can also be used.
- Matrix Balanced Fill-Flash, which enables natural-looking overall exposures and a better balance between ambient light and the fill-flash is compatible with the SB-28/SB-27. Also, the AF-Assist Illuminator enables autofocus operation in a dark environment.
- Automatic power zoom continuously changes the zoom-head position according to the lens' focal length. Also, a variety of flashes, including Slow Sync, Rear-Curtain Sync, non-TTL Auto Flash or manual flash is compatible with the SB-28/SB-27. With the SB-28, Repeating Flash is also available.

## **Wireless Slave Flash Controller SU-4**

- TTL multi-flash, where a Speedlight to which Wireless Slave Flash Controller SU-4 is attached is fired simultaneously with the built-in Speedlight or optional Speedlight attached to the N65/N65QD, can also be used. Both Diffuser SG-1 and SG-2 can be used.

## **Soft case (CF-61)**

- Camera case CF-61 is available for this camera. The camera body fits inside the case with AF 28-80mm f/3.5-5.6D IF or smaller lens attached.

## **Neckstraps/Handstrap AH-4**

- Braid-type AN-4B (black) and AN-4Y (yellow), wide braid-type AN-6Y (yellow) and AN-6W (burgundy) neckstraps are available.
- Handstrap AH-4 helps you hold the camera firmly and easily, and shoot in quick-motion.

# Camera Care

## • **Cleaning camera body**

Use a blower brush to remove dirt and dust from the camera body and clean it with a soft, clean cloth. After using the camera near seawater, wipe the camera body with a soft, clean cloth slightly moistened with pure water to remove salt, and then dry it with a dry cloth. **NEVER** use organic solvents like thinner or benzene. They may damage the camera.

## • **Cleaning mirror and lens**

Use a blower brush to remove dirt and dust from the mirror or lens. To remove fingerprints or smudges from the lens' surface, use a soft, clean cotton cloth or lens tissue moistened with ethanol (alcohol) or lens cleaner.

## • **Do not subject the camera or lens to strong vibration or shock**

Do not drop the camera body and lens or hit them against a hard surface as this may damage their precision mechanism.

## • **Do not touch the shutter curtains**

The shutter is made of very thin curtains. Do not hold, poke, or blow strongly with a blower brush. Doing so may scratch, deform or tear the shutter curtains.

## • **Avoid strong electric or magnetic fields**

The camera may not function properly in strong electric or magnetic fields such as near a transmitter tower. Avoid using the camera in such locations.

## • **Store the camera in a cool, dry place**

Store the camera in a cool, dry place to prevent mold and mildew.

Keep it away from naphthalene or camphor (moth repellent), electrical appliances that generate magnetic fields or an excessively hot place such as inside a vehicle during the summer or near a heater.

## • **Avoid extreme temperature change**

An extreme temperature change can cause condensation inside the camera body. When taking the camera to a very hot place from a very cold place or vice versa, place it inside an airtight container such as a plastic bag and leave it inside a while to expose the camera gradually to the temperature change.

## • **Avoid water or moisture**

Keep the camera away from water or moisture. When using the camera near water, guard against splashes, especially salt water spray.



## • Remove the batteries and store the camera with a desiccant

If you do not intend to use the camera for a long time, remove the batteries to protect the camera from battery leakage.

- In a humid environment, store the camera inside a plastic bag with a desiccant to keep out dust, moisture and salt. Note, however, that storing leather cases in vinyl bags may cause the leather to deteriorate. Keep the batteries in a cool, dry place away from heat or humidity.
- Change the desiccant occasionally since it does not absorb moisture effectively after a while.
- Leaving the camera unused for a long period of time may cause mold to grow and result in malfunction. Turn the power on and release the shutter a few times once per month.
- To maintain the built-in Speedlight in peak condition, fire it a few times every month. This will enable you to use the flash for many years.

Nikon cannot be held responsible for any malfunction resulting from the use of the camera other than as specified in this manual.

# Notes on Batteries



**WARNING**



Do not leave

Keep batteries out of children's reach.

If someone accidentally swallows batteries, call a doctor immediately.

---

## • Use two CR2-type 3V lithium batteries

Use two CR2-type 3V lithium batteries.

- Change the batteries well before the end of their life and prepare spare batteries before important photographic occasions.

---

## • Turn the camera power off when changing batteries

Turn the camera power off before changing batteries and insert the batteries with ⊕ and ⊖ ends positioned correctly.

- Stains on the battery poles may cause lack of contact. Wipe the batteries well with a dry cloth before installing.

---

## • Use fresh batteries at low temperatures

Battery power diminishes at extremely low temperatures and the camera may not function properly with old batteries. Use a fresh set of batteries at low temperatures, keep spare batteries warm, and use them alternately.







- Film advance speed lowers and number of usable film rolls becomes less at low temperatures. However, battery power may recover when the temperature returns to normal.

---

## • Do not throw batteries into a fire or short circuit batteries

Do not throw batteries into a fire. Do not short, disassemble, heat or charge batteries.

# Troubleshooting

LCD panel	Viewfinder	Cause	Remedy	Page
<i>fE E</i> blinks	<i>fE E</i> blinks	<ul style="list-style-type: none"> <li>• CPU Nikkor lens other than G-type is not set to its minimum aperture.</li> </ul>	<ul style="list-style-type: none"> <li>• Set lens to minimum aperture.</li> </ul>	18
<i>fE E</i> blinks	<i>fE E</i> and  blink	<ul style="list-style-type: none"> <li>• Attached Speedlight is not set at TTL Auto Flash in , Vari-Program or <b>P</b> mode.</li> </ul>	<ul style="list-style-type: none"> <li>• Set the Speedlight flash mode to TTL, or set the camera's exposure mode to <b>S</b>, <b>A</b> or <b>M</b>.</li> </ul>	92
 appears	—	<ul style="list-style-type: none"> <li>• Batteries are nearing exhaustion.</li> </ul>	<ul style="list-style-type: none"> <li>• Have fresh ones ready.</li> </ul>	17
 blinks	—	<ul style="list-style-type: none"> <li>• Batteries are just about exhausted.</li> </ul>	<ul style="list-style-type: none"> <li>• Turn the power off and replace batteries with new ones.</li> </ul>	17
 and frame counter blink	—	<ul style="list-style-type: none"> <li>• Batteries are exhausted during film rewind.</li> </ul>	<ul style="list-style-type: none"> <li>• Replace batteries with new ones or recharge batteries and turn the power on again, then press two  film rewind buttons simultaneously for more than 1 sec. to start film rewind again. If this warning appears frequently, contact authorized Nikon dealer or service center.</li> </ul>	66
<i>F - -</i> blinks	<i>F - -</i> blinks	<ul style="list-style-type: none"> <li>• Non-CPU lens is attached or lens is not attached.</li> </ul>	<ul style="list-style-type: none"> <li>• Attach CPU lens (except IX-Nikkor). With a non-CPU lens, set the exposure mode to <b>M</b> and set the aperture with lens' aperture ring.</li> </ul>	19, 88, 89, 90
<i>E r r</i> and <i>E</i> blink	<i>E r r</i> and <i>E</i> blink	<ul style="list-style-type: none"> <li>• Film is not correctly advanced.</li> </ul>	<ul style="list-style-type: none"> <li>• Reload film.</li> </ul>	21
<i>E</i> blinks when exposure meter is turned on	<i>E</i> blinks when exposure meter is turned on	<ul style="list-style-type: none"> <li>• Film remains in the camera after film rewind is complete.</li> </ul>	<ul style="list-style-type: none"> <li>• Remove the film cartridge.</li> </ul>	33

# Troubleshooting—continued

LCD panel	Viewfinder	Cause	Remedy	Page
—	● blinks	<ul style="list-style-type: none"> <li>Autofocus is not possible.</li> </ul>	<ul style="list-style-type: none"> <li>Focus manually.</li> </ul>	45
H i appears	H i appears	<ul style="list-style-type: none"> <li>Overexposure warning (subject is too bright).</li> </ul>	<ul style="list-style-type: none"> <li>In <b>AUTO</b>, Vari-Program or <b>P</b> mode, use ND filter.</li> <li>In <b>S</b> mode, select faster shutter speed.</li> <li>In <b>A</b> mode, select smaller aperture (larger f-number). (If the warning indication remains after performing above remedies in <b>S</b> or <b>A</b> mode, use ND filter as well.)</li> </ul>	51-57 55 57
L o appears	L o appears	<ul style="list-style-type: none"> <li>Underexposure warning (subject is too dark).</li> </ul>	<ul style="list-style-type: none"> <li>In <b>P</b> mode, use flash.</li> <li>In <b>AUTO</b> or Vari-Program, cancel the Flash Cancel and use flash.</li> <li>In <b>S</b> mode, select slower shutter speed.</li> <li>In <b>A</b> mode, select larger aperture (smaller f-number). (If the warning indication remains after performing above remedies in <b>S</b> or <b>A</b> mode, use flash as well.)</li> </ul>	53 51, 36 55 57
—	Electronic analog exposure display blinks	<ul style="list-style-type: none"> <li>Subject brightness is beyond camera's exposure range.</li> </ul>	<ul style="list-style-type: none"> <li>When the subject is bright, use ND filter and when the subject is dark, use flash. The electronic analog exposure display remains blinking when the Speedlight is used.</li> </ul>	59

LCD panel	Viewfinder	Cause	Remedy	Page
-- blinks	-- blinks	<ul style="list-style-type: none"> <li>Shutter speed is set to -- (Time) in <b>S</b> mode.</li> <li>Auto Exposure Bracketing is set during Long Time exposure</li> </ul>	<ul style="list-style-type: none"> <li>Cancel the -- by selecting 30 sec. or faster shutter speed, or select <b>M</b> mode to perform Long Time Exposure.</li> <li>Select shutter speed other than -- to cancel Long Time exposure, or cancel Auto Exposure Bracketing</li> </ul>	54, 60  60, 63
Shutter speed indication blinks	<b>90</b> appears	<ul style="list-style-type: none"> <li>Shutter speed faster than sync speed is selected in <b>S</b> or <b>M</b> mode.</li> </ul>	<ul style="list-style-type: none"> <li>Simply release the shutter to take a flash picture. (Shutter speed automatically shifts to 1/90 sec.)</li> </ul>	80, 83
—	<b>⚡</b> blinks	<ul style="list-style-type: none"> <li>Subject is too dark and flash is recommended in <b>P</b>, <b>S</b>, <b>A</b> or <b>M</b> mode.</li> </ul>	<ul style="list-style-type: none"> <li>Use Speedlight.</li> </ul>	53, 55, 57, 59, 76, 80
—	<b>⚡</b> blinks for 3 sec. after flash	<ul style="list-style-type: none"> <li>Flash has fired at full output and underexposure may have occurred.</li> </ul>	<ul style="list-style-type: none"> <li>Shoot again after confirming focus distance, aperture or flash shooting distance range.</li> </ul>	77, 84
<b>Err</b> blinks	<b>Err</b> blinks	<ul style="list-style-type: none"> <li>Malfunction detected.</li> </ul>	<ul style="list-style-type: none"> <li>Release shutter again. If the warning indication remains, or this warning appears frequently, contact authorized Nikon dealer or service center.</li> </ul>	

In certain cases, due to static electricity, the N65/N65QD's microcomputer may turn the camera off, even with fresh, properly installed batteries. For the same reason, the film may not advance properly. In each of these cases, to resume operation, simply turn the power off, then turn it on again. Or, remove and reinstall the batteries.

## **CPU**

Central Processing Unit. The electronic component that controls an electronic product's functions.

AF Nikkor (including D- and G-type AF Nikkor) and AI-P-Nikkor lenses have built-in CPUs.

## **EV**

Exposure Value: A number representing the available combinations of shutter speeds and apertures that give the same exposure effect under conditions of similar scene brightness and ISO.

At ISO 100, the combination of a one-second shutter speed and an aperture of f/1.4 is defined as EV1.

The camera can be used only within the EV range of the exposure meter. For example, with the N65/N65QD, the exposure metering range is from EV1 to EV20 for 3D Matrix Metering and Center-Weighted Metering, at ISO 100 with an f/1.4 lens.

## **Exposure bracketing**

Shooting the same subject a number of times at a range of different exposures to attain proper exposure. Three shots with metered EV, under EV, and over EV exposure are performed in that order with the N65/N65QD.

Automatic exposure bracketing is performed with varied shutter speeds and/or apertures.

## **Exposure Compensation**

In a situation such as when your subject is strongly backlit, exposure compensation enables you to intentionally compensate the standard exposure value measured by the camera to create a desired effect. exposure compensation of -2 EV to +2 EV in 1/2 steps is available with the N65/N65QD.

### **Flash shooting distance range**

The distance range over which a flash can effectively provide light. Flash shooting distance range is controlled by the amount of flash output available. Each automatic Speedlight's flash output varies from maximum duration to minimum duration. Close-up subjects will require lower (to minimum) output, while more distant subjects will require more light up to the maximum output.

The flash shooting distance range varies with the aperture, film speed, etc.

### **Flash synchronization**

Timing of the flash so it coincides with release of the camera's shutter. There are two types of synchronization: Front-Curtain Sync, which fires the flash at the start of the exposure, and Rear-Curtain Sync, which fires the flash at the end of the exposure.

### **Flash sync speed**

Shutter speed at which the entire film frame is exposed when the flash is fired in flash shooting. The N65/N65QD's flash sync speed is 1/90 sec. or slower.

### **Flexible Program**

Flexible Program function temporarily shifts an automatically selected shutter speed/aperture combination while maintaining correct exposure. That is, the desired shutter speed or aperture can be selected in Auto-Multi Program.

### **f-number**

The f-number represents the aperture value and is calculated from lens' focal length divided by the effective aperture opening. The standard numbers for calibration are 1, 1.4, 2, 2.8, 4, 5.6, 8, 11, 16, 22, 32, etc.

The smallest f-number is called maximum aperture and the largest f-number is called minimum aperture. Lenses with large maximum apertures (smaller f-numbers) are 'fast' lenses that allow photographers to use faster shutter speeds in dim light. Lenses with smaller maximum apertures (larger f-numbers) allow the use of lower shutter speeds for available light but are also lighter and smaller than faster lenses.

## Focus Tracking

Enables the camera to analyze the speed of a moving subject according to the focus data detected, and to obtain correct focus by anticipating the subject's position—at the exact moment of exposure.

Lock-On™ Autofocus keeps focus firmly on a main subject during Focus Tracking even if some other object momentarily blocks it in the viewfinder.

## Focal length

The distance from the principal point to the focal point. In 35mm-format cameras, lenses with a focal length of approx. 50mm are called normal or standard lenses. Lenses with a focal length less than approx. 35mm are called wideangle lenses, and lenses with a focal length more than approx. 85mm are called telephoto lenses. Lenses which allow the user to continuously vary the focal length without changing focus are called zoom lenses.

## Front-Curtain Sync

The flash fires an instant after the front curtain of a focal plane shutter has completed its travel across the film plane. This is the way the N65/N65QD operates with the flash sync mode at Normal Sync. (See “Rear-Curtain Sync”.)

## Guide number

The guide number indicates the power of a flash in relation to ISO film speed. Guide numbers are quoted in either meters or feet. Guide numbers are used to calculate the f/stop for correct exposure as follows:

$$f/\text{stop} = \frac{\text{guide number}}{\text{flash-to-subject distance}}$$

Using a selected aperture, we can calculate the required flash-to-subject distance with the formula:

$$\text{flash-to-subject distance} = \frac{\text{guide number}}{f/\text{stop}}$$

Useful for determining the maximum flash-to-subject distance for flash photography.





## ISO film speed

The international standard for representing film sensitivity. The higher the number, the greater the sensitivity, and vice versa. A film speed of ISO 200 is twice as sensitive as ISO 100, and half that of ISO 400 film.

## Rear-Curtain Sync

Flash fires an instant before the second (rear) curtain of the focal plane shutter begins to move. When slow shutter speeds are used, this feature can create a blur effect from the ambient light, i.e., flowing-light patterns following a moving subject with subject movement frozen at the end of the light flow. (See “Front-Curtain Sync”.)

## Slow Sync







A flash technique for using the flash at a slow shutter speed. Flash shooting in dim light or at night at a fast shutter speed often results in a flash-illuminated subject against a dark background. Using a slower shutter speed with the flash brings out the background details in the picture. Use of a slow shutter speed with Rear-Curtain Sync is particularly effective for illustrating the movement of a stream of light.



The N65/N65QD’s Slow Sync mode extends the automatically controlled shutter speed range down to 30 sec. (in Auto-Multi Program, Aperture-Priority Auto) or 1 sec. (in  Night Scene mode).

## Vignetting

Progressively diminished illumination on the film from the center to the corners. There are two kinds of vignetting—natural vignetting caused by the lens, and vignetting that is caused by improper use of accessories such as a lens hood or filter.

# Specifications

Type of camera	Integral-motor autofocus 35mm single-lens reflex with electronically controlled focal-plane shutter and built-in Speedlight
Exposure modes	<p>: AUTO mode            Vari-Program (: Portrait, : Landscape, : Close-Up, : Sports Continuous, : Night Scene mode)  <b>P</b>: Auto-Multi Program (Flexible Program possible)  <b>S</b>: Shutter-Priority Auto  <b>A</b>: Aperture-Priority Auto  <b>M</b>: Manual</p>
Picture format	24 x 36mm (standard 35mm film format)
Lens mount	Nikon F mount (with AF coupling, AF contacts)
Lens	CPU Nikkor lens, non-CPU Nikkor lens* * With limitations; see chart on page 89.
Viewfinder	Fixed eye-level pentaprism, built-in diopter adjustment (-1.5 to +0.8m <sup>-1</sup> )
Eyepoint	17mm (at -1.0m <sup>-1</sup> )
Focusing screen	B-type Clear Matte Screen V with focus brackets
Viewfinder frame coverage	Approx. 89%
Finder magnification	Approx. 0.68-0.60x with 50mm lens set to infinity (at -1.5 to +0.8m <sup>-1</sup> )
Viewfinder information	Focus indications, focus area, shutter speed, aperture, electronic analog exposure display/Exposure Compensation value display, Exposure Compensation, flash ready-light/flash recommended/full flash output Five sets of focus brackets (area)/12mmø reference circle for Center-Weighted metering
Reflex mirror	Automatic, instant-return type
Lens aperture	Instant-return type, with depth-of-field preview button



Autofocus	TTL phase detection, Nikon Multi-CAM900 autofocus module with AF-Assist Illuminator (approx. 0.5m-3m or 1.6-9.8 ft.) • Detection range: EV -1 to EV 19 (ISO 100, at normal temperature)
Lens servo	<b>AF:</b> Auto-Servo AF: camera automatically chooses Single Servo AF or Continuous Servo AF operation according to the subject status, i.e. stationary or moving (including directional information). • Single Servo AF (focus is locked when the subject is in-focus) • Continuous Servo AF (camera continues to focus on a moving subject) Focus Tracking with Lock-On™ automatically activated by subject's status <b>M:</b> Manual focus
Focus area	One of five focus areas can be selected
Focus Area mode	• Dynamic AF Mode with Closest-Subject Priority • Dynamic AF Mode • Single Area with <b>M</b> focus mode
Metering system	TTL full-aperture exposure metering system Three metering systems selectable (limitations with lens used) • 3D six-segment Matrix Metering: with D- or G-type AF Nikkor • Six-segment Matrix Metering: with AF Nikkor other than D- or G-type (except AF Nikkor for F3AF and IX-Nikkor), AI-P Nikkor • Center-Weighted Metering: automatically selected with Manual exposure mode
Metering range	3D Matrix Metering: EV 1-20 Center-Weighted Metering: EV 1-20 (at normal temperature, ISO 100, f/1.4 lens)
Exposure meter coupling	CPU
Exposure Compensation	Exposure compensated in $\pm 2$ EV range, in 1/2 steps (except in <b>M</b> or  )
Auto Exposure Bracketing	Bracketing range: $\pm 2$ EV; number of shots: three; bracketing steps: 0.5, 1, 1.5 or 2 EV (except in  or Vari-Program)
Film speed setting	• Automatically set to ISO film speed of DX-coded film in use (manual not selectable) • Film speed range: DX: ISO 25-5000, automatically set to ISO 100 with non-DX-coded film



Depth-of-field preview button	Stop-down lens aperture by pressing depth-of-field button; electronically controlled
Film loading	Film automatically advances to first frame when camera back is closed (shutter and reflection mirror not activated)
Film advance	<ul style="list-style-type: none"> <li>• Automatic advance with built-in motor</li> <li>• Continuous shooting possible in  Sports Continuous mode (built-in Speedlight cannot be used)</li> <li>• Film advance speed: approx. 2.5 fps (fresh batteries)</li> </ul>
Film rewind	<ul style="list-style-type: none"> <li>• Automatic rewind with built-in motor</li> <li>• Rewind speed with fresh batteries: approx. 16 sec. with 36-exposure film, approx. 13 sec. with 24-exposure film</li> </ul>
Multiple Exposure	Selectable in <b>P, S, A, M</b>
LCD panel information	Shutter speed, aperture, Exposure Compensation, Exposure Compensation value, Auto Exposure Bracketing, Multiple Exposure, flash sync mode, focus area, battery power, frame counter, self-timer, remote control
Date/time imprint function (N65QD only)	<p>Built-in clock: 24-hour type with timing accuracy within <math>\pm 90</math> seconds a month; leap year adjustment until December 31, 2049</p> <p>Usable film: ISO 32 to 3200 DX-coded film</p> <p>Display mode: Year/Month/Day, Day/Hour/Minute, No Imprint, Month/Day/Year and Day/Month/Year</p> <p>Power source: one 3V CR2025 lithium battery, battery life; approx. three years (depending upon use of data imprint function and other operating conditions)</p>
Camera back	Hinged back with film confirmation window N65QD: data imprint LCD panel/buttons
Power source	Two 3V CR2 lithium batteries; optional Battery Pack MB-17 is also available (for four AA-type alkaline-manganese, lithium, NiCd or Ni-MH batteries)
Power switch	Power ON and OFF position
Exposure meter	Auto meter shut-off 5 sec. after power turned on if no operations are performed; activated by lightly pressing shutter release button after power is turned on

# Specifications—continued



<b>Battery power confirmation</b>	In LCD panel, with exposure meter on <ul style="list-style-type: none"> <li>•  for sufficient power</li> <li>•  indicates batteries are nearing exhaustion</li> <li>• Blinking  indicates batteries are just about exhausted</li> </ul>		
<b>Usable number of 36-exposure (24-exposure) film rolls per set of two fresh 3V lithium batteries</b>		At 20°C/68°F	At -10°C/14°F
	Without flash	Approx. 50 (75)	Approx. 25 (37)
	With flash and AF-Assist Illuminator for half of all exposures	Approx. 10 (15)	Approx. 7 (10)
<i>Autofocus operation using an AF Zoom-Nikkor 28-80mm f/3.5-5.6D lens, covering the full range from infinity (∞) to the closest distance and back to infinity (∞) before each shot, with a shutter speed of 1/90 sec. or faster.</i>			
<b>Tripod socket</b>	1/4 (diameter, JIS standard)		
<b>Dimensions (W x H x D)</b>	N65:     Approx. 139.5 x 92.5 x 65.5mm (5.5 x 3.6 x 2.6 in.) N65QD:  Approx. 139.5 x 92.5 x 68mm (5.5 x 3.6 x 2.7 in.)		
<b>Weight (without batteries)</b>	N65:     Approx. 395g (13.9 oz.) N65QD:  Approx. 400g (14.1 oz.)		
<b>Optional exclusive accessories</b>	Battery Pack MB-17, Soft case CF-61, Remote control unit ML-L3		

*All specifications apply when fresh batteries are used at normal temperature (20°C/68°F).*

*Specifications and design are subject to change without notice.*



## A

- AF-Assist Illuminator .....31, 35, 48-49, 73, 82, 92-93
- Aperture-Priority Auto exposure mode .....10, 29, 56-57, 73, 86
- Auto Exposure Bracketing .....62-63, 73
- Autofocus .....26, 44
- AUTO mode ..... 11, 29, 51, 52, 73, 86
- Auto-Multi Program .....10, 29, 52-53, 73, 86
- Auto-Servo AF .....44

## C

- Center-Weighted Metering .....9, 42, 58
- Continuous shooting .....38, 73
- Continuous Servo AF .....44
- CPU Nikkor lens .....18, 88-89

## D

- Depth of field .....56, 74
- Diopter adjustment .....67
- Distance information .....28, 42
- D-type Nikkor lens .....18, 88
- DX-coded film .....21
- Dynamic AF Mode .....46, 73
- Dynamic AF Mode with Closest Subject Priority .....26, 46, 73

## E

- Exposure Compensation .....61, 73, 102
- Exposure meter .....17, 21
- Exposure mode .....10-11, 28-29, 51-60, 73, 83, 86, 89

## F

- Film advance mode .....73
- Flash Cancel .....34, 79
- Flash shooting distance range .....84, 103
- Flash sync mode .....78-79, 81, 86
- Flexible Program .....53, 73, 103
- Focus brackets (area) .....8, 9, 30, 46-47
- Focus Lock .....27, 50
- Focus mode .....26, 44-45, 73, 89
- Focus Tracking .....44, 104
- Front-Curtain Sync .....35, 78, 86, 104

## G

- G-type Nikkor lens .....18, 88
- Guide number .....35, 76, 84, 104

## L

- Long Time exposure (Time) .....60, 71



<b>M</b>	
Manual exposure mode .....	10, 29, 58-60, 73, 86
Manual focus.....	27, 45
Manual focus with electronic rangefinder .....	45
Matrix Balanced Fill-Flash .....	35, 76, 86, 91
Matrix Metering .....	28, 42
Maximum aperture .....	56, 58
Metering system .....	28, 42, 58, 73, 89
Minimum aperture.....	18, 52-58, 88
Multiple Exposure .....	64-65, 73
<b>R</b>	
Ready-light.....	9, 34, 77, 80, 82
Rear-Curtain Sync.....	78, 86, 91, 92, 105
Red-Eye Reduction .....	41, 70, 79, 86, 91, 92
Red-Eye Reduction with Slow Sync .....	79, 86, 92
Remote control operation .....	69-72

<b>S</b>	
Self-timer .....	40-41
Shutter-Priority Auto exposure mode .....	10, 29, 54-55, 73, 86
Single Area Mode.....	47, 73
Single-frame shooting .....	73
Single Servo AF.....	44
Slow Sync flash .....	78, 86, 92, 105
Standard TTL flash.....	76, 86
Sync shutter speed .....	83
<b>T</b>	
3D 6-Segment Matrix Metering ....	28, 42
<b>V</b>	
Vari-Program.....	11, 29, 36-38, 73, 86
Vignetting .....	49, 85, 105





No reproduction in any form of this manual, in whole or in part (except for brief quotation in critical articles or reviews), may be made without written authorization from NIKON CORPORATION.

***Nikon***

**NIKON CORPORATION**

FUJI BLDG., 2-3, MARUNOUCHI 3-CHÔME,  
CHIYODA-KU, TOKYO 100-8331, JAPAN